

Experimentation and Modeling of Concrete Crossties and Fastening Systems

Wheel Rail Interaction Conference

8-9 May 2013

Chicago, IL USA

J. Riley Edwards and Brandon Van Dyk

RAILTEC
UNIVERSITY OF ILLINOIS AT URBANA-CHAMPAIGN



Outline

- Background and Research Justification
- RailTEC Concrete Crosstie Research
- Mechanistic Design Introduction
- Key Research Thrust Areas and Summary of Results
 - Laboratory Instrumentation
 - Field Instrumentation
 - Analytical Methods (FEA)
- Future Work
- Acknowledgements



Outline

- Background and Research Justification
- RailTEC Concrete Crosstie Research
- Mechanistic Design Introduction
- Key Research Thrust Areas and Summary of Results
 - Laboratory Instrumentation
 - Field Instrumentation
 - Analytical Methods (FEA)
- Future Work
- Acknowledgements



Concrete Crossties – Overview of Use

- Typical Usage:
 - Freight → Heavy tonnage lines, steep grades, and high degrees of curvature
 - Passenger → High density corridors (e.g. Amtrak's Northeast Corridor [NEC])
 - Transit applications
 - Number of concrete ties in North America*:
 - Freight → 25,000,000
 - Passenger → 2,000,000
 - Transit → Significant quantities (millions)
- *Approximate*



Fastening System Components

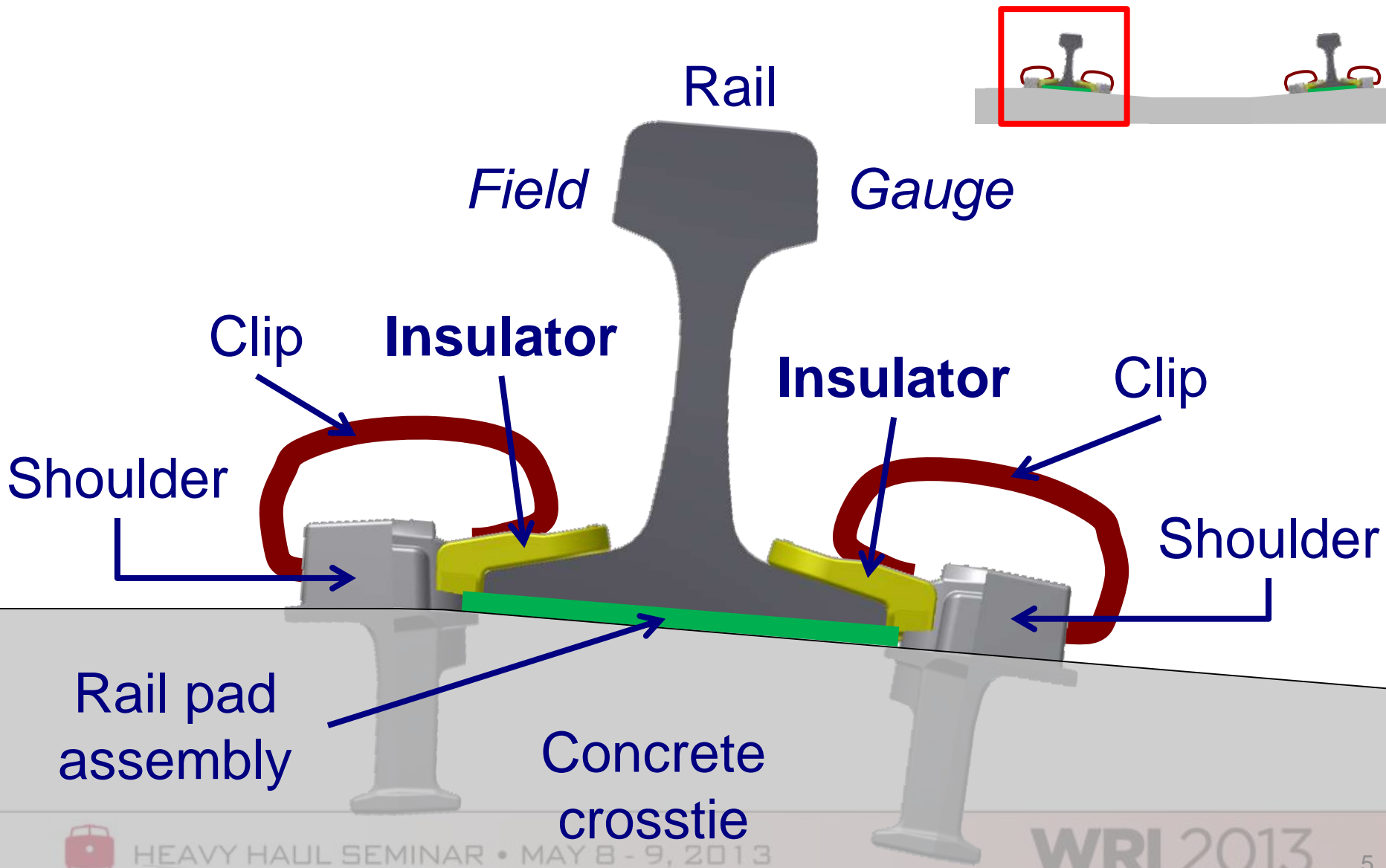

Complete System

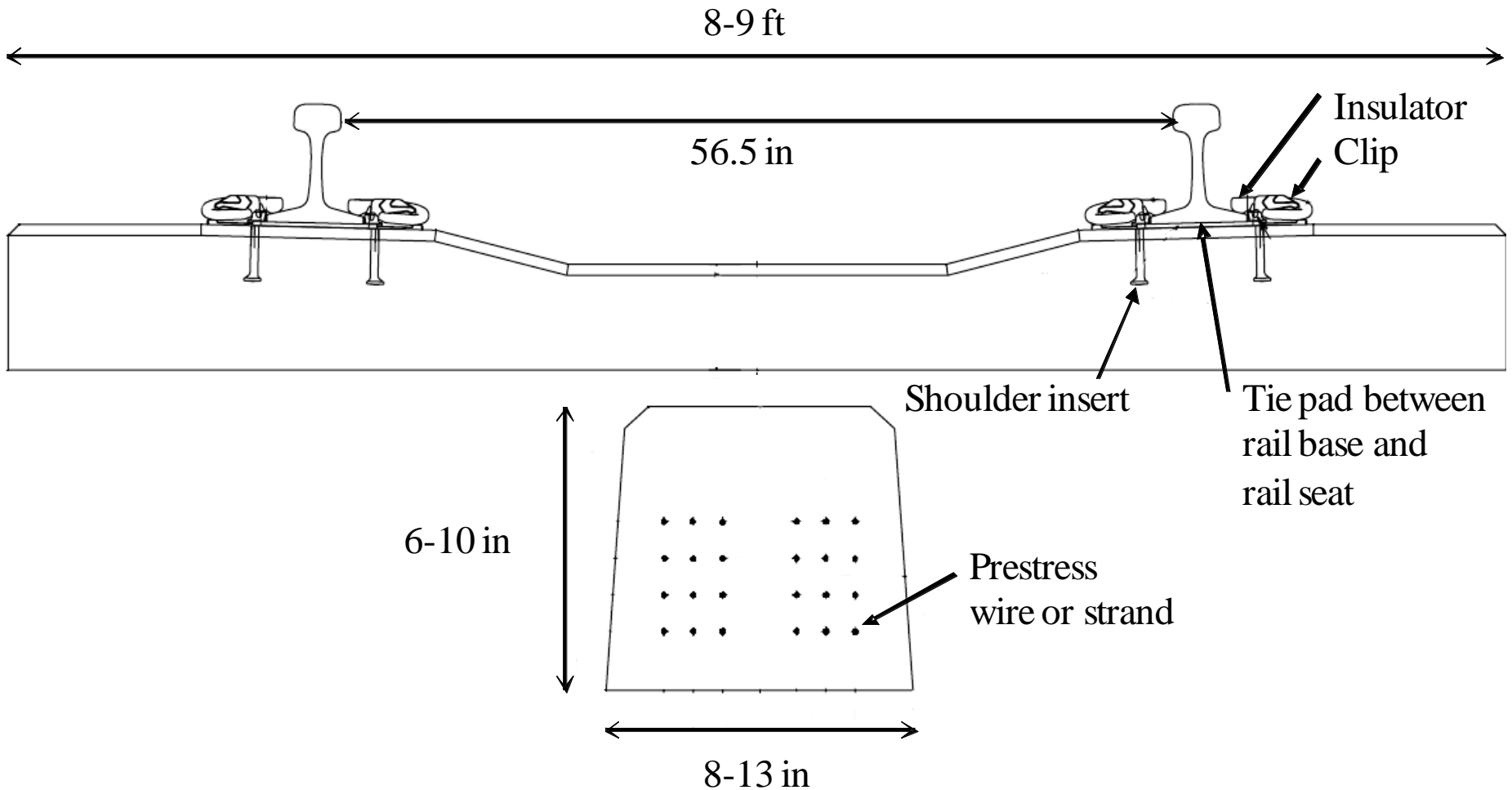

Outline

- Background and Research Justification
- **RailTEC Concrete Crosstie Research**
- Mechanistic Design Introduction
- Key Research Thrust Areas and Summary of Results
 - Laboratory Instrumentation
 - Field Instrumentation
 - Analytical Methods (FEA)
- Future Work
- Acknowledgements



Concrete Crosstie and Fastener Research Levels (and Examples)

Materials

Concrete Mix Design

Rail Seat Surface Treatments

Pad / Insulator Materials

Components

Fastener Yield Stress

Insulator Post Compression

Concrete Prestress Design

System

Finite Element Modeling

Full-Scale Laboratory Experimentation

Field Experimentation



2012 International Survey Results – Criticality of Problems

Problem (higher ranking is more critical)	Average Rank
International Responses	
Tamping damage	6.14
Shoulder/fastening system wear or fatigue	5.50
Cracking from center binding	5.36
Cracking from dynamic loads	5.21
Cracking from environmental or chemical degradation	4.67
Derailment damage	4.57
Other (e.g. manufactured defect)	4.09
Deterioration of concrete material beneath the rail	3.15
North American Responses	
Deterioration of concrete material beneath the rail	6.43
Shoulder/fastening system wear or fatigue	6.38
Cracking from dynamic loads	4.83
Derailment damage	4.57
Cracking from center binding	4.50
Tamping damage	4.14
Other (e.g. manufactured defect)	3.57
Cracking from environmental or chemical degradation	3.50

Outline

- Background and Research Justification
- RailTEC Concrete Crosstie Research
- **Mechanistic Design Introduction**
- Key Research Thrust Areas and Summary of Results
 - Laboratory Instrumentation
 - Field Instrumentation
 - Analytical Methods (FEA)
- Future Work
- Acknowledgements



Current Design Process

- Found in AREMA Manual on Railway Engineering
- Based largely on practical experience:
 - Lacks complete understanding of failure mechanisms and their causes
 - Empirically derives loading conditions (or extrapolates existing relationships)
- Can be driven by production and installation practices
- Improvements are difficult to implement without understanding complex loading environment

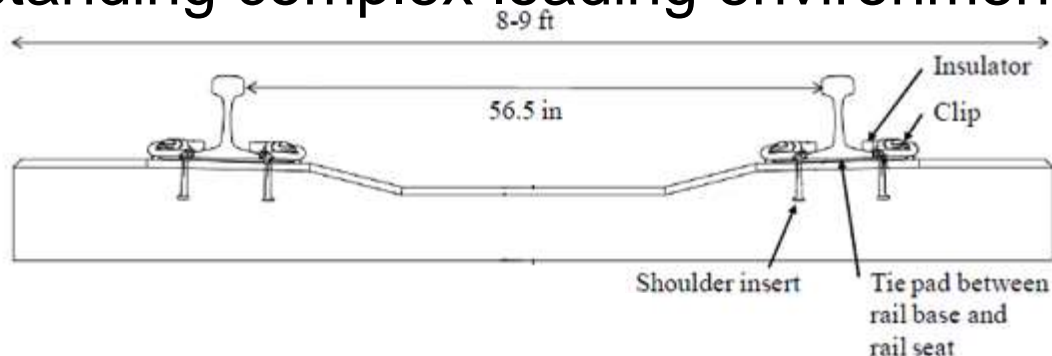

Principles of Mechanistic Design

1. Quantify track system input loads (wheel loads)
2. Qualitatively establish load path (free body diagrams, basic modeling, etc.)
3. Quantify demands on each component
 - a. Laboratory experimentation
 - b. Field experimentation
 - c. Analytical modeling
4. Link quantitative data to component geometry and materials properties (materials decision)
5. Relate loading to failure modes
6. Investigate interdependencies through modeling
7. Establish mechanistic design practices and incorporate into AREMA Recommended Practices



Determining System Input Loads

- Quantitative methods of data collection (Step 1):
 - Wheel Impact Load Detectors (WILD)
 - Instrumented Wheel Sets (IWS)
 - Truck Performance Detectors (TPD)
 - UIUC Instrumentation Plan (FRA Tie BAA)
- Most methods above are used to monitor rolling stock performance and assess vehicle health
- Can provide insight into the magnitude and distribution of loads entering track structure
 - Limitations to WILD: tangent track (still need lateral curve data), good substructure (not necessarily representative of the broader rail network)



Vertical Wheel Loads – Shared Infrastructure

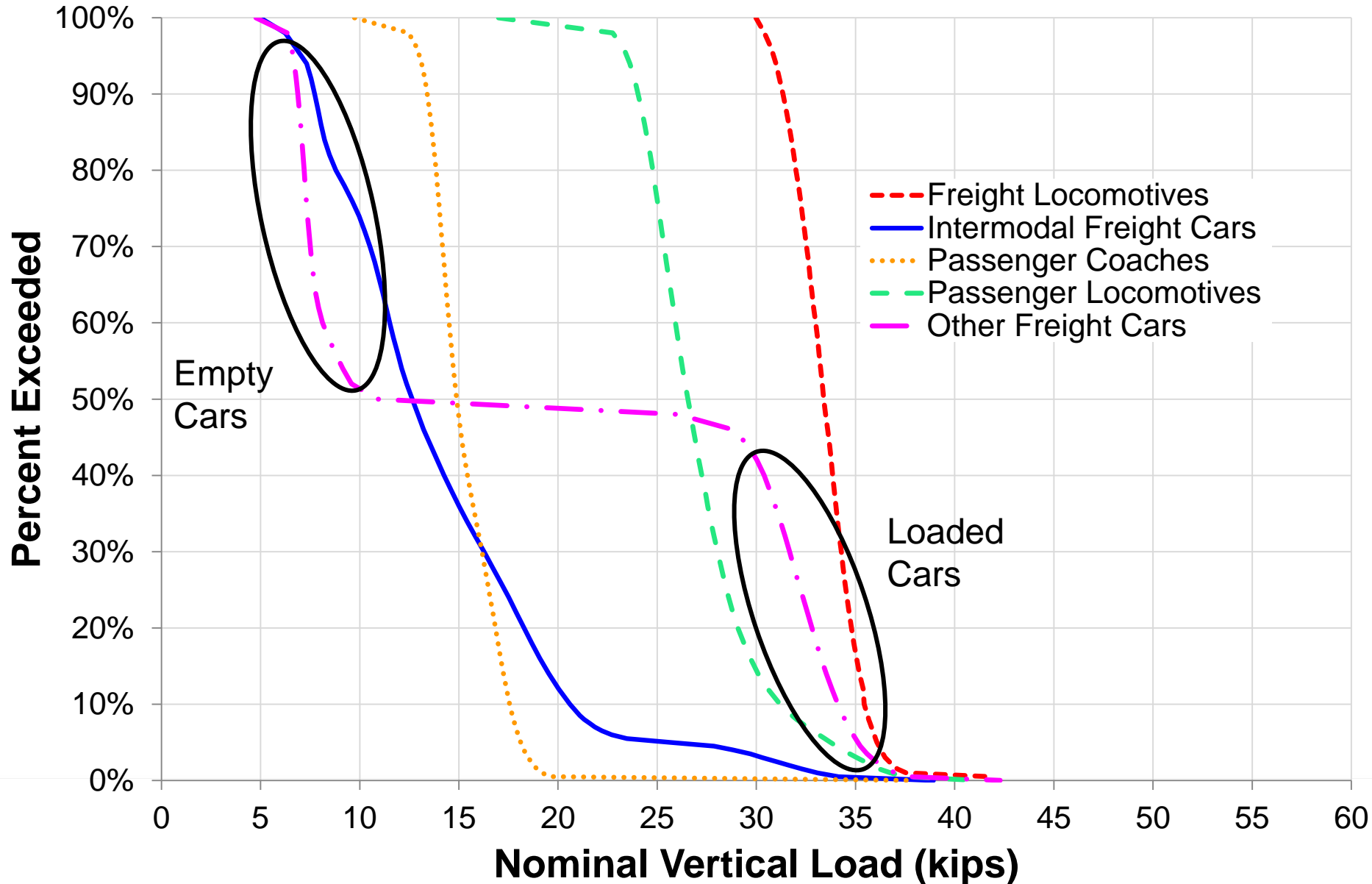

Effect of Traffic Type on Peak Wheel Load

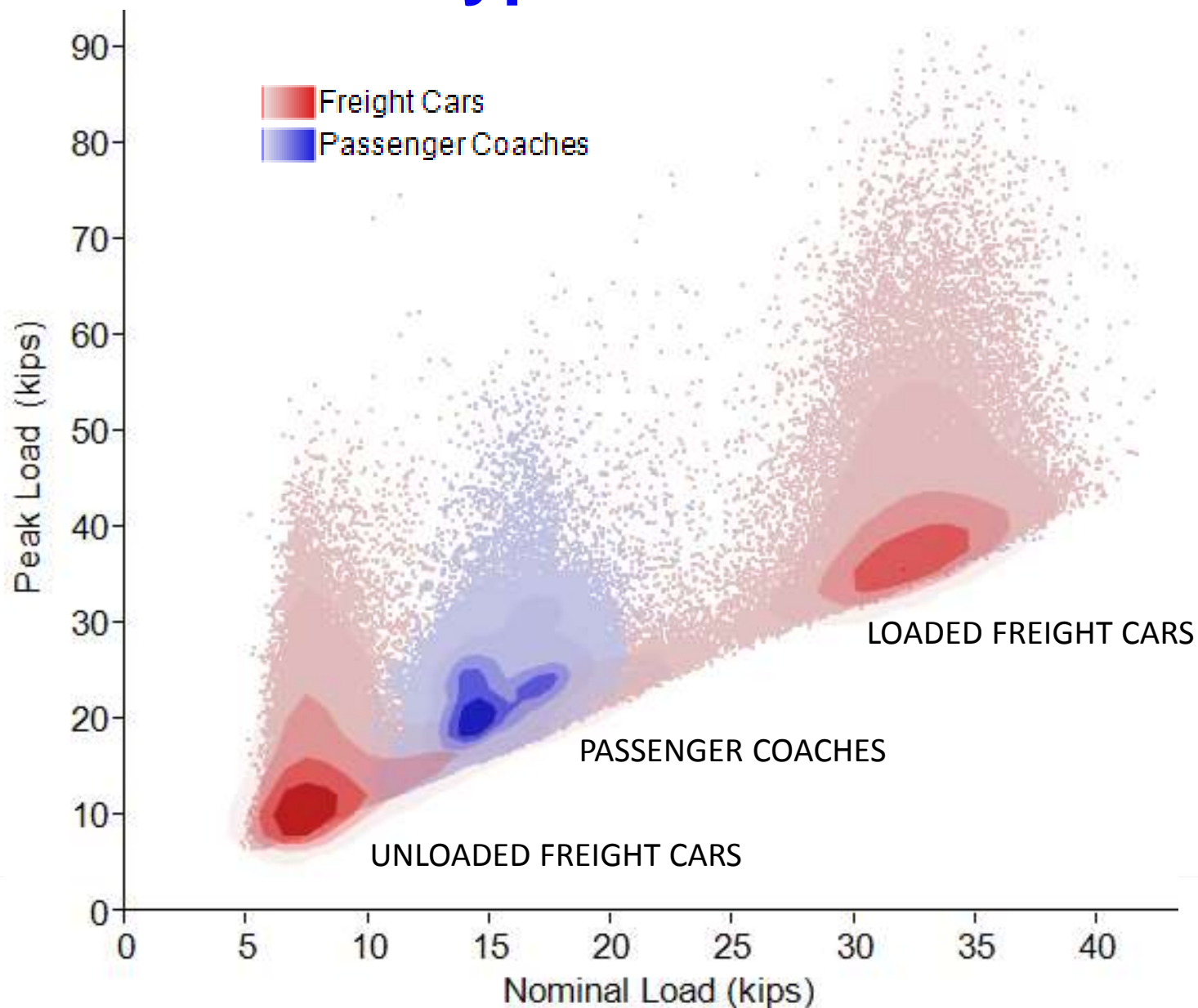

Dynamic Wheel Load Factors

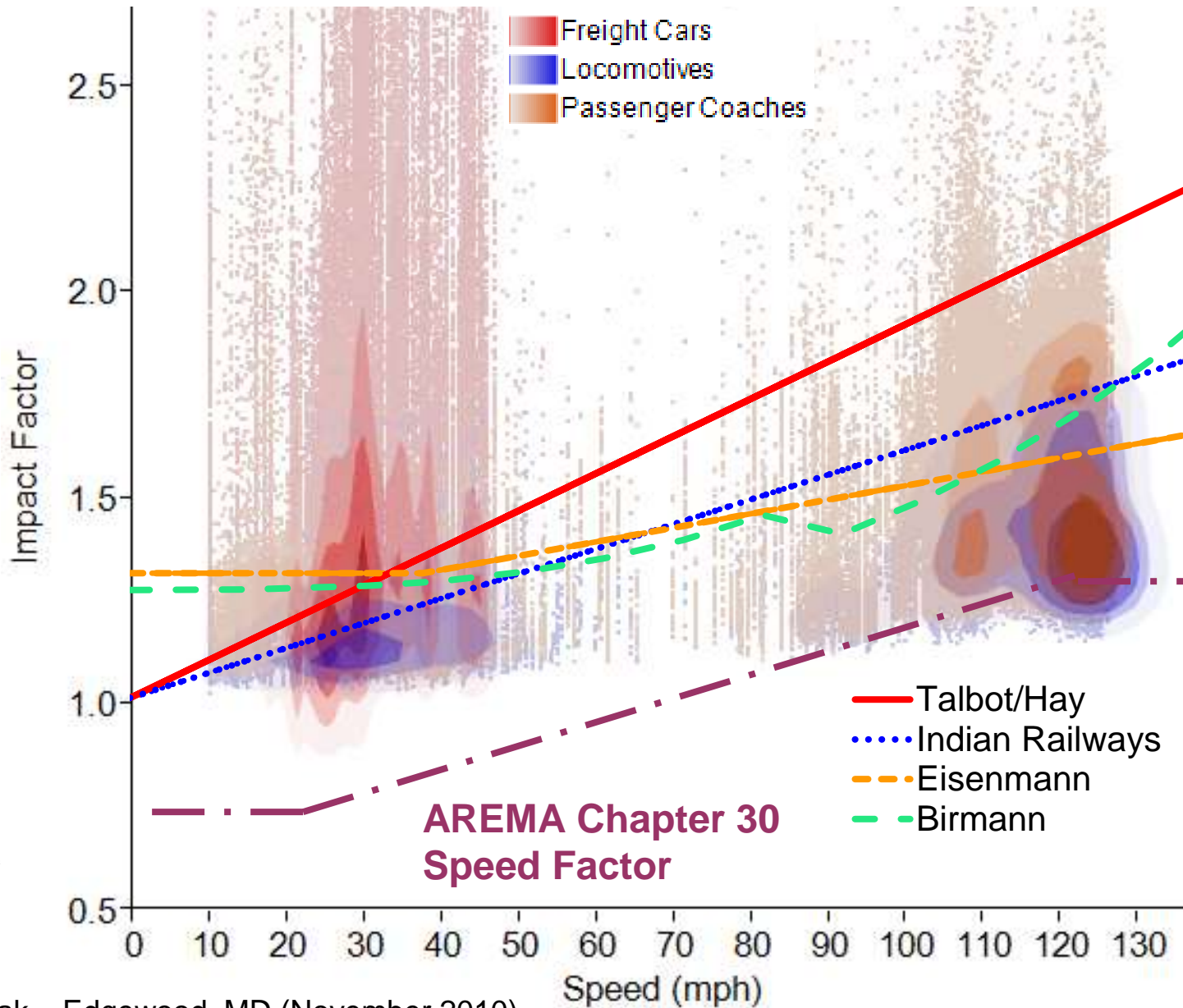

More than a Dynamic Factor: Impact Factor

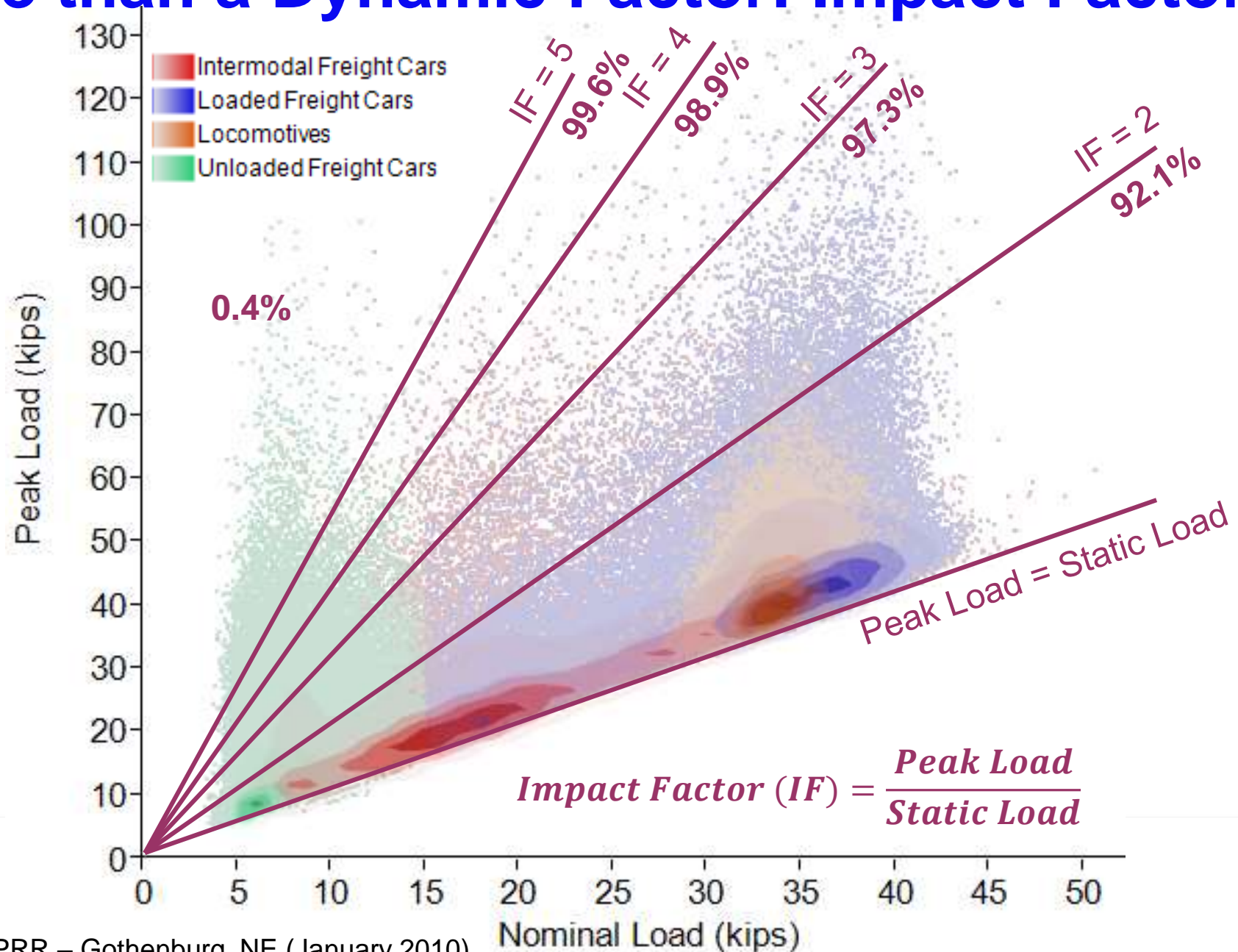

So What is Our Design Threshold?

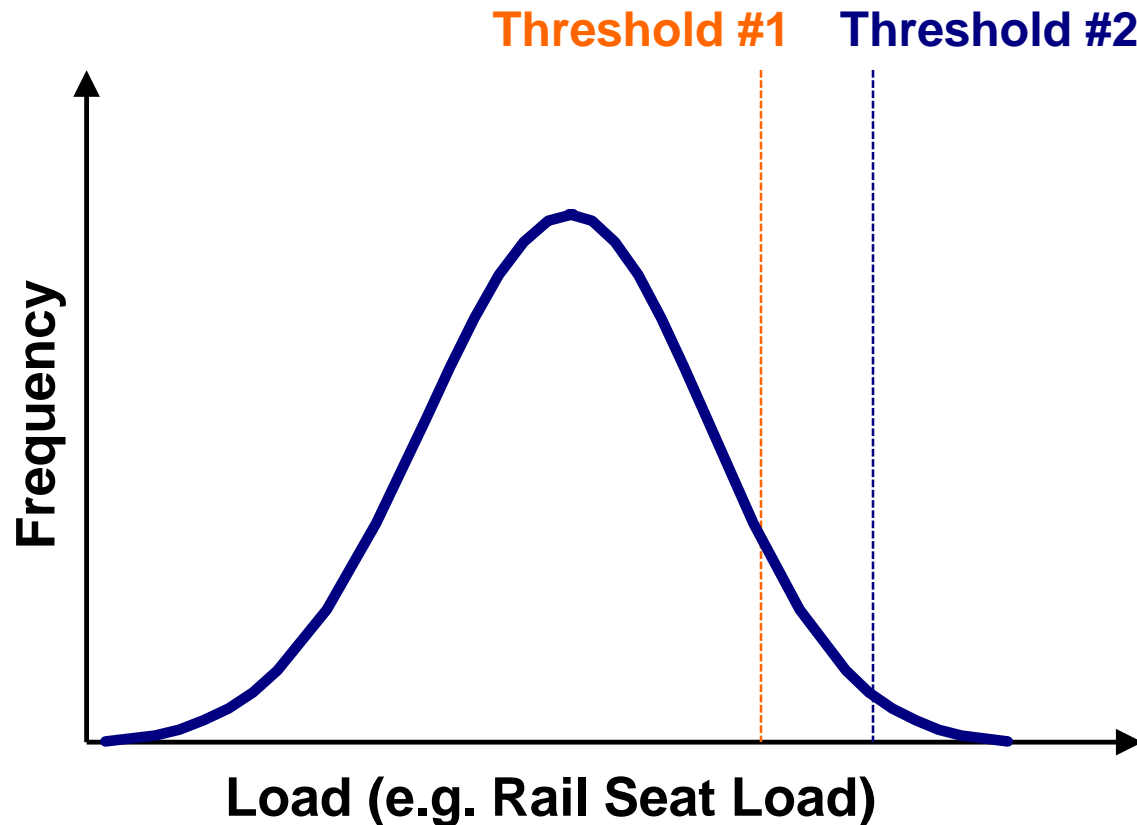

***Need curves for each component / interface and failure mode**



Development of Quantitative Loading Model

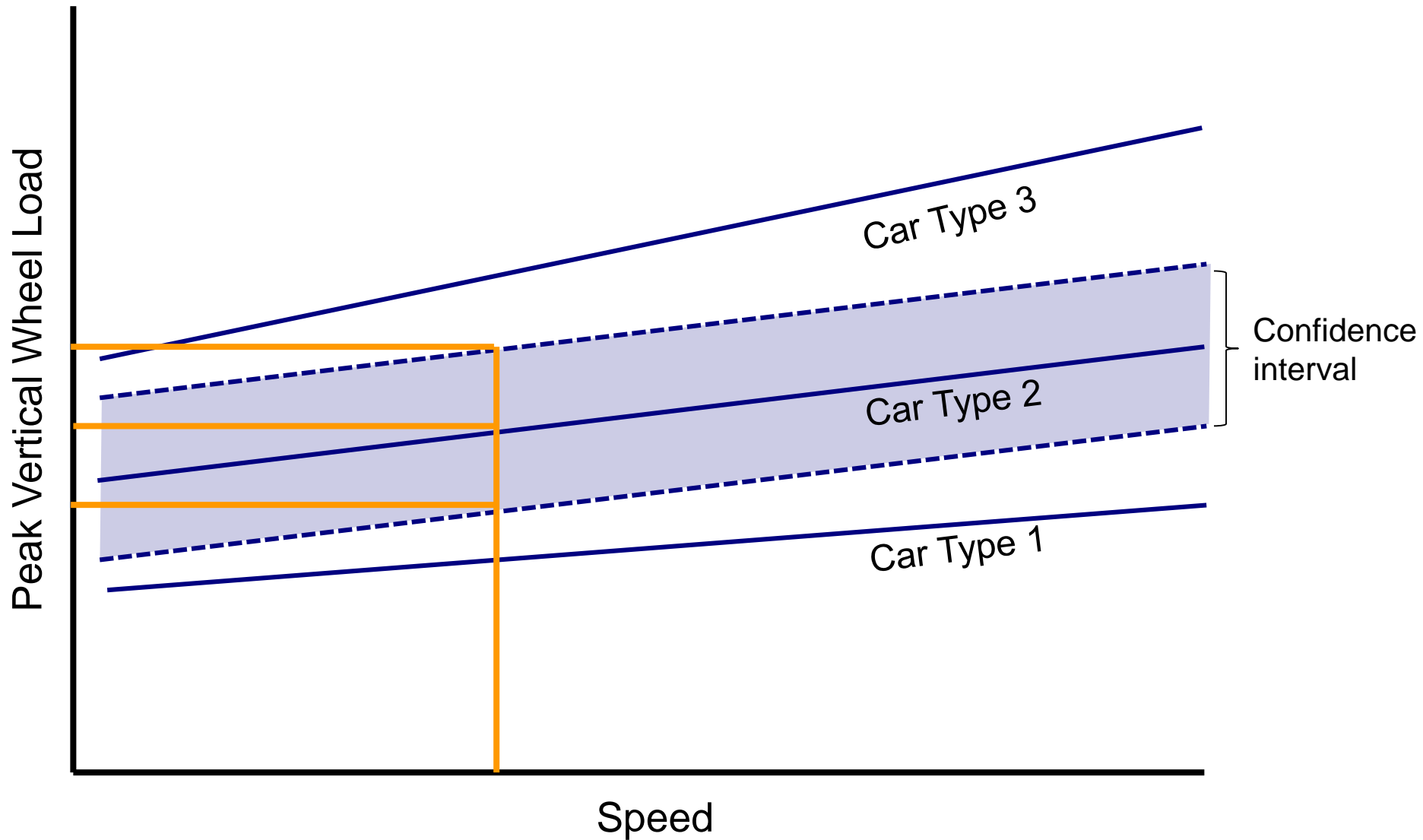

Development of Quantitative Loading Model

Conceptual Sketch

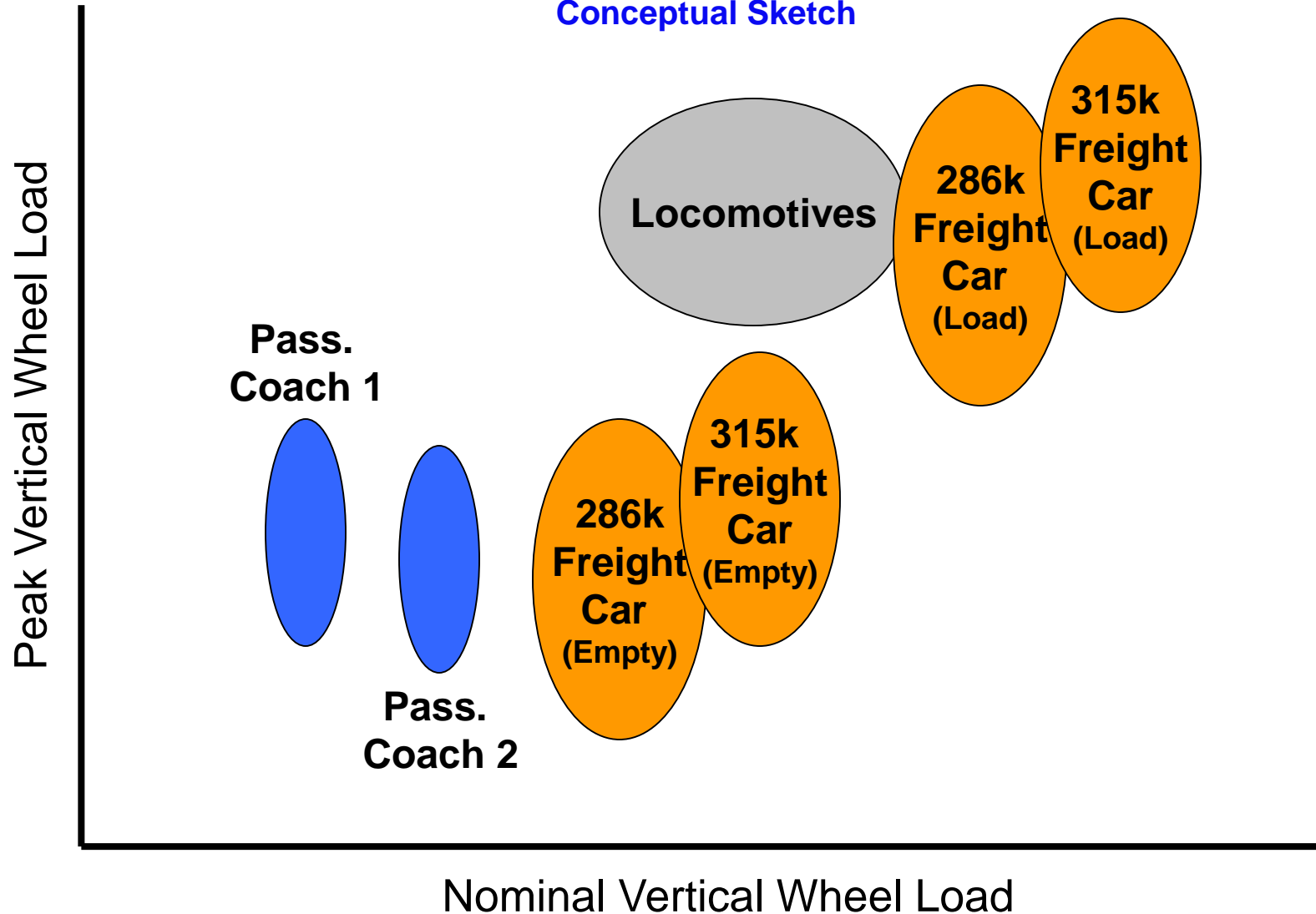

Establishment of the Qualitative Load Path

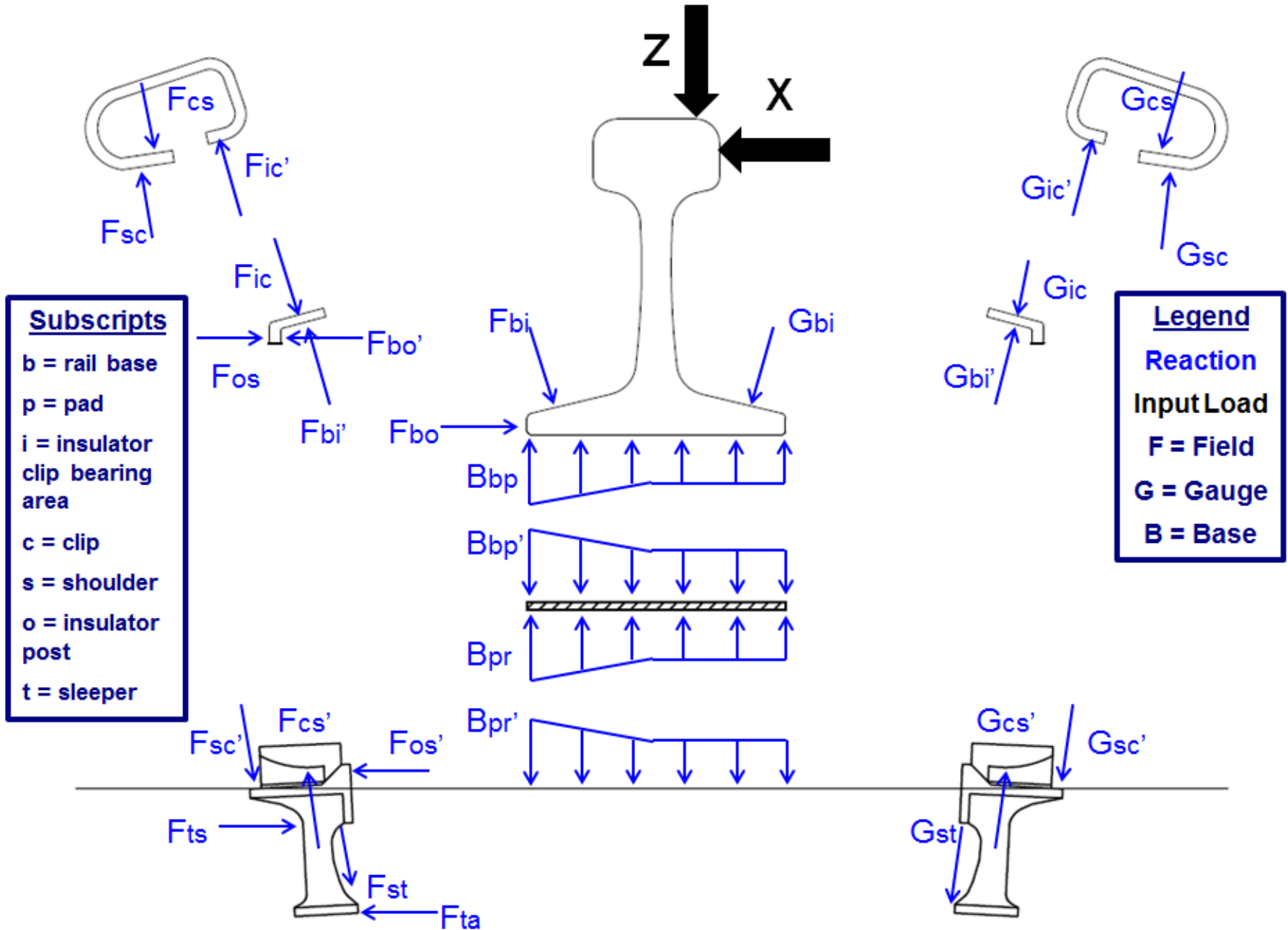

Rail Seat Load Calculation Methodologies

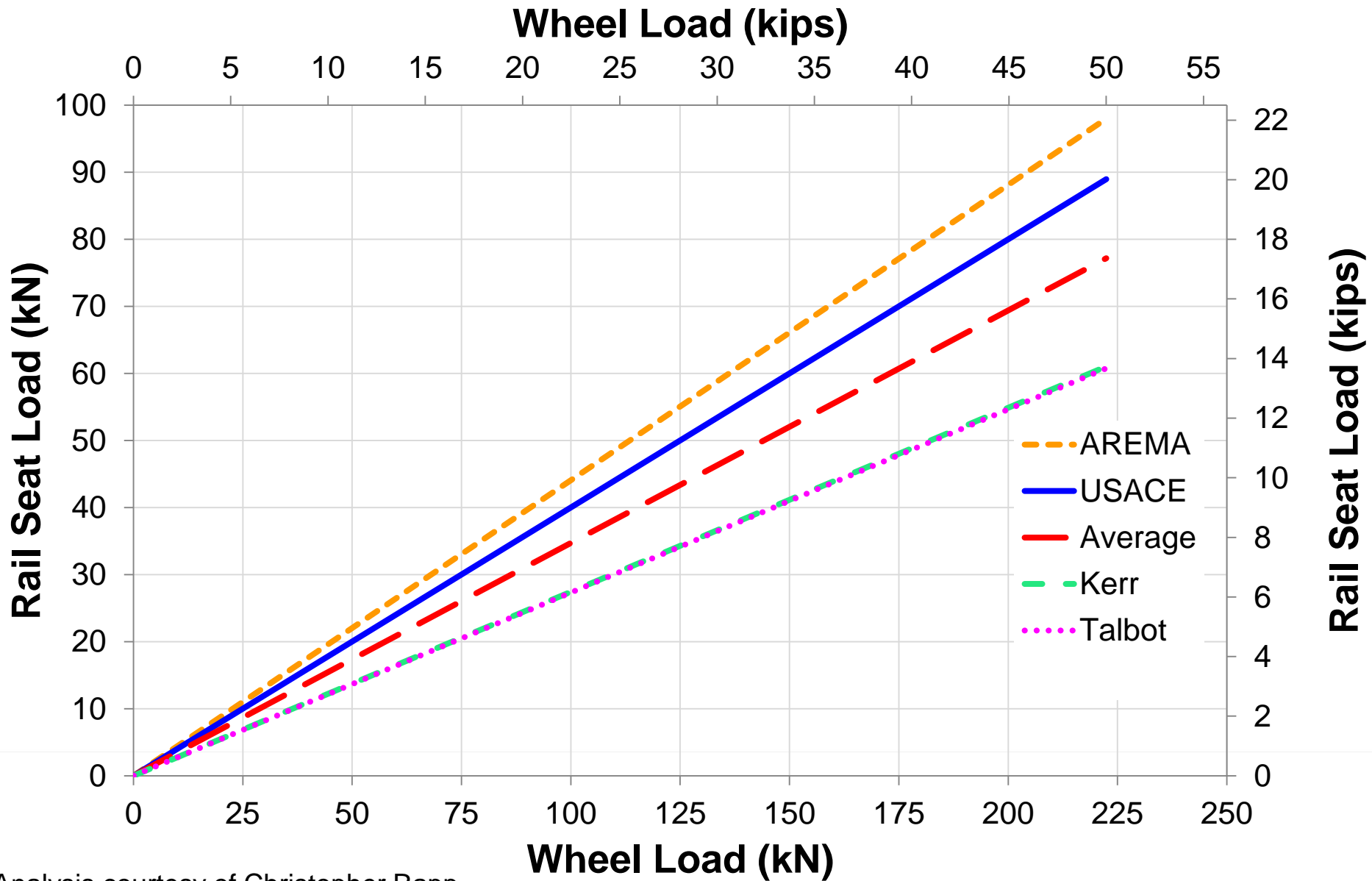

Outline

- Background and Research Justification
- RailTEC Concrete Crosstie Research
- Mechanistic Design Introduction
- Key Research Thrust Areas and Summary of Results
 - Laboratory Instrumentation
 - Field Instrumentation
 - Analytical Methods (FEA)
- Future Work
- Acknowledgements



FRA Tie and Fastening System BAA Objectives and Deliverables

- **Program Objectives**

- Conduct comprehensive international literature review and state-of-the-art assessment for design and performance
- Conduct experimental laboratory and field testing, leading to improved recommended practices for design
- Provide mechanistic design recommendations for concrete cross-ties and fastening system design in the US

- **Program Deliverables**

- Improved mechanistic design recommendations for concrete cross-ties and fastening systems in the US
- Improved safety due to increased strength of critical infrastructure components
- Centralized knowledge and document depository for concrete cross-ties and fastening systems



U.S. Department of Transportation
Federal Railroad Administration

FRA Tie and Fastener BAA
Industry Partners:



BUILDING AMERICA®



Quantification of Lateral Loads Entering the Shoulder Face (Insert)

- Instrumented shoulder face insert
 - Original shoulder face is removed
 - Small beam insert replaces removed section
 - 4-point bending beam experiment
 - Beam strategy is a well-established, successful technology

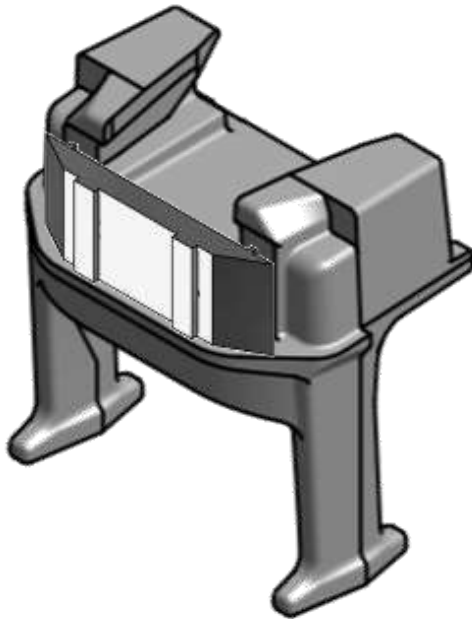

Transfer of Lateral Load to Shoulder Face

32.5 kip vertical load, 0.5 L/V ratio

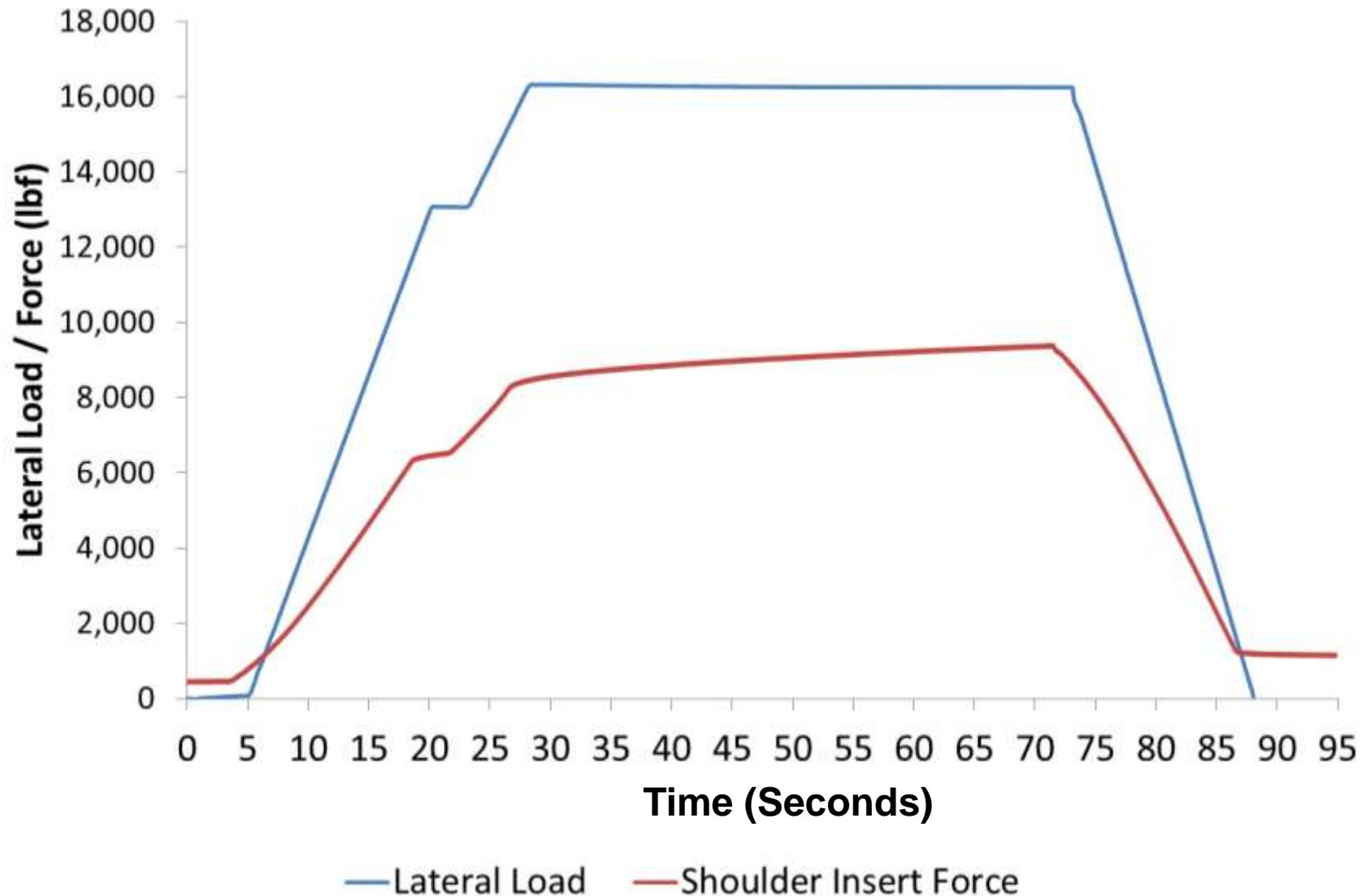

Percent of Lateral Load Transferred to Shoulder Preliminary Data

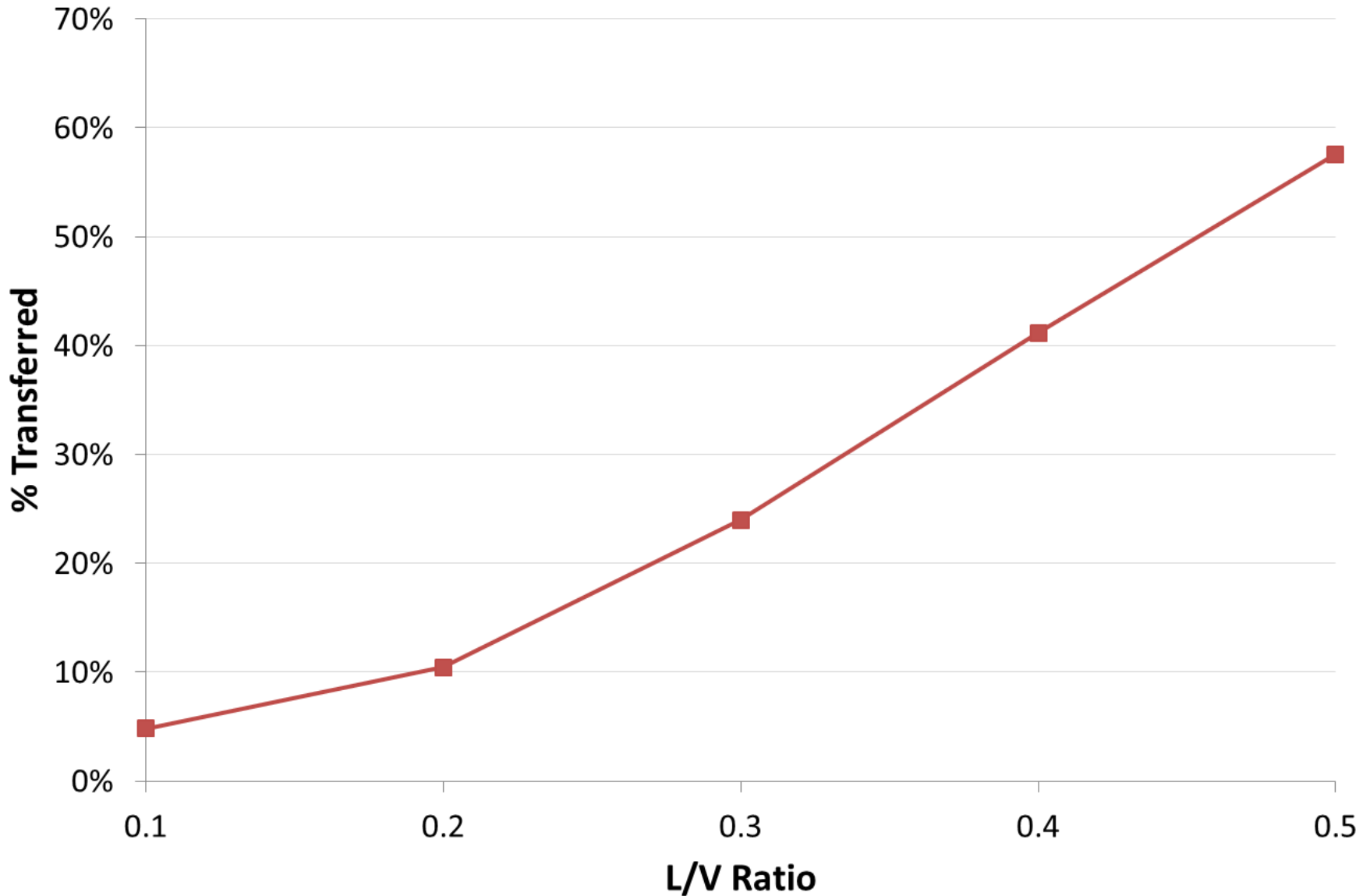

Full Scale Track Response Experimental System

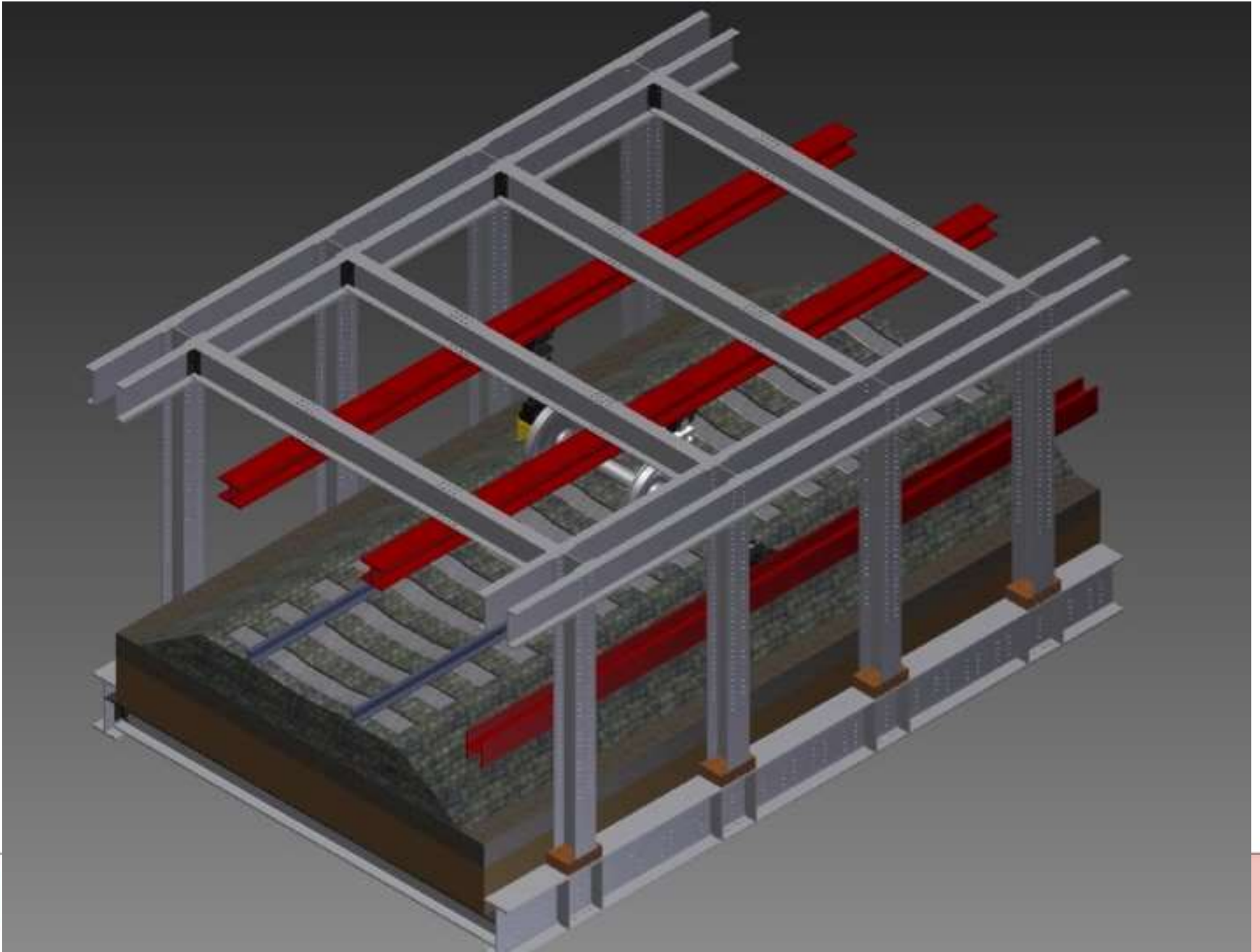

Full Scale Track Response Experimental System

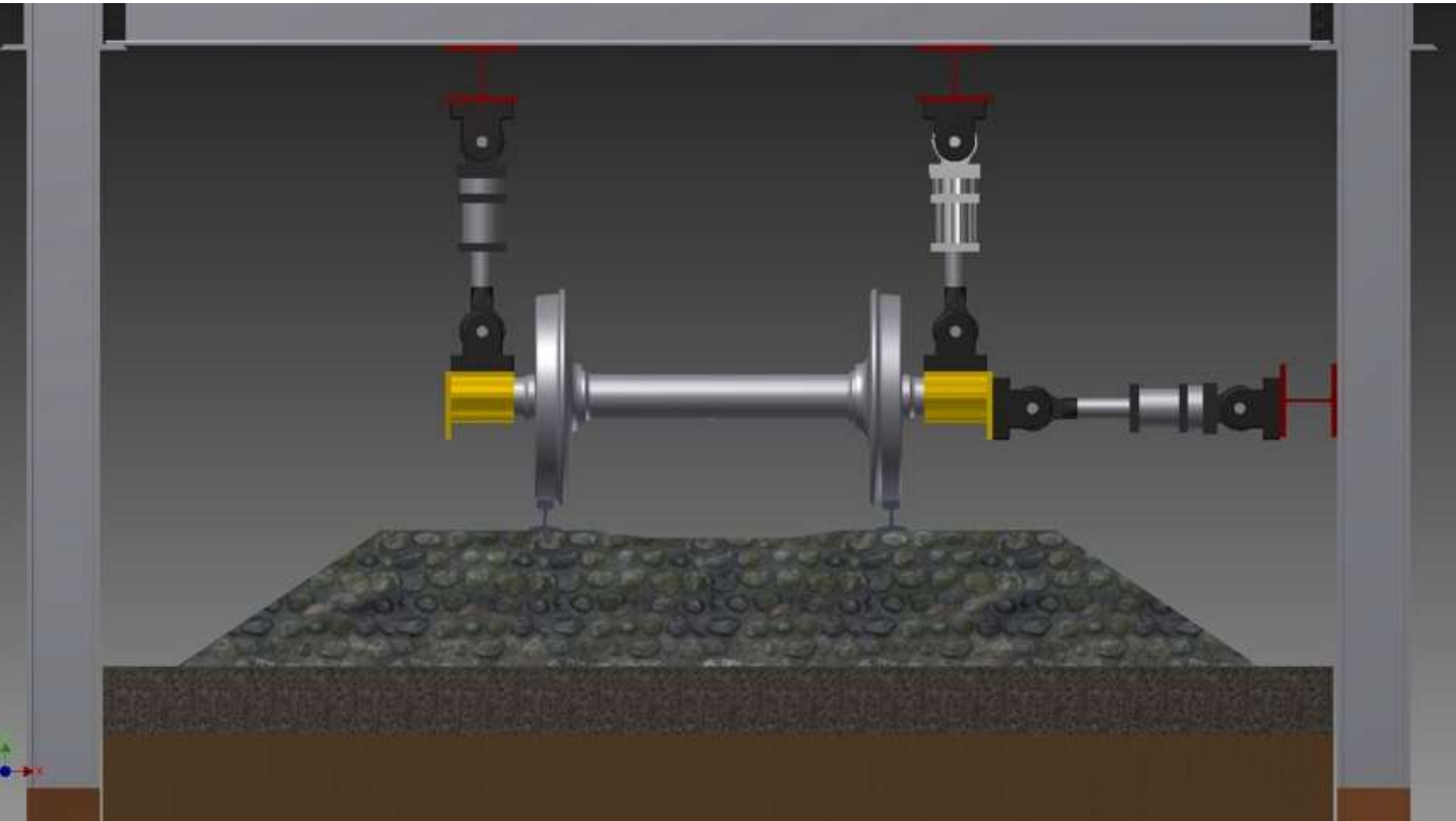

Outline

- Background and Research Justification
- RailTEC Concrete Crosstie Research
- Mechanistic Design Introduction
- Key Research Thrust Areas and Summary of Results
 - Laboratory Instrumentation
 - **Field Instrumentation**
 - Analytical Methods (FEA)
- Future Work
- Acknowledgements



Goals of Field Instrumentation

- Lay groundwork for mechanistic design of concrete crossties and elastic fasteners
- Quantify the demands placed on each component within the system
- Develop an understanding into field loading conditions
- Provide insight for future field testing
- Collect data to validate the UIUC concrete crosstie and fastening system FE model

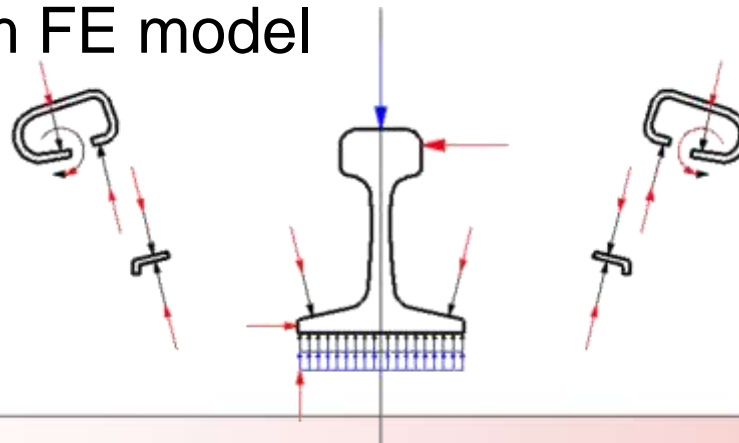

Areas of Investigation

Rail

- Stresses at rail seat
- Strains in the web
- Displacements of web/base

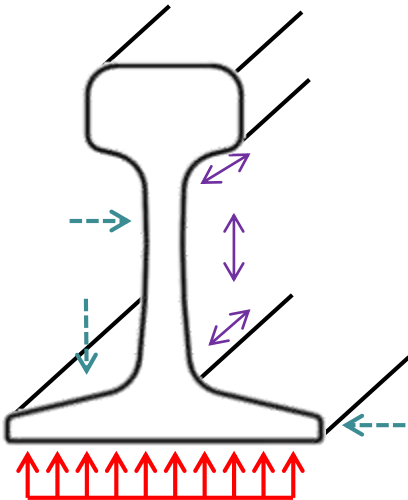

Fasteners/ Insulator

- Strain of fasteners
- Stresses on insulator



Concrete Crossties

- Moments at the rail seat
- Stresses at rail seat
- Vertical displacements of crossties

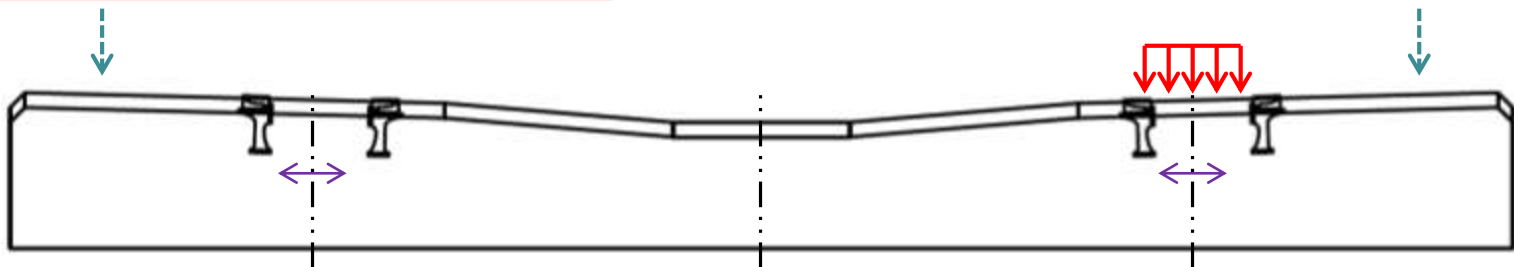

TTCI Field Testing Locations

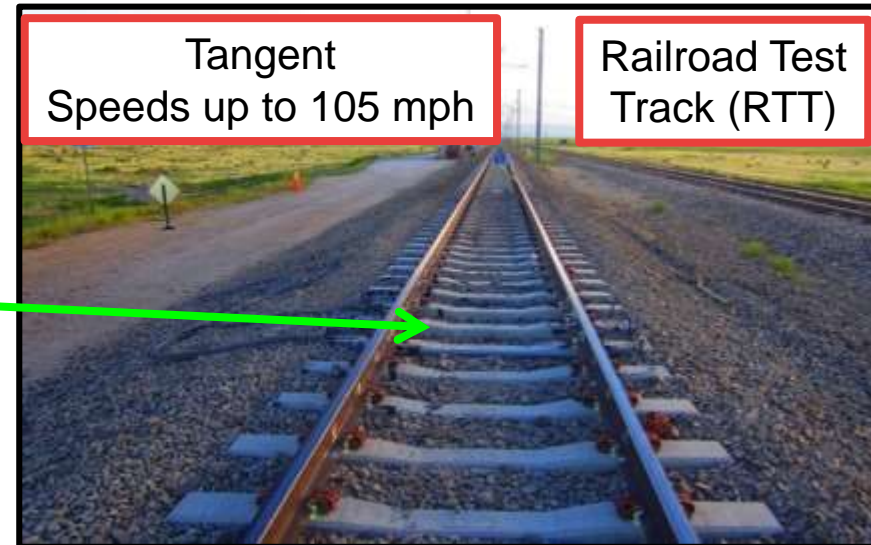
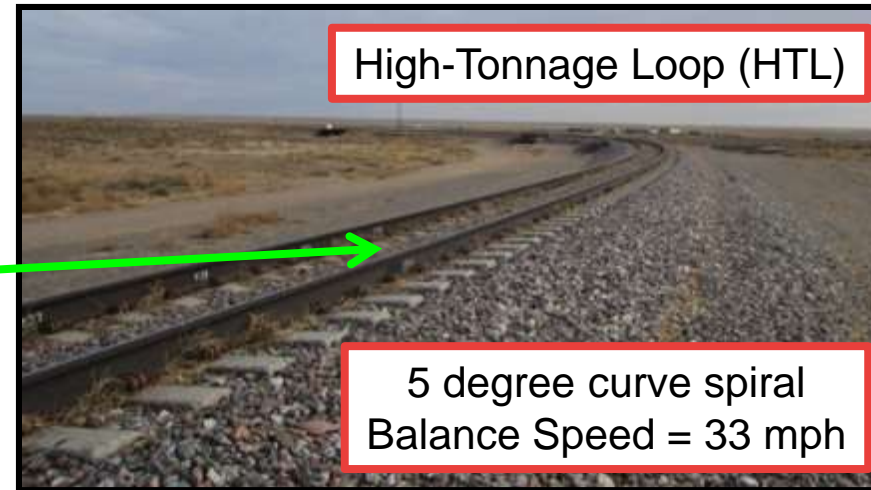
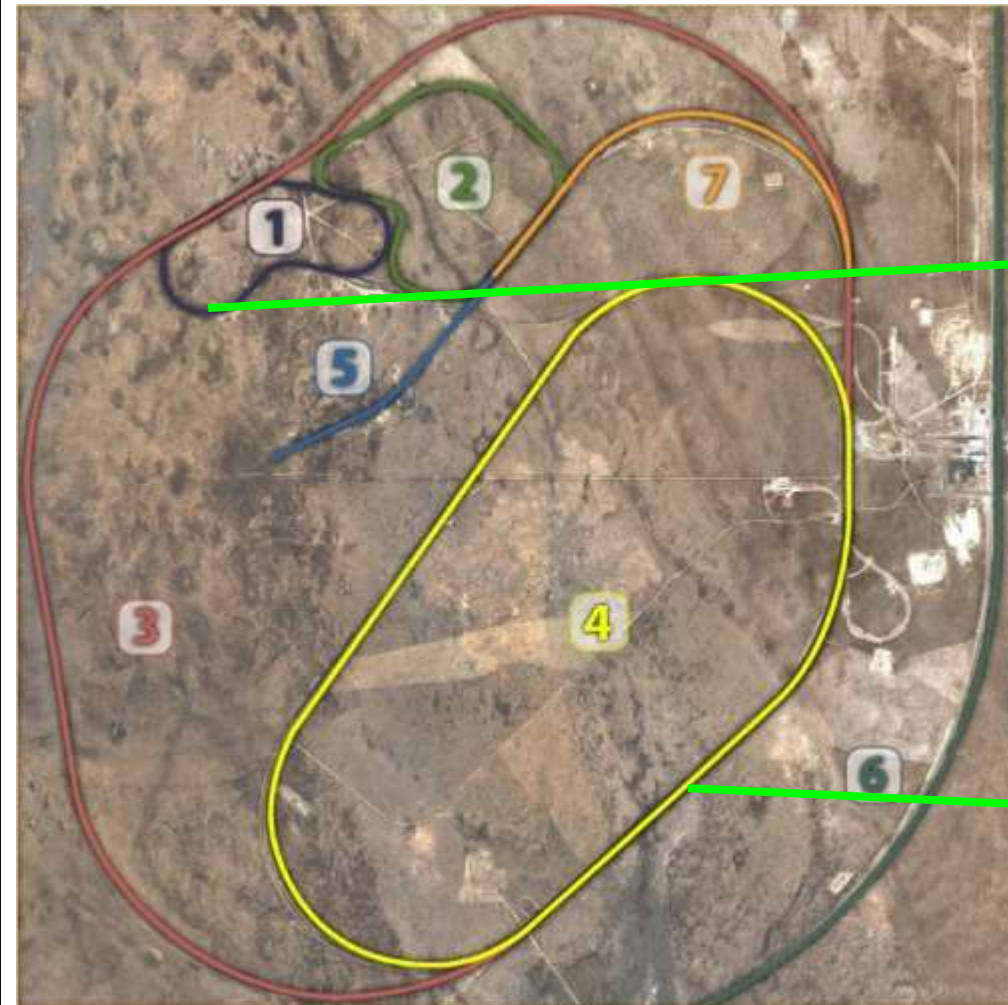

Loading Environment

- Track Loading Vehicle (TLV)
 - Static
 - Dynamic
 - Track modulus
- Freight Consist
 - 6-axle locomotive (393k)
 - Instrumented car
 - Nine cars
 - 263, 286, 315 GRL Cars
- Passenger Consist
 - 4-axle locomotive (255k)
 - Nine coaches
 - 87 GRL



Fully Instrumented Rail Seats

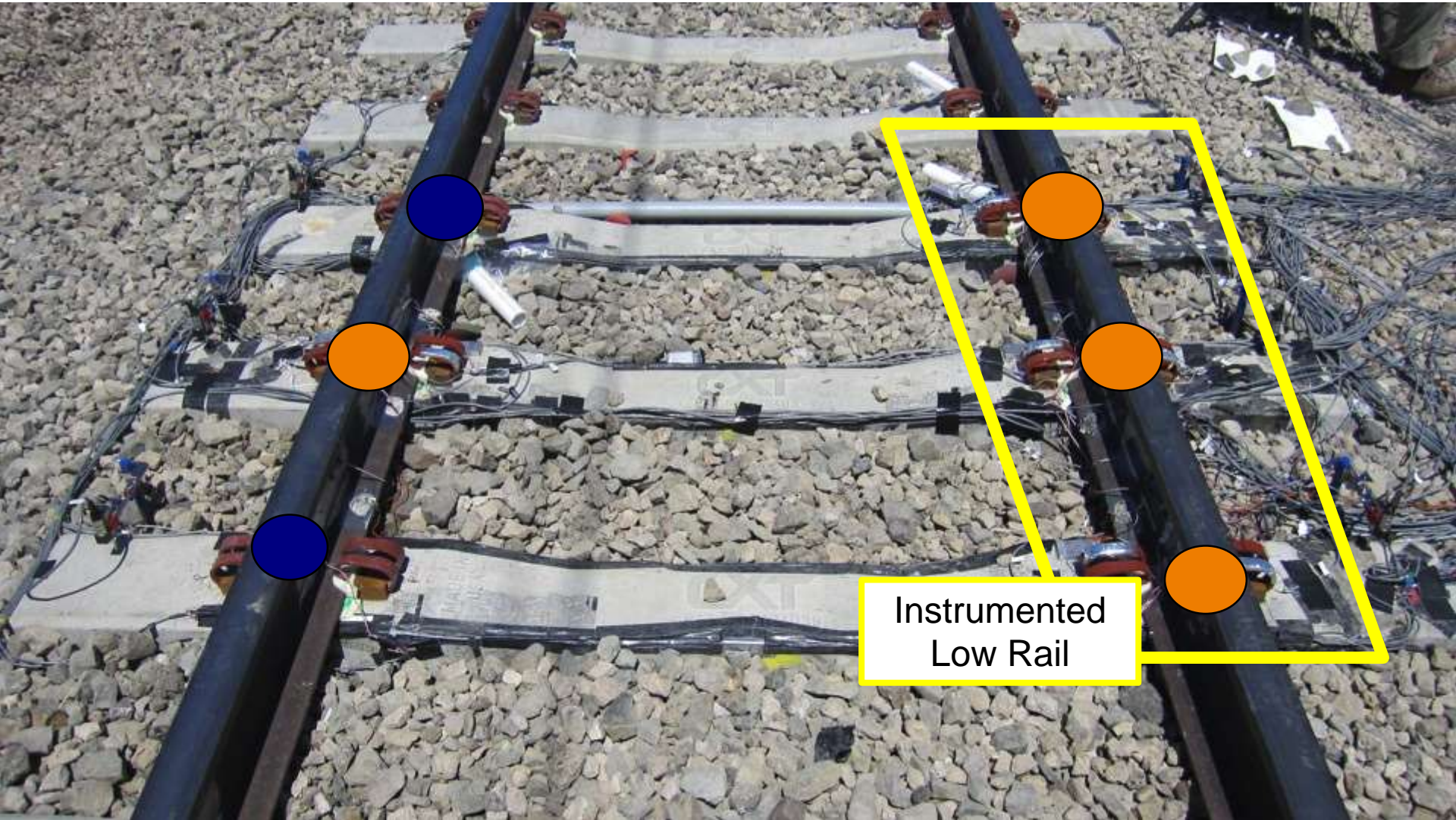

Instrumented Low Rail



Field-side Instrumentation

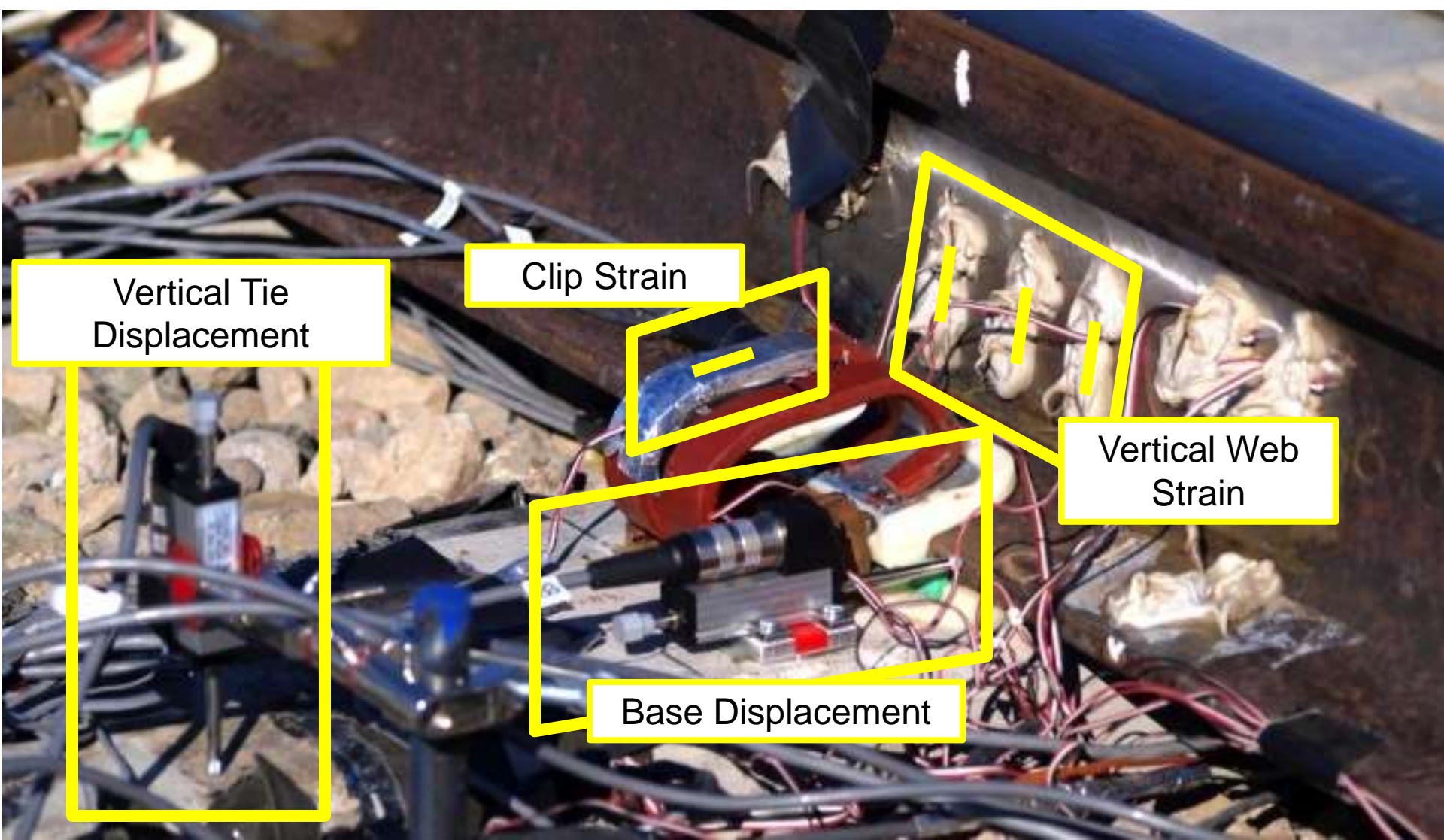

Gauge-side Instrumentation

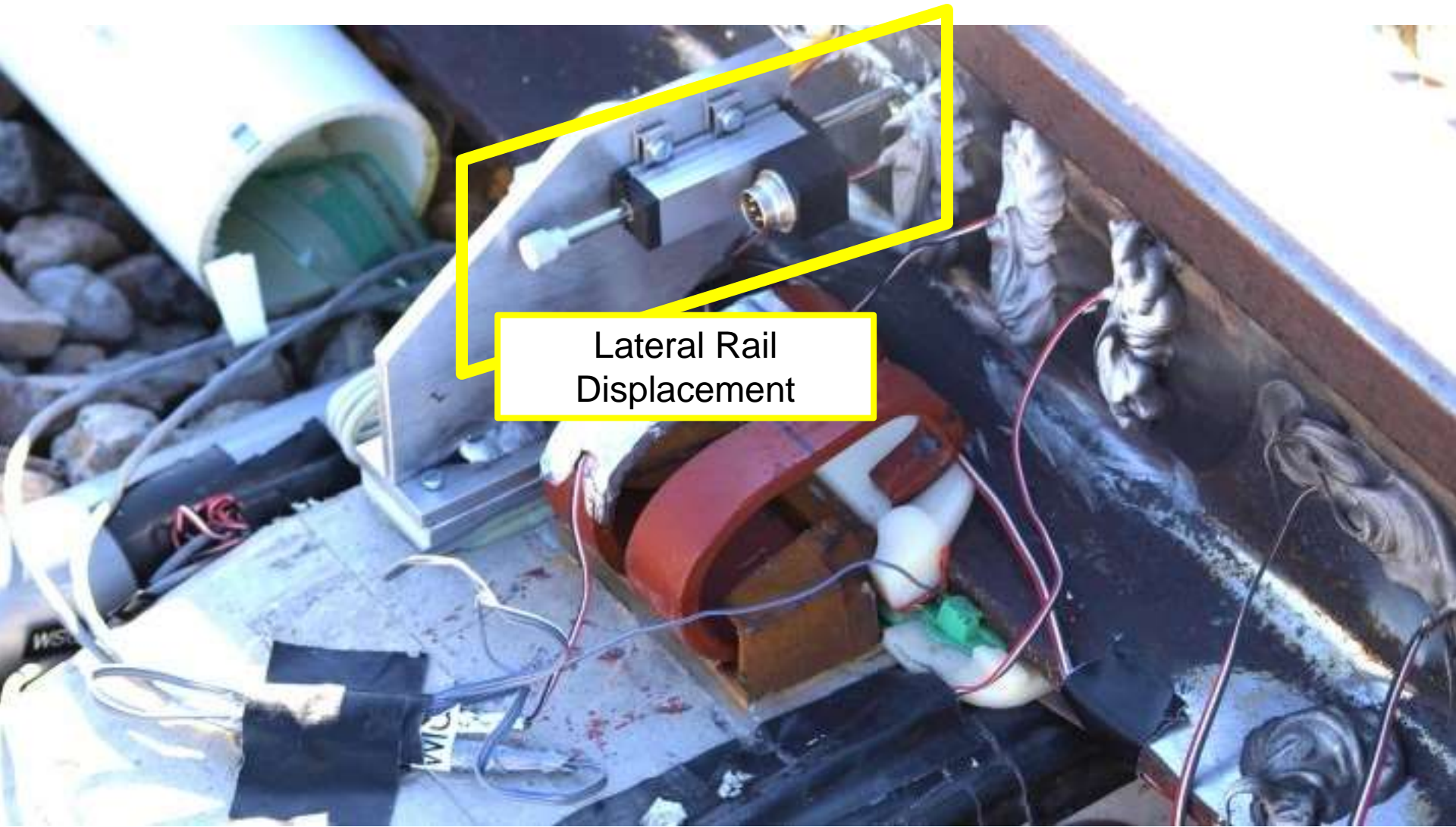

Data Acquisition System

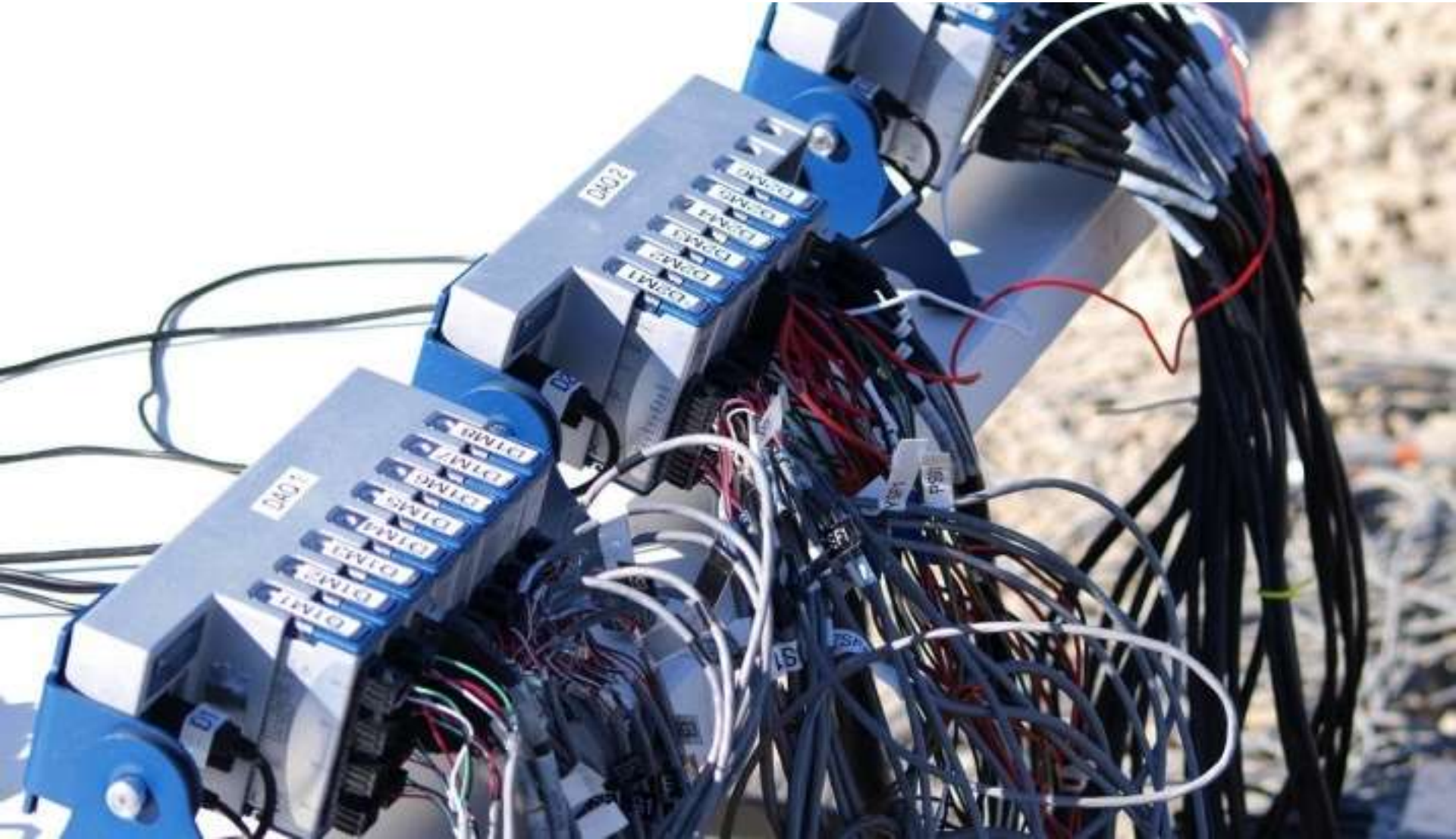

Tangent Track (RTT) – Passenger Train



Lateral Loads on Tangent Track (Freight)

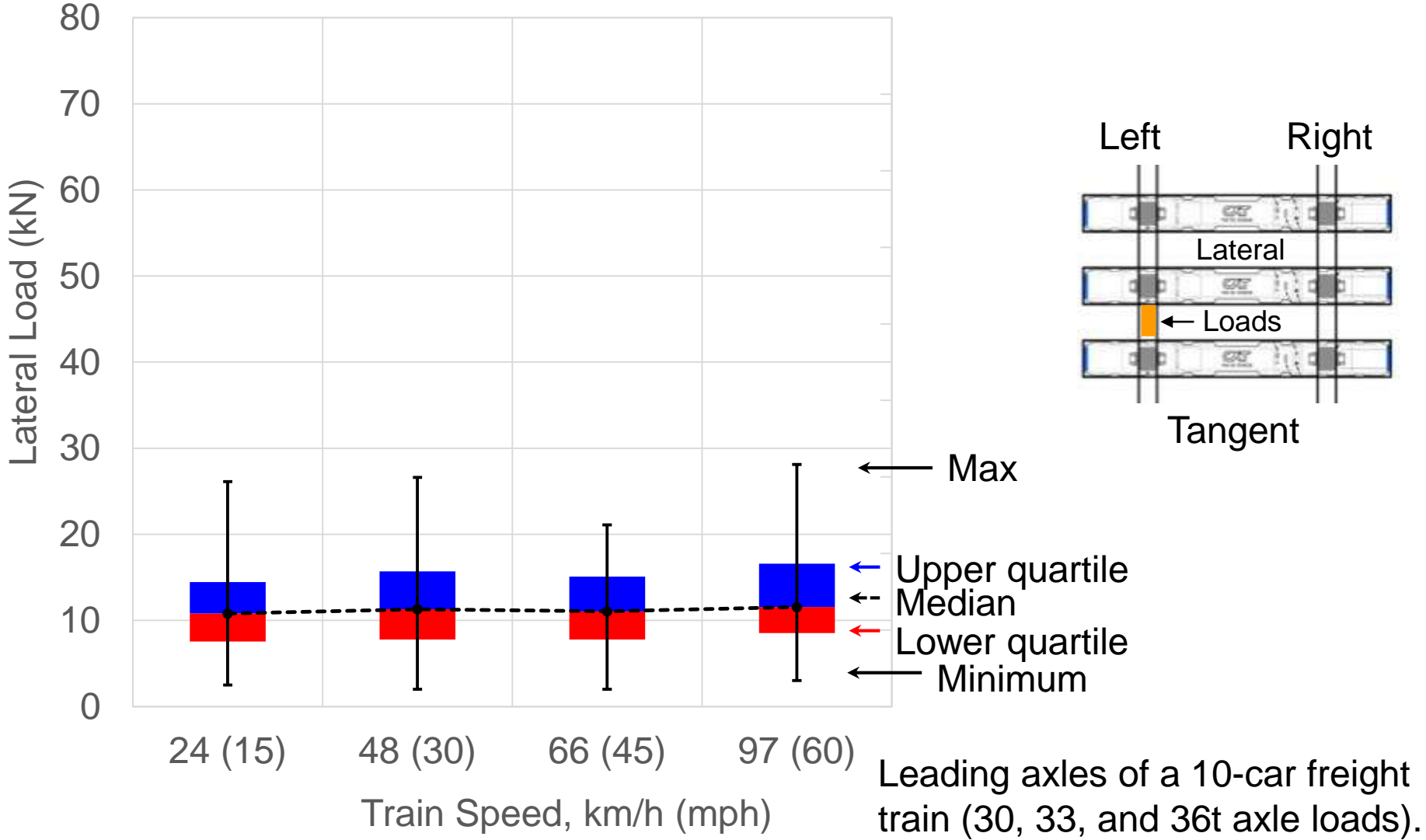

Leading axles of a 10-car freight train (30, 33, and 36t axle loads).



Lateral Loads on Tangent Track (Freight)

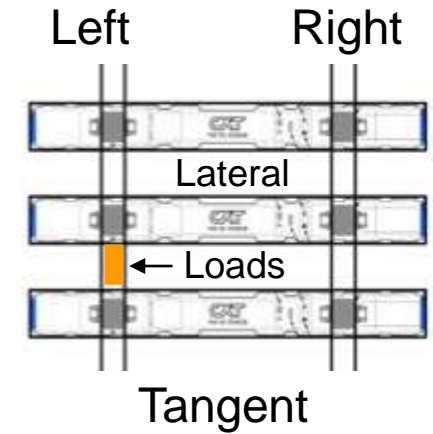
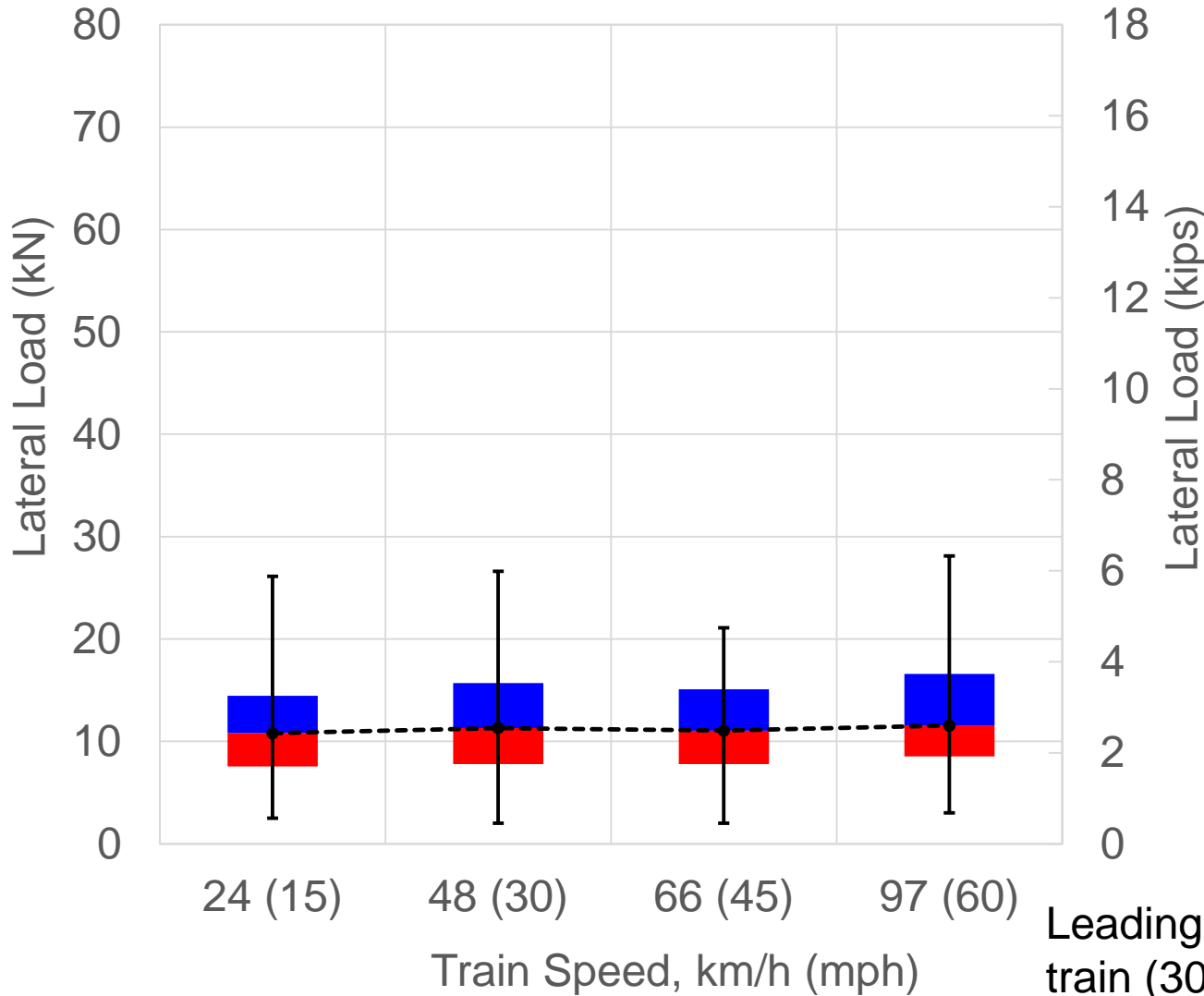

- No correlation between lateral loads and train speed on tangent track.

Leading axles of a 10-car freight train (30, 33, and 36t axle loads).



RTT Curved Instrumentation – Train Pass



Lateral Loads Acting on a Curve Track

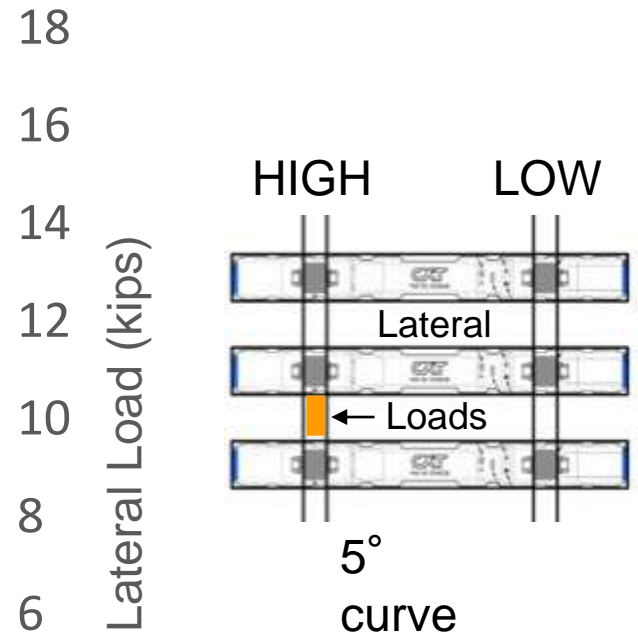
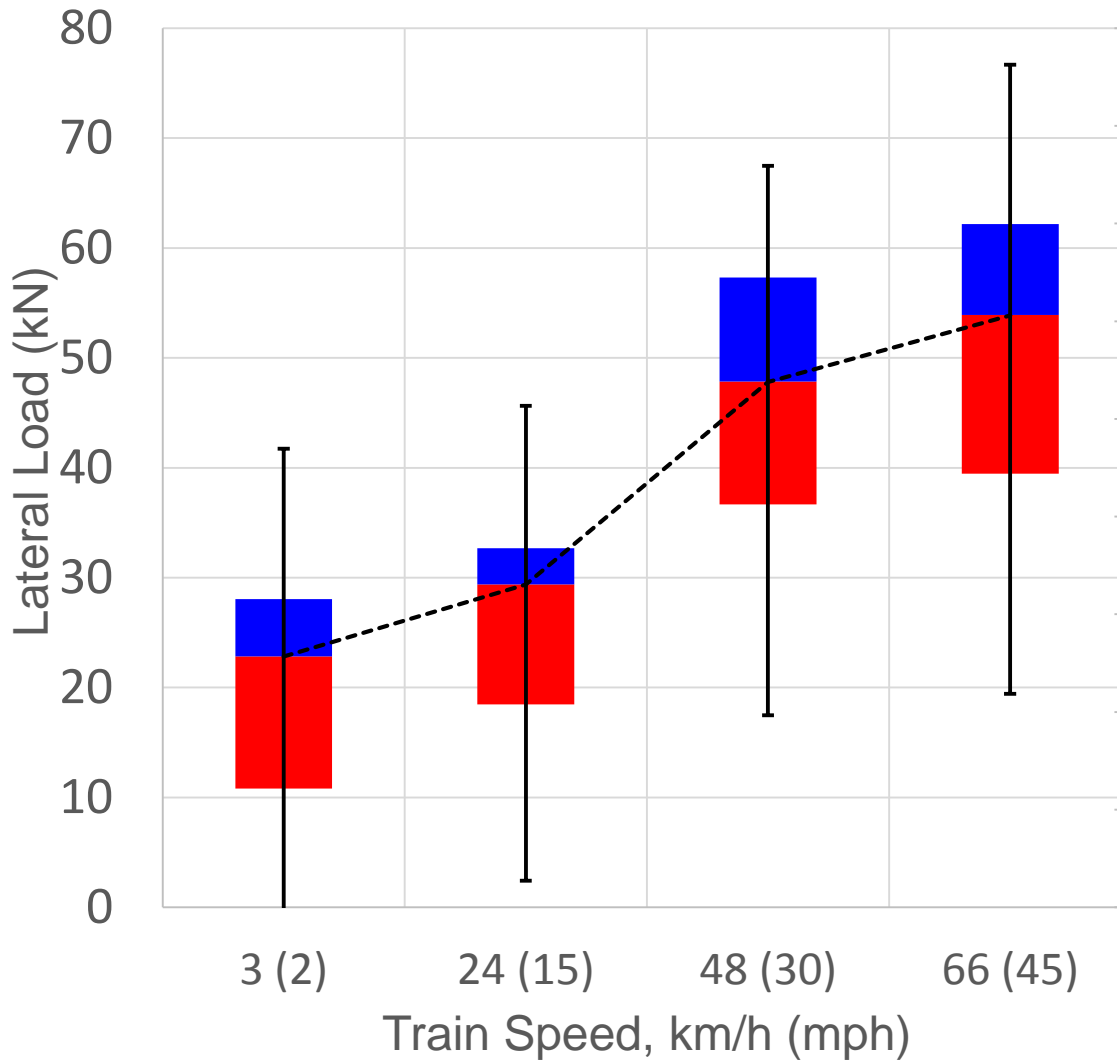

- Median load is ~5.5 times larger than what was recorded in tangent track.

Leading axles of a 10-car freight train (30, 33, and 36t axle loads).



Global Track Deflections Under Passage of Freight Train



Vertical Displacements of Crossties (HTL)

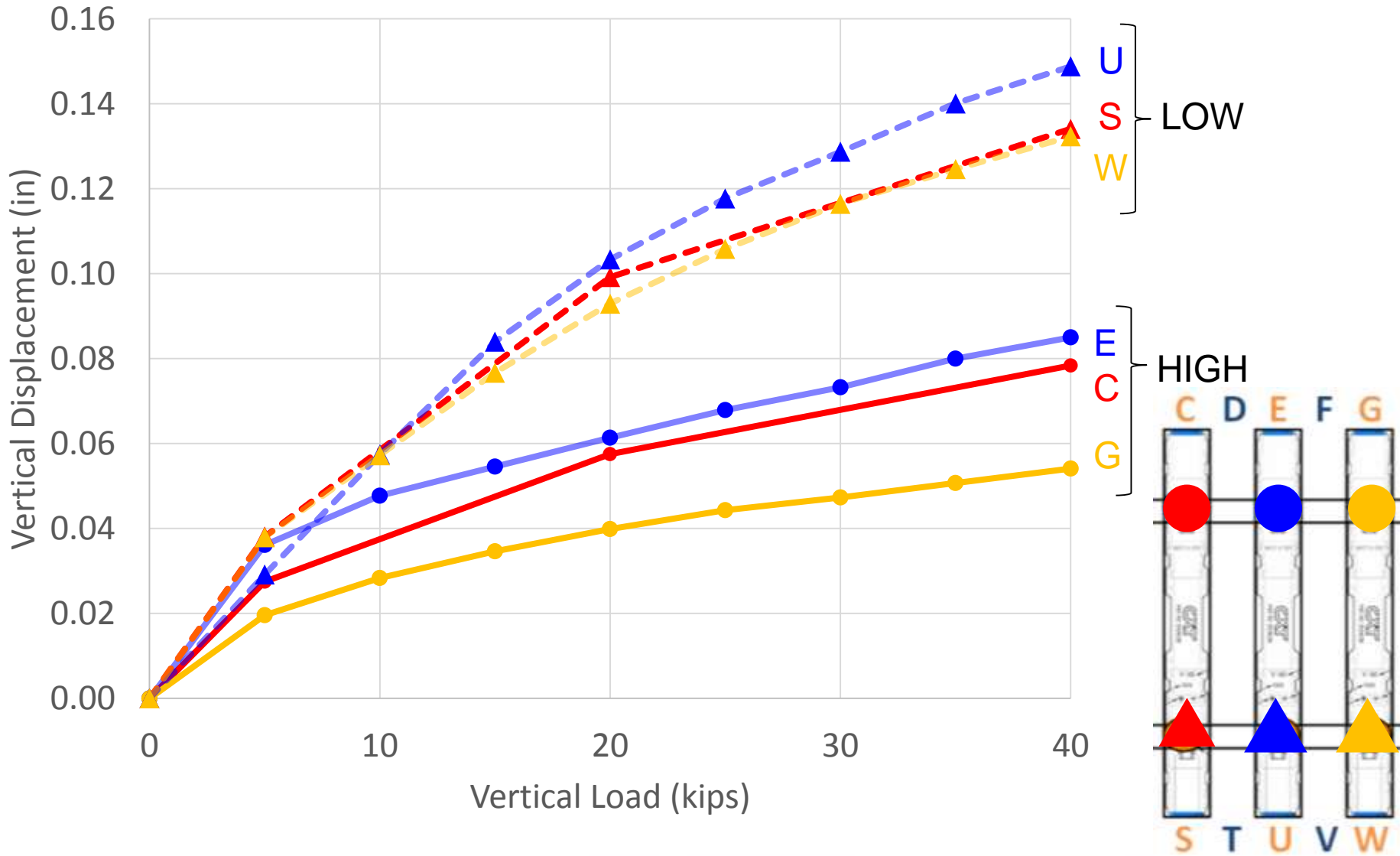

Effect of Train Speed on Tie Deflection

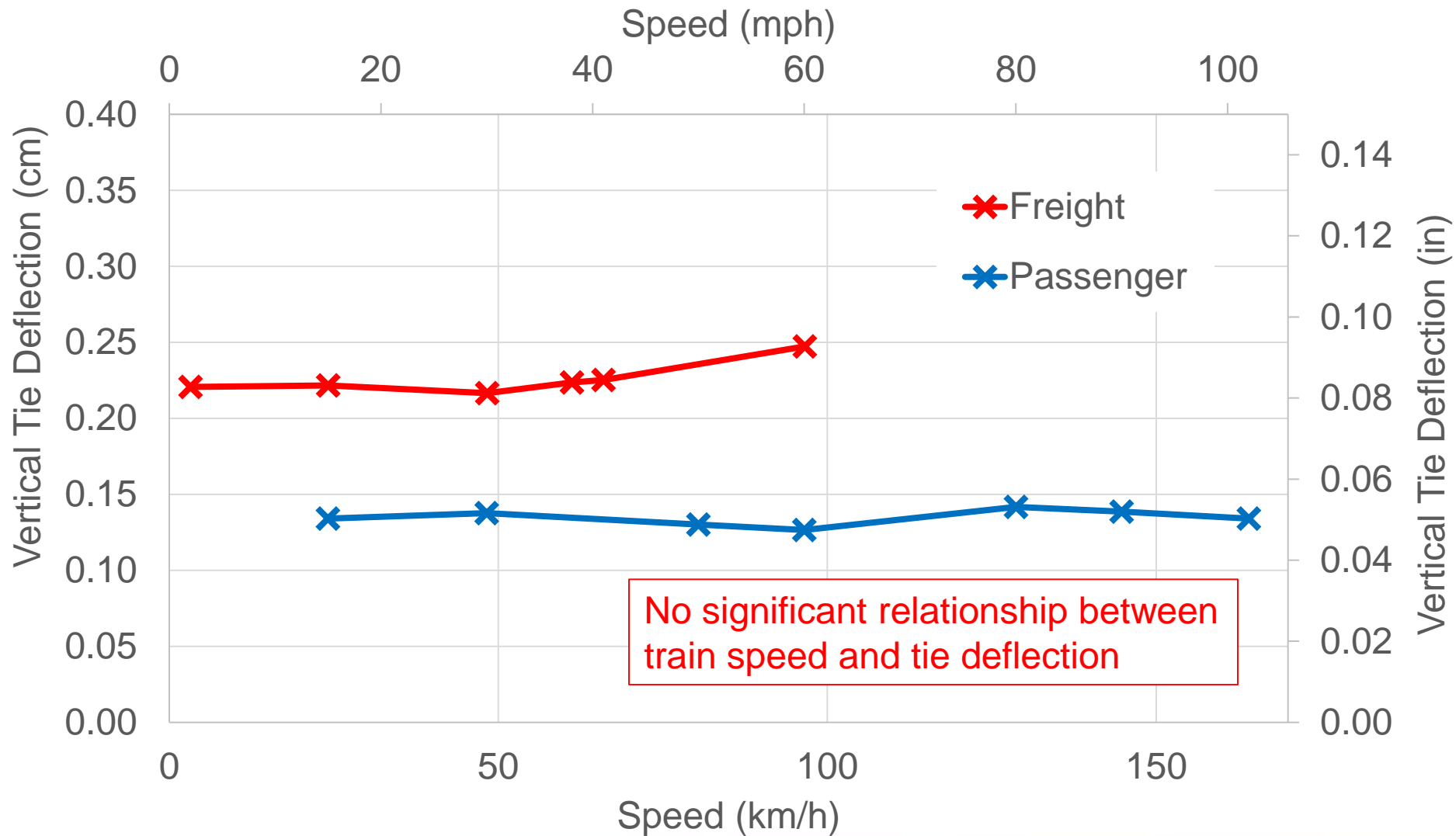

Effect of Load on Tie Deflection

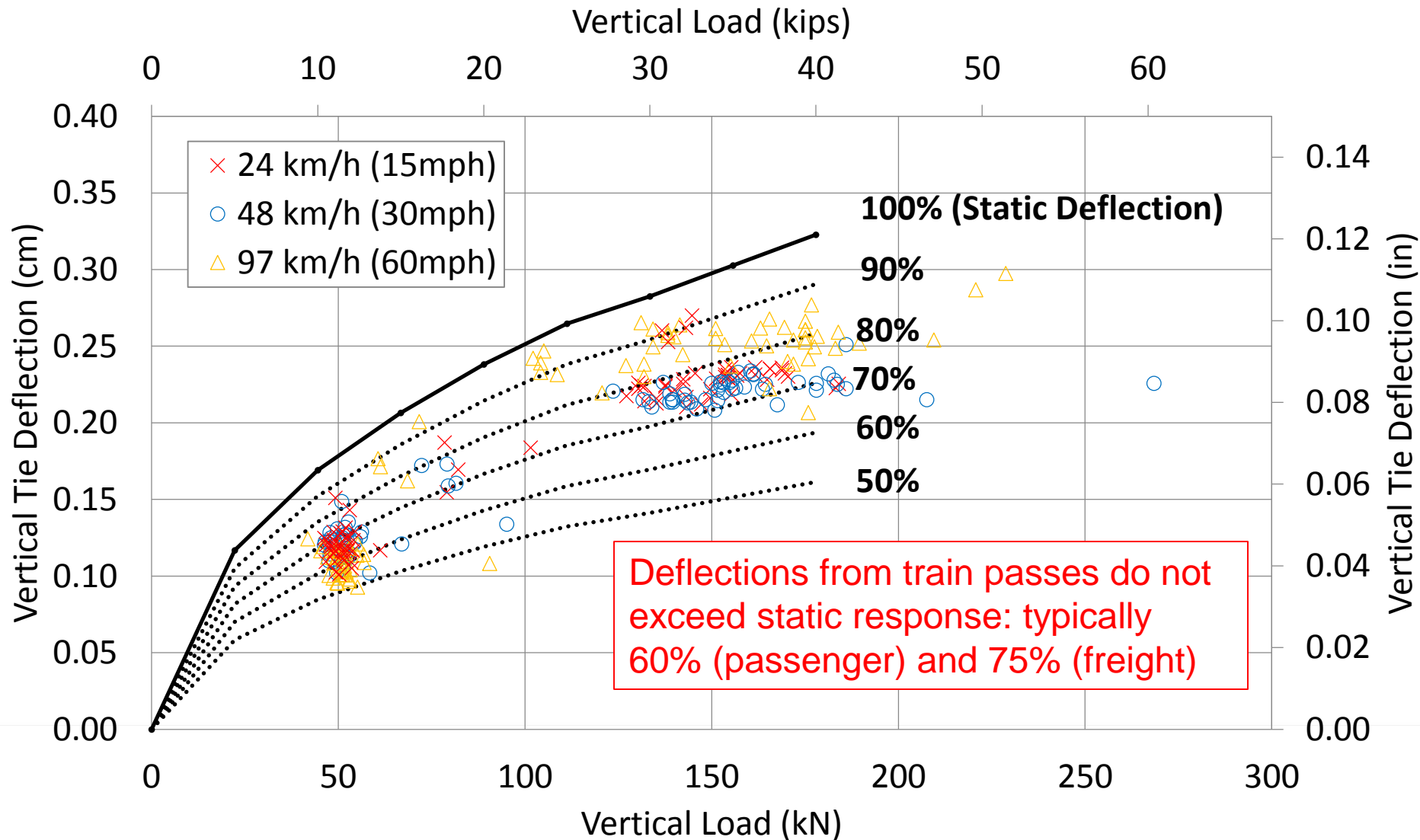

Outline

- Background and Research Justification
- RailTEC Concrete Crosstie Research
- Mechanistic Design Introduction
- Key Research Thrust Areas and Summary of Results
 - Laboratory Instrumentation
 - Field Instrumentation
 - **Analytical Methods (FEA)**
- Future Work
- Acknowledgements



Concrete Crosstie and Fastening System

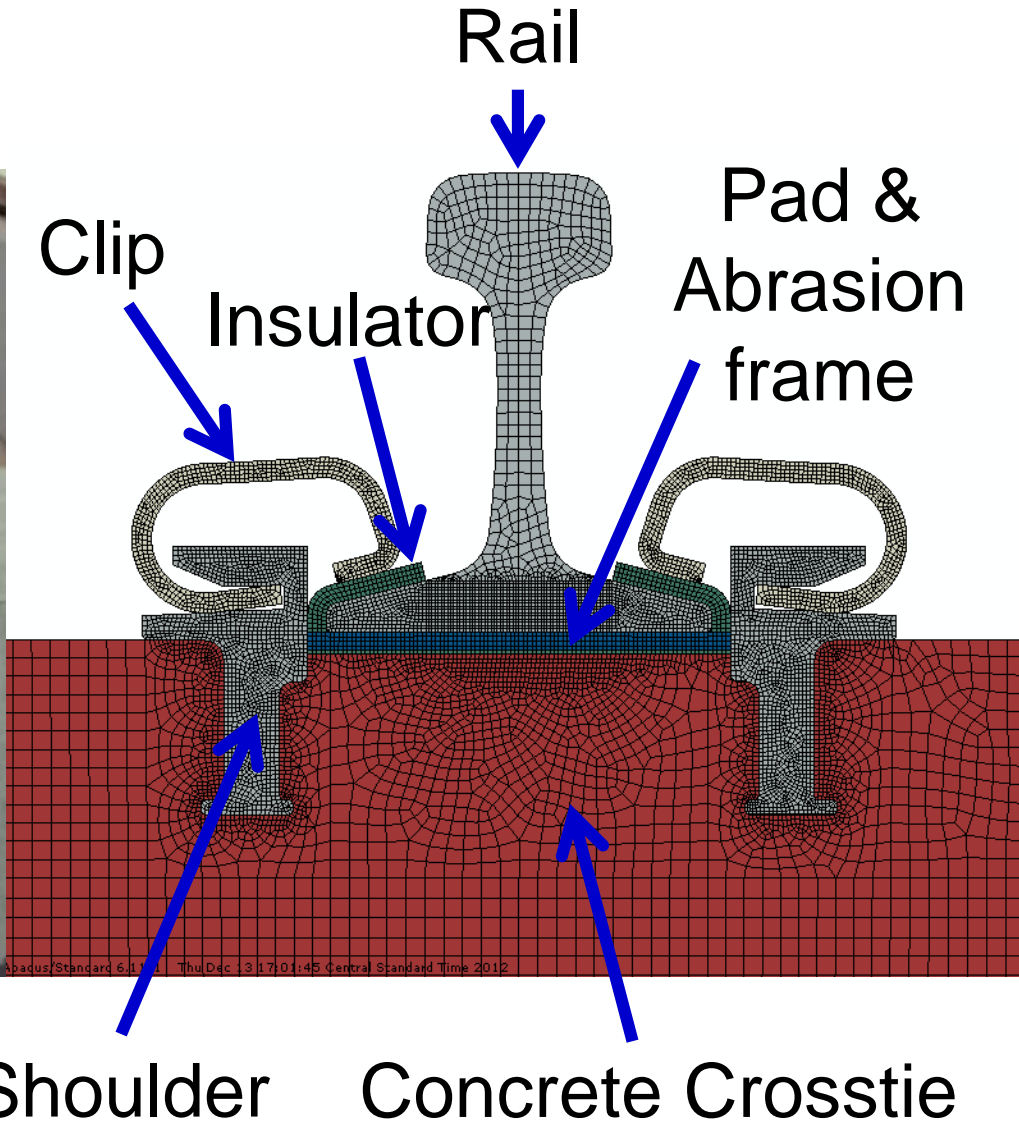

Apacus/Standard 6.1.1 Thu Dec 3 17:01:45 Central Standard Time 2012

Component Modeling: Validation

- Clip Model

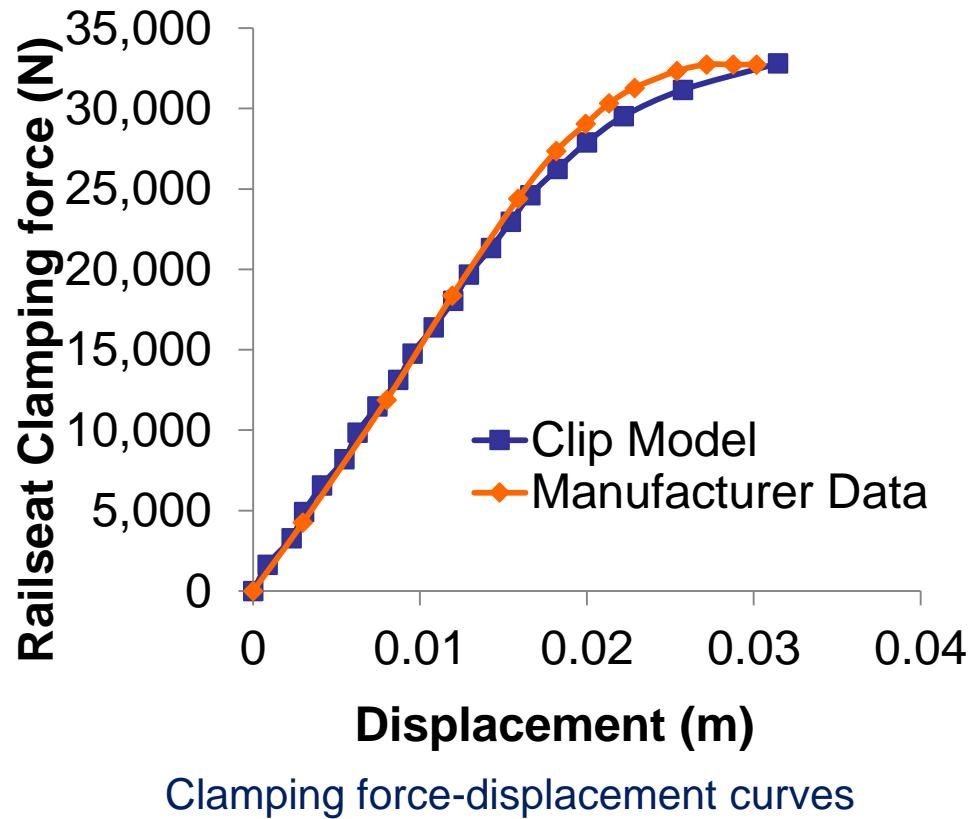
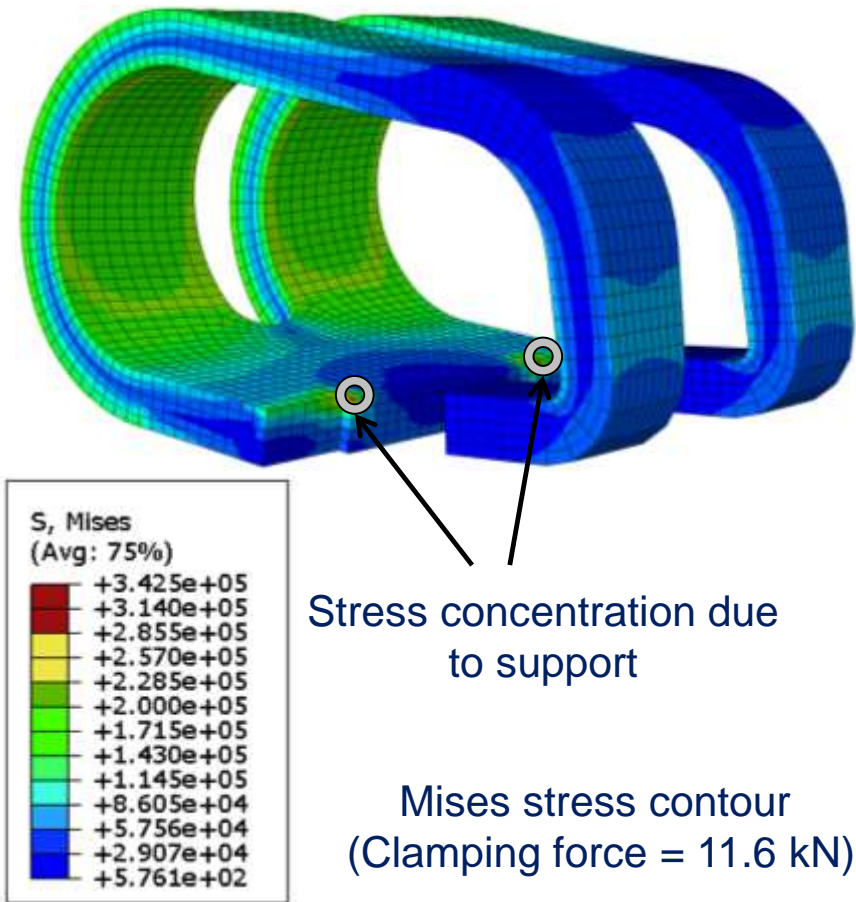

Component Modeling: Concrete Crosstie and Ballast



Static loading of the model

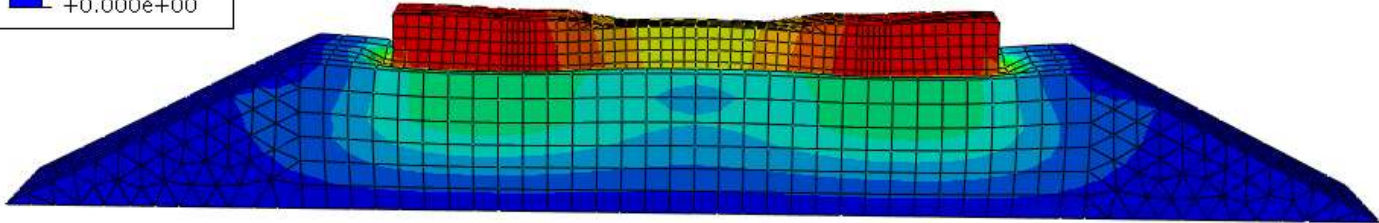
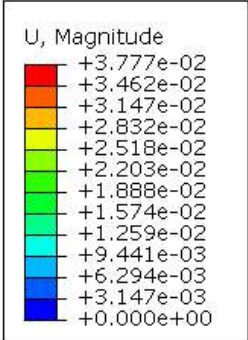

Deformation contour



System Model: Multiple-Tie Modeling

- Track loading vehicle (TLV) applying vertical and lateral loads to the track structure in field
- The symmetric model including 5 cross-ties

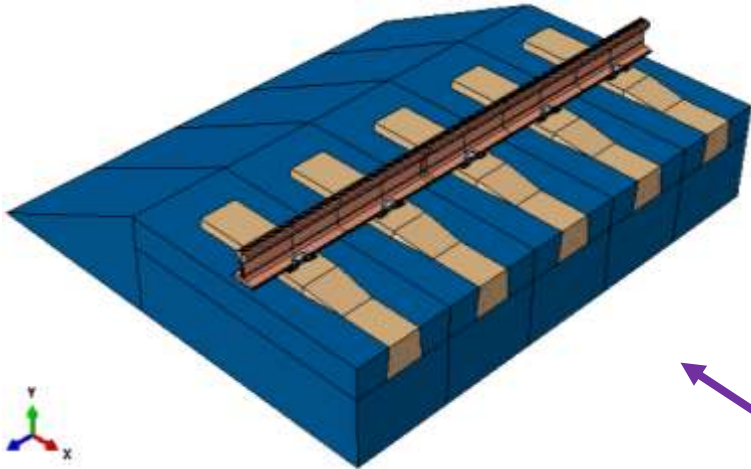

Simplified model:
Fastening system were replaced
by BCs and pressure

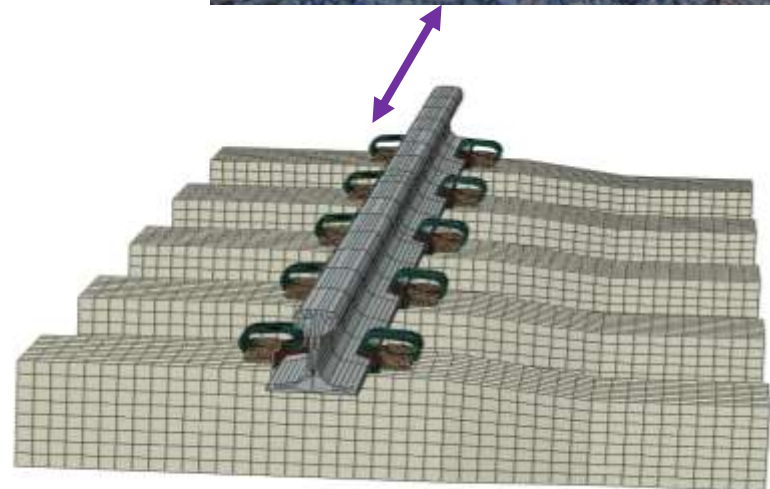

Detailed model with the fastening system

System Modeling: Lateral Load Path

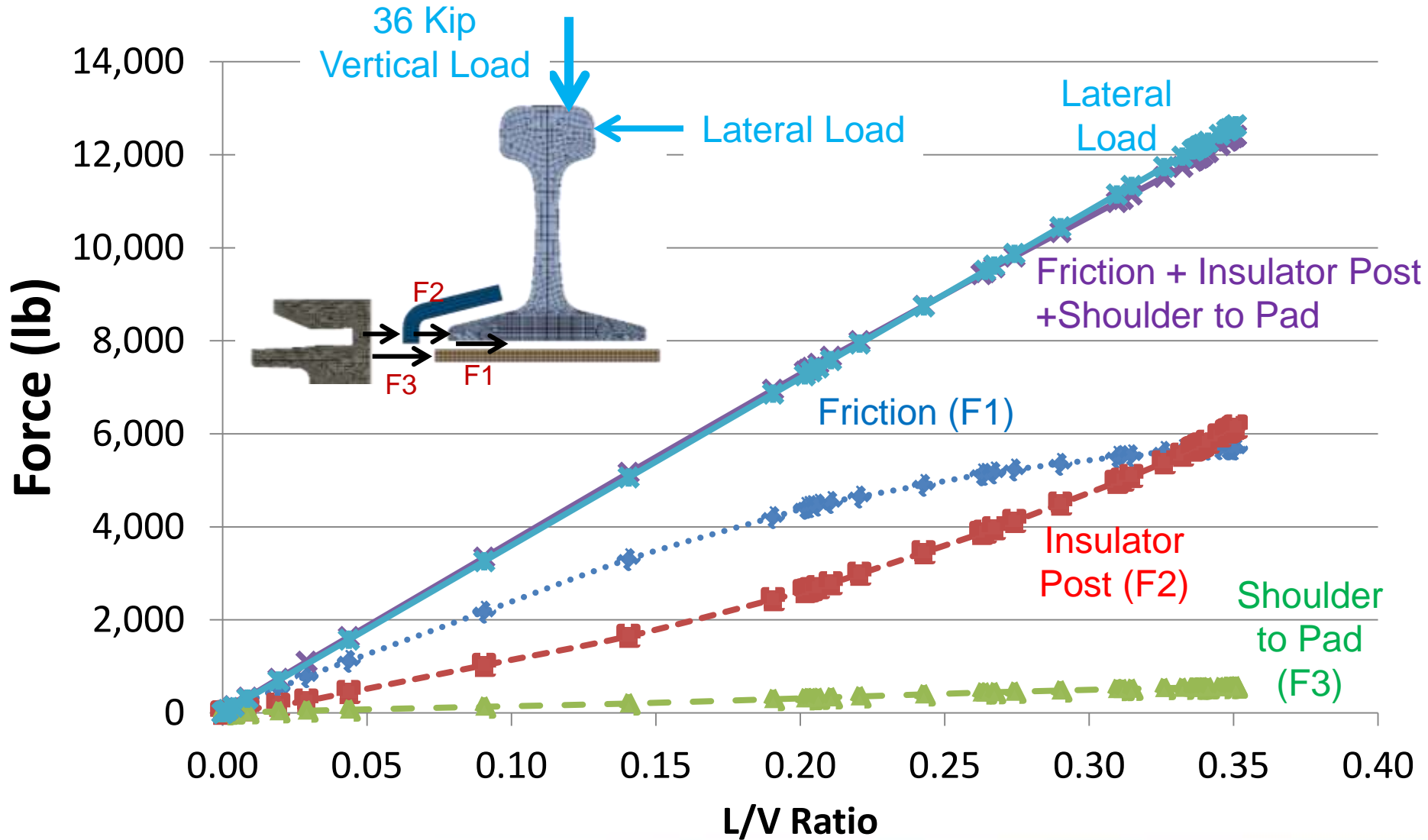

Outline

- Background and Research Justification
- RailTEC Concrete Crosstie Research
- Mechanistic Design Introduction
- Key Research Thrust Areas and Summary of Results
 - Laboratory Instrumentation
 - Field Instrumentation
 - Analytical Methods (FEA)
- Future Work
- Acknowledgements



Current Research Thrust Areas

- Continued **data analysis** to understand the governing mechanics of the system by investigating the:
 - elastic fastener (clamp) strain response
 - number of ties effected simultaneously
 - bending modes of the crossties
 - pressure magnitude and distribution at the rail seat
- Continued **comparison and validation** of the UIUC tie and fastening system finite element model (Chen, Shin)
- Preparation for **instrumentation trip** (May 2013)
 - Focus on lateral load path by gathering
 - relative lateral tie displacements
 - global lateral tie displacements
 - load transferred to the clip, insulator-post, and shoulder
- Small-scale, **evaluative tests** on Class I Railroads



RailTEC Concrete Tie Research Team



Acknowledgements

Research Sponsors:



U.S. Department of Transportation
Federal Railroad Administration



FRA Tie and Fastener BAA Industry Partners:



BUILDING AMERICA®



Other Supporting Organizations



BUILDING AMERICA®



CANADIAN
PACIFIC
RAILWAY



U.S. Department of Transportation
Federal Railroad Administration





Questions?

Riley Edwards

Senior Lecturer

Department of Civil and
Environmental Engineering

University of Illinois, Urbana-Champaign

Email: jedward2@illinois.edu

Brandon Van Dyk

Graduate Research Assistant

Department of Civil and
Environmental Engineering

University of Illinois, Urbana-Champaign

Email: vandyk2@illinois.edu