

Characterization of Ballast Performance in Heavy Axle Loading (HAL)

Eric Gehringer, Director of Standards & Technology, Union Pacific Railroad

David Read, Principal Investigator, and Dingqing Li, Scientist, TTCI

Erol Tutumluer, Professor Civil and Environmental Engineering, University of Illinois at Urbana-Champaign

**Abstract**

This paper will present results to date on a number of track research projects being conducted by Union Pacific Railroad in area of ballast.

**Introduction**

Ballast is a selected crushed and graded aggregate material which is placed upon the railroad roadbed for the purpose of providing drainage, stability, flexibility, uniform support for the rail and ties and distribution of the track loadings to the subgrade and facilitating maintenance.

There are distinct differences in the mineral composition of the various aggregate materials used for roadway ballast applications and the respective in track performance of those materials. Likewise, many variations exist in the mineral properties of aggregate materials within the same general nomenclature of the aggregates known as granites, traprocks, quartzites, dolomites, and limestones. One particular aggregate material may possess most of the desirable characteristics for a good ballast material while a deposit of apparently similar material located in the same general geographical area will not meet the applicable specification requirements for railroad ballast.

A variety of materials may be processed into railroad ballast. The following general classifications list the most common materials:

- Granite - is a plutonic rock having an even texture and consisting chiefly of feldspar and quartz. Plutonic rock is rock formed at considerable depth by chemical alteration. It is characteristically medium to coarse grained, or granitoid texture.

- Traprock - is any dark-colored fine grained non-granitic hypabyssal or extrusive rock. Hypabyssal rock pertains to igneous intrusion or to the rock of that intrusion whose depth is intermediate between that of plutonic and the surface.
- Quartzite - is a granoblastic metamorphic rock consisting mainly of quartz and formed by recrystallization of sandstone or chert by either regional or thermal metamorphism. Quartzite may also be a very hard, but unmetamorphosed sandstone, consisting chiefly of quartz grains with secondary silica that the rock breaks across or through the grains rather than around them.
- Chert- is a hard, dense cryptocrystalline sedimentary rock consisting dominantly of interlocking crystals of quartz.
- Carbonate – is a sedimentary rock consisting primarily of carbonate materials such as limestone and dolomite.

Ideally processed ballast should be hard, dense, of an angular particle structure providing sharp corners and cubical fragments and free of deleterious materials. Ballast materials should provide high resistance to temperature changes, chemical attack, have high electrical resistance, low absorption properties and be free of cementing characteristics.

As ballast ages, it is progressively fouled with fine-grained materials filling the void spaces. There exist three major categories of ballast fouling that include: surface infiltration, mechanical breakdown of ballast and fouling from below the ballast.

Surface Infiltration

- Commodities from railcars (i.e. coal)
- Blowing dust and dirt
- Brake shoe dust

- Traction sand
- Diesel soot

#### Mechanical Breakdown

- Ballast to ballast interaction
- Maintenance operations (i.e. surfacing)
- Tie/ballast shearing
- Transportation/handling during shipment

#### Below the Ballast Fouling

- Infiltration of sub ballast and/or sub grade material

Primary objectives of Union Pacific Railroad ballast research include:

#### Ballast Supplier Wash Facilities

- Determine the amount of fines contained in the average ballast sample, which is representative of the fine production during manufacturing
- Evaluate the effectiveness of each supplier's wash facilities to remove fines
- Identify the most effective wash facility configurations for reducing ballast fines

#### Ballast Segregation During Unloading (belt train)

- Quantify the level of segregation that occurs during ballast unloading from belt train
- Evaluate the design of the new prototype for the boom
- Evaluate the effectiveness of the new prototype to eliminate segregation of ballast delivered via belt train

#### In-Track Ballast Box Research

- Measuring the rate of coal fine accumulation and the settlement behavior of the coal fines over time
- Measuring ballast degradation and track settlement of different ballast materials

- Measuring ballast pressures over time
- Establish ballast tiered standard
- Define optimum track surfacing intervention intervals

#### Ballast Supplier Wash Facilities

As of July 1, 2012 Union Pacific Railroad sources ballast from eleven different suppliers across the western United States. The ballast wash facilities of each vendor are unique to their operations with some utilizing spray bars, auger wash plants, etc. Union Pacific Railroad desired to understand the effectiveness of each wash facility and related protocol.

#### Primary Objectives

- Determine the amount of fines (<#200) contained in the average ballast sample, which is representative of the fine production during manufacturing.
- Evaluate the effectiveness of each supplier's wash facilities to remove fines.
- Identify the most effective wash facility configurations for reducing ballast fines.

Figure 1 contains the percent of fines contained in ballast sample obtained prior to washing. The Union Pacific Railroad mainline specification requires a maximum of 0.5% of fines (shown as red line in Figure 1). Based on the subject specification, the pre-wash condition of eight out of eleven supplier's products was non-compliant.

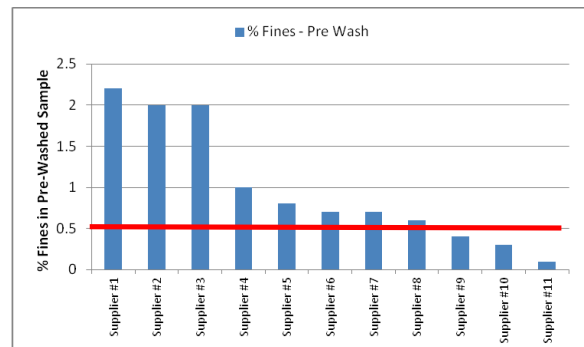

Figure 1 - % Fines – Pre Wash

Figure 2 contains the percent of fines prior to ballast being washed, percent fines after the ballast has been washed and the respective percent reduction in fine content.

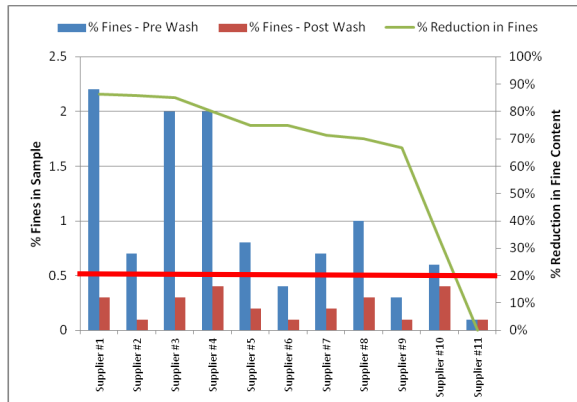

Figure 2 - % Reduction in Fines

The ideal wash plant effectiveness ratio, which constitutes the percent of fines removed, is greater than 70%. Attributes of the most effective wash facility configurations capable of achieving a 70% effectiveness ratio include:

- Minimum of three wash plant decks
- Minimum of five wash bars per deck
- Minimum twelve spray nozzles per wash bar

### Ballast Segregation During Unloading (belt train)

Union Pacific Railroad contracts multiple ballast belt trains annually. The subject equipment utilizes a system of conveyor belts to unload ballast at off track locations. The belt trains are typically used for stock piling ballast to support projects that include but are not limited to road crossing rehab, turnout undercutting and new construction, Figure 3.



Figure 3 – Belt Train

Ballast being delivered via the belt train conveyor system has a natural tendency to segregate due to the physics of momentum. Larger ballast with greater momentum due to increased mass will travel farther off the end of a delivery belt compared to smaller pieces of ballast. The subject phenomenon can be witnessed by a person who shoots a small caliber bullet versus a larger caliber bullet (assumes same charge size and angle relative to the earth) in which the larger bullet will carry further than the smaller bullet before impact.

In March 2011 Union Pacific Railroad personnel began collaborating with the belt train supplier to develop a prototype belt train boom attachment designed to reduce segregation.

### Primary objectives

- Quantify the level of segregation that occurs during ballast unloading from belt train.
- Evaluate the design of the new prototype for the boom.
- Evaluate the effectiveness of the new prototype to eliminate segregation of ballast delivered via belt train.

Segregation testing was performed using both mainline (type 1) and yard (type 2) ballast types. The subject testing was conducted near Kansas City, MO and Kearney, NE. The configuration of the test is shown in Figure 4.

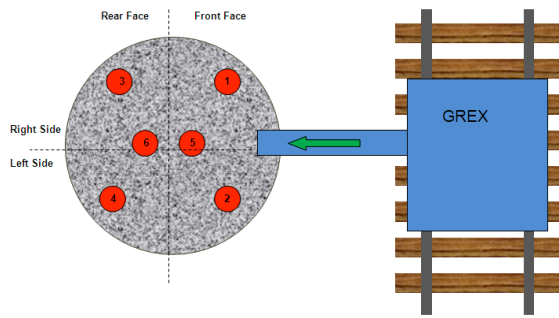

Figure 4 – Test Configuration

Samples taken from locations 1-6 in figure 4 were utilized to quantify the level of segregation (no prototype installed). Figure 5 provides the percent passing for each ballast grade for locations 5 and 6 as well as the percent difference as an example of the results. The data confirms that segregation does occur during unloading with higher percentages of 1” (22%) and 3/4” (48%) on the rear face (greater momentum) and lower percentage of < 1/2” (-49%) on the rear face (fines concentrated on front face).

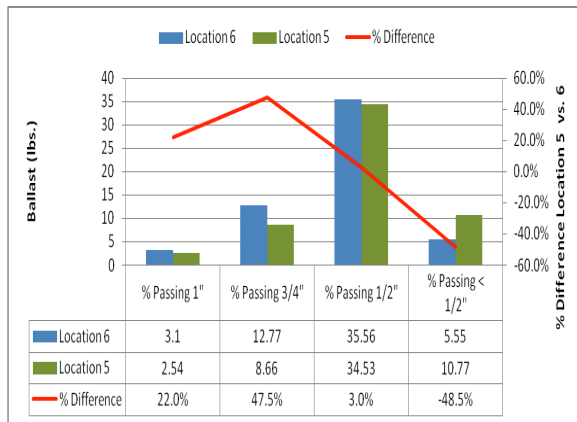

Figure 5 – Gradation Results

The boom of the belt train was able to support the additional weight of the prototype without failure. An inspection of the prototype following the unloading of twenty (20) railcars of ballast showed no signs of wear or tearing. A complete analysis of the prototype’s life cycle will be required at a later date to establish maintenance interval(s).

The most appropriate measure to evaluate the effectiveness of the prototype boom attachment is standard deviation relative to Union Pacific

Railroad’s ballast specification. Figure 6 provides the subject results. The figure clearly shows that the standard deviation of all ballast grades is significantly lower with the prototype installed versus not. Thus, segregation of ballast at any one location on a stock pile dumped with the prototype installed is significantly lower than without the prototype installed.

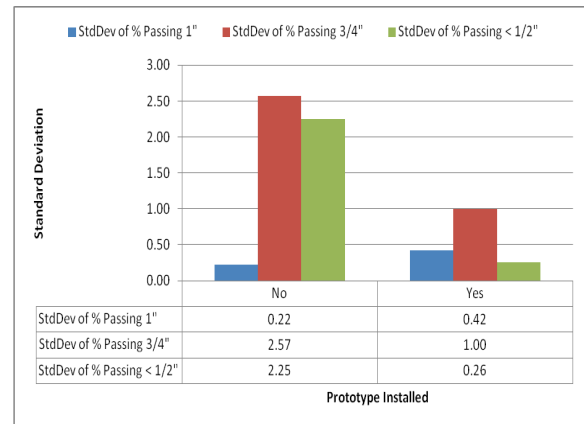

Figure 6 – Std. Deviation of % Passing

The only trade off in utilizing the prototype boom attachment was throw distance of the ballast. When the prototype was not installed the belt train had a maximum throw distance of forty (40) feet from end of tie. Once the prototype was installed the same throw distance was reduced to thirty-two (32) feet.

### In-Track Ballast Box Research

Performance of ballast materials under 36-ton axle load coal traffic is being investigated by Union Pacific Railroad in conjunction with the Transportation Technology Center, Inc. (TTCI), sponsored by the Association of American Railroads (AAR) and the University of Illinois at Urbana-Champaign. The investigation has a number of objectives, including:

- Measuring the rate of coal fine accumulation and the settlement behavior of the coal fines over time
- Measuring ballast degradation and track settlement of different ballast materials



- Measuring ballast pressures over time

The research was initiated in November 2010 with new ballast material from four separate Union Pacific Railroad sources, being installed on Track 2 of the South Morrill subdivision near Ogallala, NE. The South Morrill carries approximately 250 million gross tons (MGT) of coal traffic annually, primarily on Track 2, and is the location of the western HAL Revenue Service Test mega-site. The ballast is being sampled twice yearly and sieve analysis is performed to determine the change in the particle size distribution. Strength of the sampled ballast is being measured with a large scale triaxial test cell that was designed and fabricated under the direction of Dr. Erol Tutumluer at the University of Illinois Urbana-Champaign (UIUC).

Test zones for particle breakdown monitoring were established at a 2-degree curve and tangent location. The four ballast types are separated by steel boxes that are 14-feet long, 12-feet wide and with ballast depth beneath ties of about 14-inches, Figure 7.

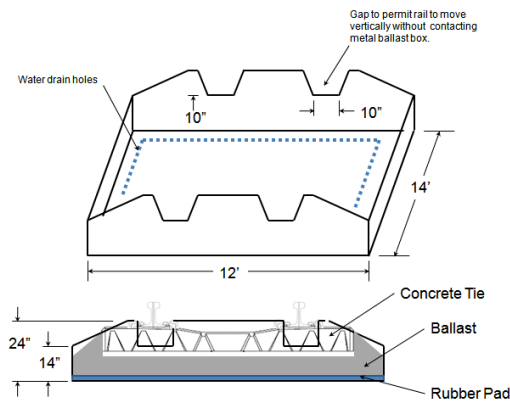

Figure 7 – Ballast Box Design

A total of 16 boxes were installed, 8 boxes in the curve zone and 8 in the tangent zone. The installation procedure involved removal of the existing track panel and ballast, placing the boxes at roughly the subgrade depth, filling the boxes with the new test ballast, reinstalling the track panel, and final surfacing and ballast dressing, Figure 8.



Figure 8 – Ballast Box Installation

The layout for both zones was the same with boxes 1 - 4 containing ballast Types 1 - 4 respectively, Figure 9.



Figure 9 – Ballast Box Installation

The Type 1 - 4 ballast is considered clean as it was sieved after being delivered and prior to being installed in the box so the material passing the 3/8-inch sieve did not exceed the AREMA 4a limit of 3-percent. The ballast in boxes 5 - 8 is designated as the control ballast which is the Type 2 material installed as delivered without additional sieving.

Ballast performance deteriorates as traffic and maintenance cause individual particles to fracture and wear. The change, or breakdown of ballast particles, is determined with sieve analysis (also referred to as gradation analysis) that measures the percentage of the total ballast sample weight that passes through various sieve sizes. In other words, the percentage of

the sample by weight that is smaller than a specific sieve size. The mainline ballast gradations recommended by AREMA generally limit the percentage of particles passing either a 3/4-inch or 1/2-inch sieve to less than 5-percent.

Sieve analysis was performed on samples of the new ballast prior to installation. Subsequent sampling and gradation analysis of the test ballast was performed in April and November 2011 and May 2012. A comparison of the percentages of the different ballast types passing the 1/2-inch, 3/8-inch and No. 4 (0.187-inch) sieve sizes at 0 MGT and 12 months later after accumulation of approximately 234 MGT is shown in Figure 10.

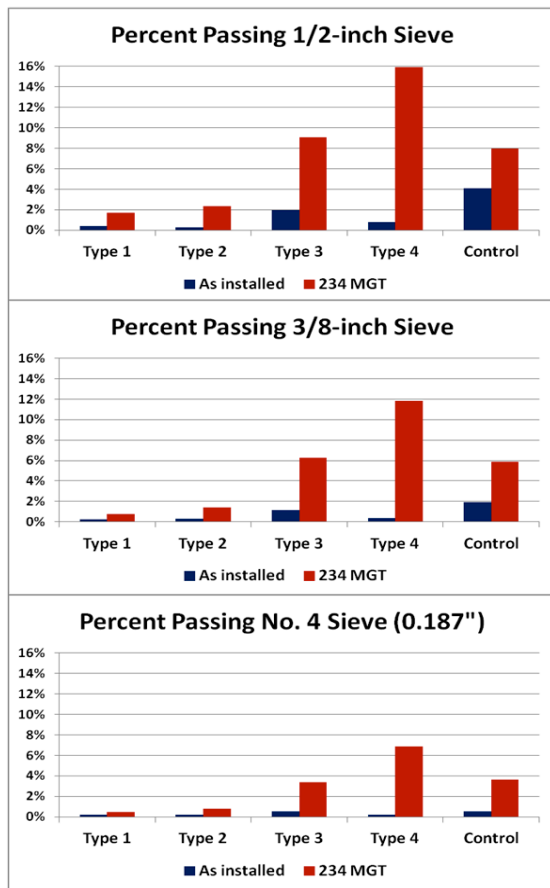

Figure 10

The Figure 10 data indicates that the as-installed gradations for all ballast types and the control ballast were all within the AREMA limits for material passing the 1/2 and 3/8-inch sieves. The data also shows that after 234 MGT, ballast Type 4 has degraded at a significantly higher rate in terms of particle breakdown than the other materials with 16-percent of the sample passing the 1/2-inch sieve compared to about 1-percent when installed.

Ballast behavior under loading can be studied in the laboratory through repeated load triaxial testing. Triaxial testing is a laboratory procedure where a cylindrical specimen placed in an air-tight container is subjected to repeated loads along its longitudinal axis while a constant surrounding or confining pressure is maintained on the specimen. The resilient (elastic) and permanent (plastic) deformation of the specimen is measured for each load cycle. The permanent deformation tends to increase with increasing load cycles and levels off after several thousand load cycles as the deformation stabilizes. This represents the reorientation of individual ballast particles to form a dense “stable” matrix. Deformation of the ballast layer is the primary cause of track settlement and uneven track settlement is the primary cause of track geometry problems.

A triaxial test device for testing 12-in. diameter by 24-in. high specimens has been designed and built by the University of Illinois at Urbana-Champaign (UIUC) specifically for ballast testing (TX-24). The ballast specimen is placed in three layers of latex membranes (each 0.029-in. thick) held in place with an aluminum split mold and is compacted using a vibratory hammer. A vacuum is then applied to the membrane and the mold is removed. Instrumentation on the test specimen includes a load cell to measure the applied repeated load and 3 longitudinal and 1 circumferential displacement transducers or LVDTs to measure the axial and radial deformations of the specimen as shown in Figure 11.

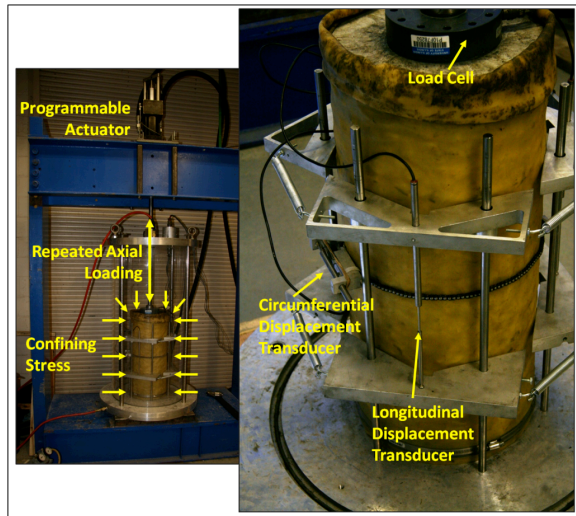

Figure 11: Photographs Showing (Left) the Specimen Setup Under the Loading Frame Ready to be Tested, and (Right) a Compacted Specimen with All Instrumentations Mounted

The repeated axial load pulse applied to the specimen via the closed-loop servo-hydraulic actuator setup is programmed to simulate realistic load levels experienced within the ballast layer upon the passage of a train. Each load pulse is 400-ms long, and is followed by a 600-ms rest period. Such a loading pattern represents the combined input generated by the trailing truck of the leading car and the leading truck of the trailing car, with the rest period representing the time lag before the next set of cars arrive. This loading pattern is roughly equivalent to a car with 40-foot truck centers operating at 40 mph. The current loading procedure, which is still in development, applies an axial deviator stress of 24 psi, at an all-round confining pressure of 8 psi. This represents a stress ratio (defined as the ratio between axial to radial stresses) of 4, and is believed to represent extreme ballast loading conditions where the applied deviator stress is significantly higher than the confining pressure. Testing each specimen to 10,000 load applications (or four log cycles) can provide a reasonable indication of ballast behavior under train loading. Testing was first performed on the April 2011 (126 MGT) ballast samples and no significant ballast breakdown had occurred at that point to reliably compare settlement potentials from the permanent deformation test results. Samples were also collected in November 2011 and May 2012. In

Figure 12, triaxial tests results are shown for the Type 4 ballast sample collected in May 2012 after the accumulation of approximately 234 MGT. Interestingly, even after 10,000 load applications the permanent deformation curves did not approach an asymptotic value. This may be due to the significant amount of particle degradation in Type 4 ballast as established from Figure 10. The high amounts of fines act as lubricants at the coarse aggregate contact points, thus leading to continual accumulation of permanent deformation. Further analysis of test results is expected to show some correlations between changes in ballast gradation or breakdown and accumulated permanent deformations.

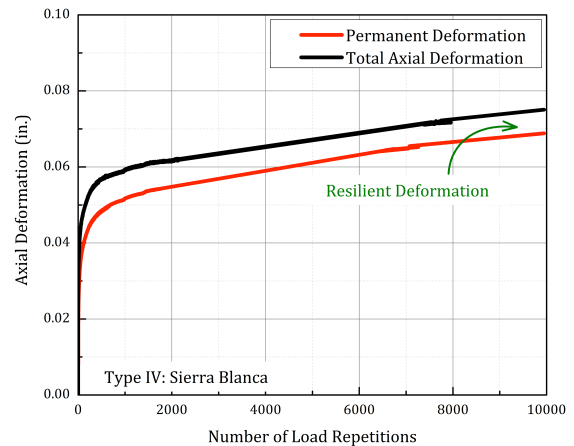

Figure 12 Permanent Deformation Trends of Type 4 Ballast after 234 MGT

Figure 13 compares the permanent deformation accumulation in the five ballast material types (Types 1 through 4, with type 5 representing the control ballast) collected in May 2012, after the application of 10,000 load repetitions. Interestingly Type 2 ballast showed the highest accumulation of permanent deformation, with Type 4 being the second. This appears to be in contradiction with the trend expected based on the gradation results. It is possible that the specimen tested for Type 2 ballast did not get adequate compaction before testing, thus accumulating very high deformations. However the permanent deformation accumulation in the other four ballast types were in expected order based on the gradation results (Type 4 > Type 3 > Type 5 > Type 1). Efforts are currently underway to conduct

additional testing of Type 2 material to justify possible anomalies in the test results.

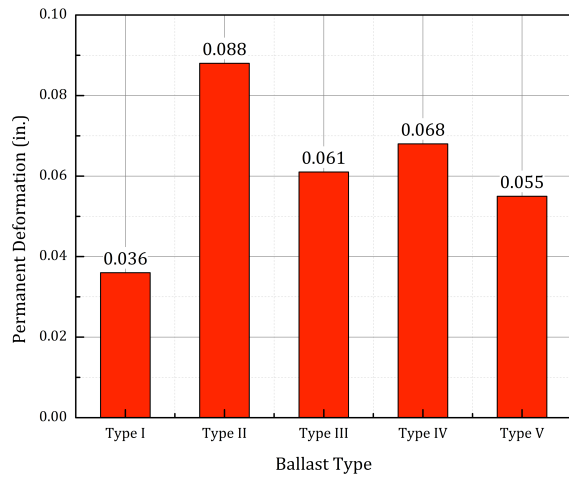

Figure 13 Comparisons of Permanent Deformation Trends of All Ballast Types Including Control Section (Type V)

#### References

AREMA, Manual for Railway Engineering (2012), Chapter 1



# 2012 Annual Conference & Exposition BALLAST RESEARCH

150 YEARS



**BUILDING AMERICA<sup>®</sup>**

**AREMA<sup>®</sup>**

September 16-19, 2012 • Chicago, IL

## Ballast Research

- Background
  - Union Pacific purchases on average \$50 million of ballast annually.
  - Union Pacific procures ballast material from thirteen (13) suppliers in nine (9) states in the western half of the U.S.



# 2012 Annual Conference & Exposition Strategic Objectives

- Define ballast life cycles (degradation)
- Identify and resolve sources of variation in ballast quality
- Quantify the impact surfacing operations have on ballast life cycle
- Quantify rate of ballast settlement
- Establish tiered standard for ballast
- Refine capital renewal intervals
- Improve risk model for adverse ballast conditions





### Ballast Quality

- Terracon taking samples from each quarry twice a month
- Web-based system developed to compile results of testing
- Ballast quality incorporated in yearly review for each supplier



## Ballast Wash Facility Research

- Objective:
  - Identify and resolve sources of variation in ballast quality
  - Evaluate the effectiveness of each supplier's wash facilities to remove fines.
- **Wash facility variables evaluated:**
  - Screen angle of inclination
  - **Spray bar configuration**
  - Spray bar volumetric output
  - **Agitation method**



Screen Angle of Inclination



Spray Bar Configuration



Spray Bar Volumetric Output



Agitation Method



## Ballast Wash Facility Research

- **Results:**

- 9 of 11 suppliers employ wash facilities capable of removing 75%+ of the fines.
- Most effective wash facilities incorporate:
  - Minimum of two wash decks with three being optimal
  - Auger equipment
  - Spray nozzle density of one per foot or less.
- UP continues to engage underperforming suppliers to improve wash facilities.

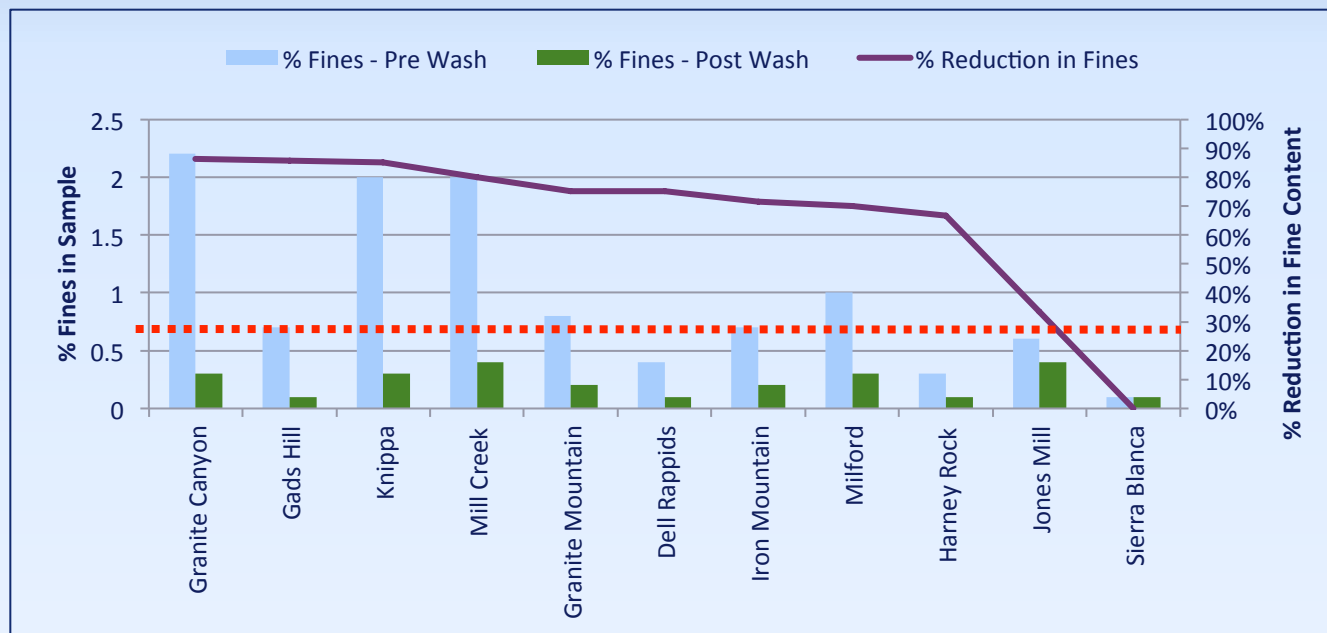

## Ballast Degradation in Transit

- Test completed in Kansas City using three different ballast sources



0.14% increase in minus ½" material per 100 miles

## Ballast Delivery Method Research

- Objectives
  - Quantify the level of segregation that occurs during ballast unloading from belt train.
  - Evaluate the effectiveness of the new prototype to eliminate segregation of ballast delivered via belt train.





# Ballast Delivery Method Research

- Procedure
  - Perform gradation analysis on stock piles unloaded with and without prototype installed.

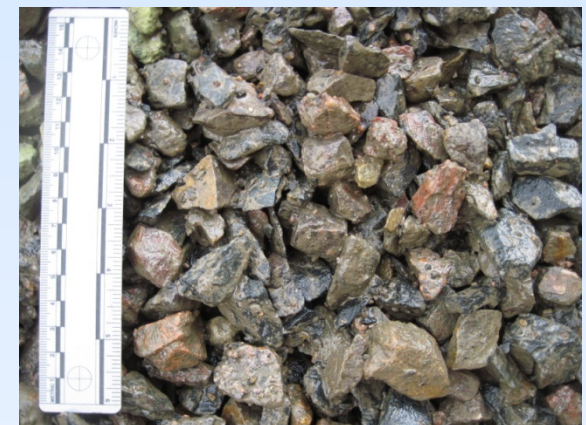
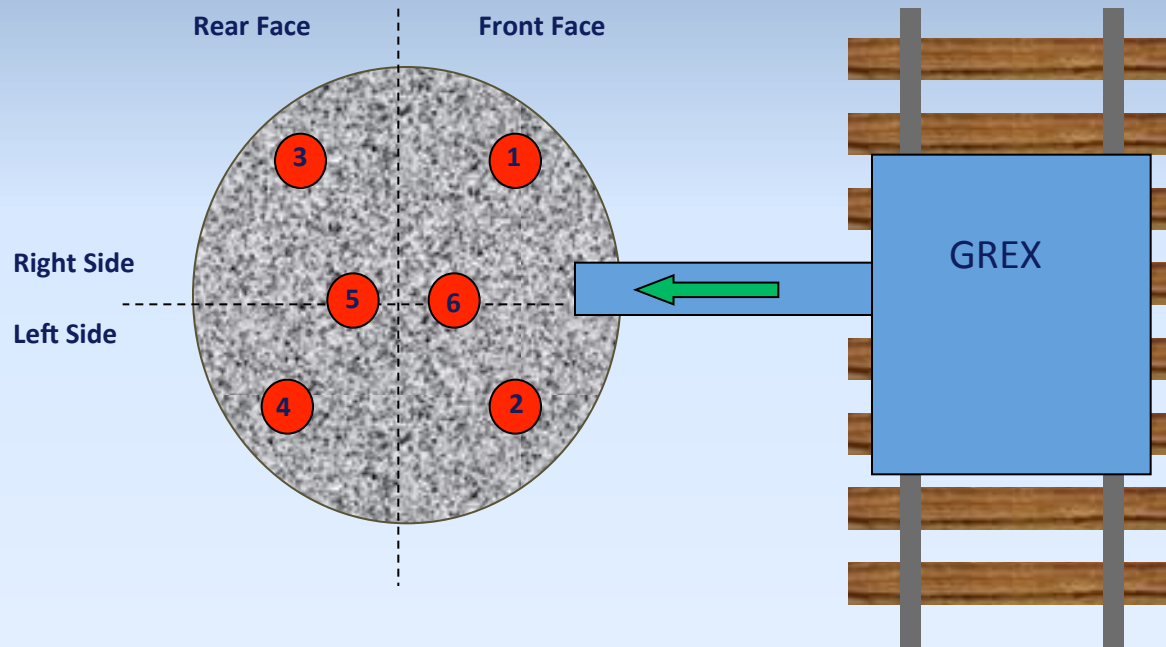

# Ballast Delivery Method Research

- Results
  - Standard deviation of all ballast grades is significantly lower with the prototype installed versus not.
  - Segregation of ballast at any one location on a stock pile dumped with the prototype installed is significantly lower than without the prototype installed.

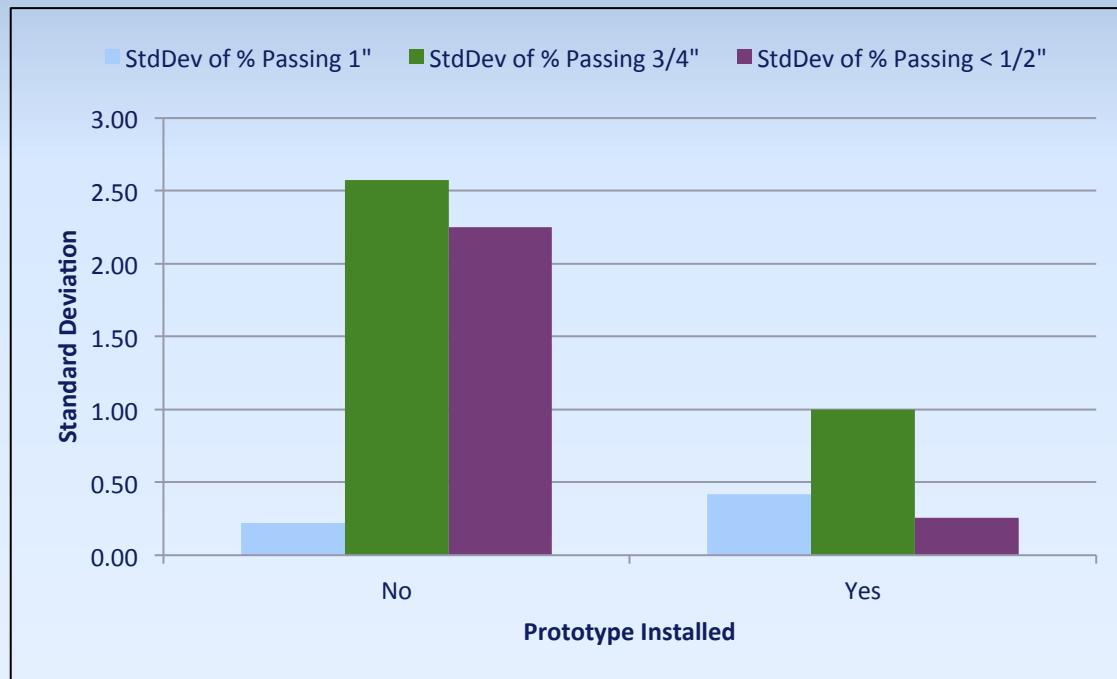



# In-Track Ballast Research

- Objectives
  - Define ballast life cycles (degradation)
    - Intrinsic properties
    - In-track operating conditions (i.e. tonnage)
    - Quality
  - Quantify the impact surfacing operations have on ballast life cycle
  - Quantify rate of ballast settlement
  - Establish tiered standard for ballast
  - Refine capital renewal intervals

## In-Track Ballast Research

- Procedure

- Perform laboratory (ASTM) and gradation testing on 400 tons of ballast from four suppliers.



- Install 16 ballast boxes in heavy haul territory (Western Mega Site).



## In-Track Ballast Research

- Ballast boxes 12' W x 14' L with 0.25" thick steel.
- Ballast boxes in curve include steel bottom and liner while those in the tangent have no steel bottom.
- Two pressure cells installed in a total of 6 ballast boxes.





# In-Track Ballast Research





# In-Track Ballast Research



## In-Track Ballast Research

- Progress:
  - 3 ballast samples taken from each box at approximately 6 month intervals.
  - Ballast gradation envelopes evaluated for each sample set.

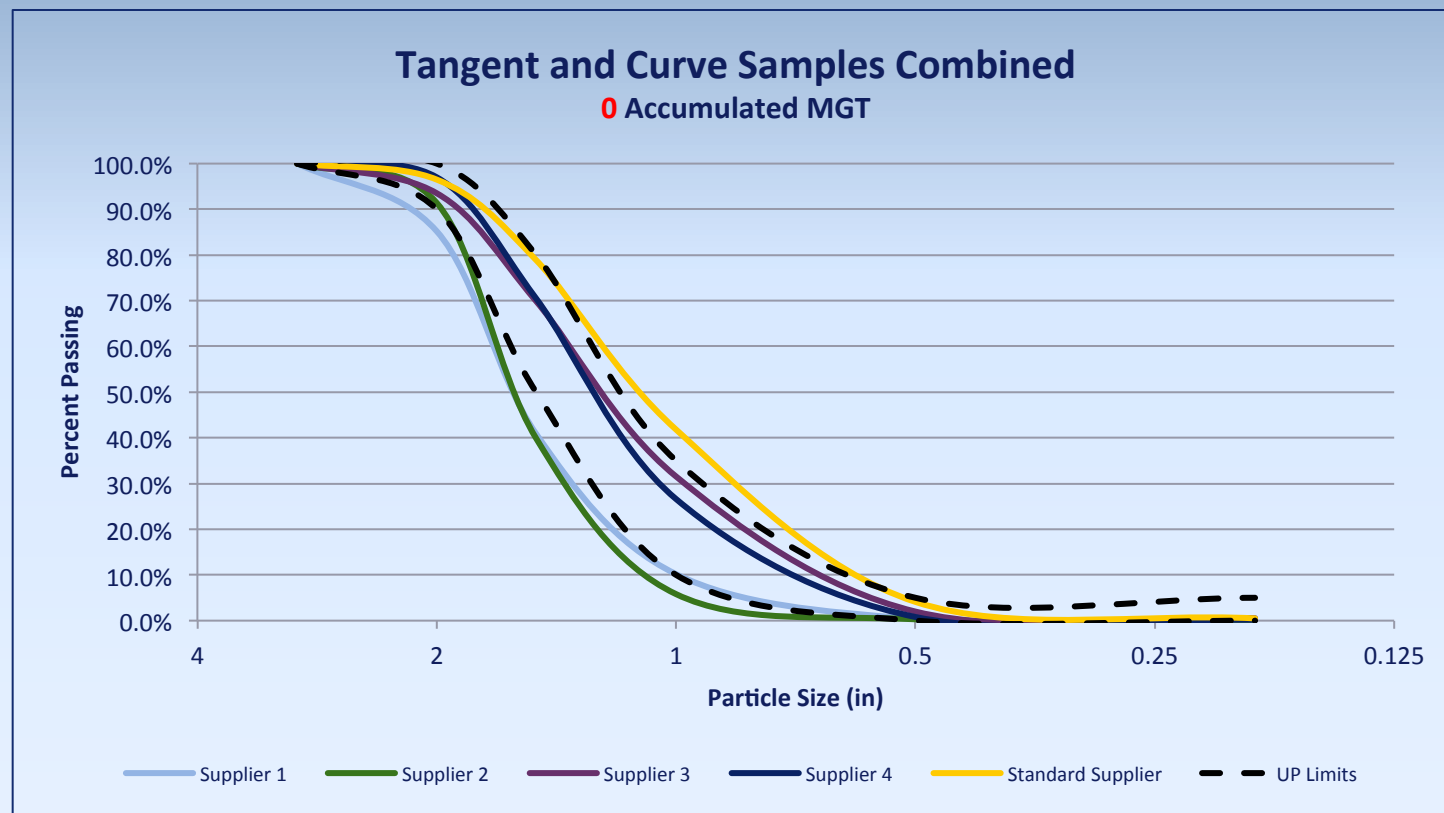

# 2012 Annual Conference & Exposition In-Track Ballast Research

- Preliminary Results:
  - Comparison of percentage of sample weight passing 1/2-inch and No. 4 sieves.

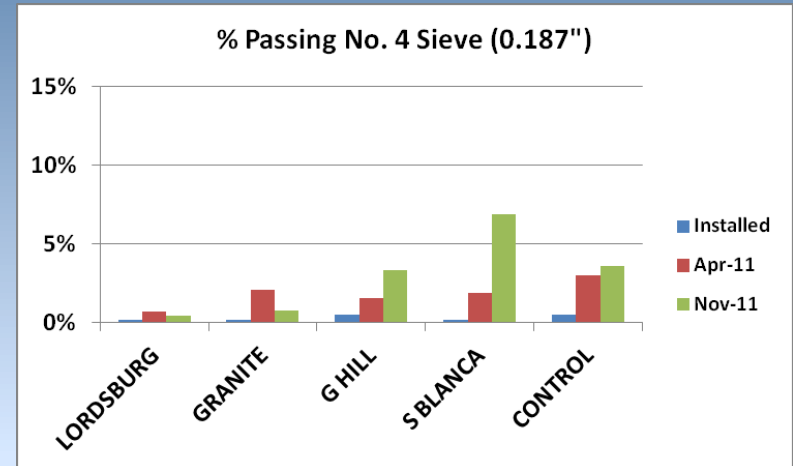
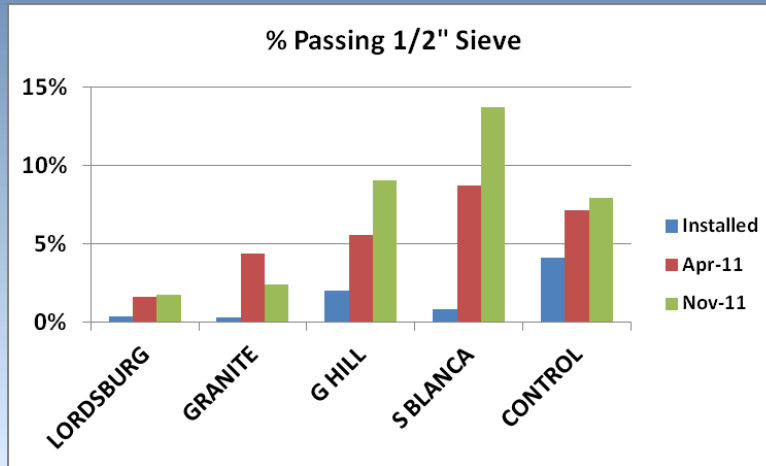

- Increase in % material of total weight passing 3/4", 1/2", 3/8" and No. 4 sieves.

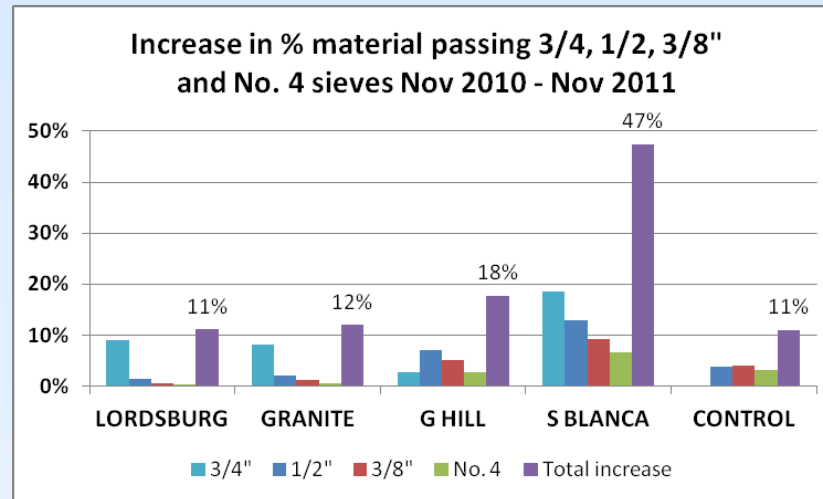



# Laboratory Ballast Testing at Univ. of Illinois - Repeated Load Triaxial Test Device

12-in. diameter, 24-in. high cylindrical specimens

- MTS actuator capable of applying 100 kN (22 kip) dynamic loading
- On-Specimen Load Measurement (20-kip capacity)
- 3 axial LVDTs located at 120° to measure on-sample axial deformation (range =  $\pm 1$  in.)
- 1 circumferential LVDT (range =  $\pm 0.5$  in.) for measuring change in sample diameter



# Repeated Load Triaxial Testing of Ballast Box Materials

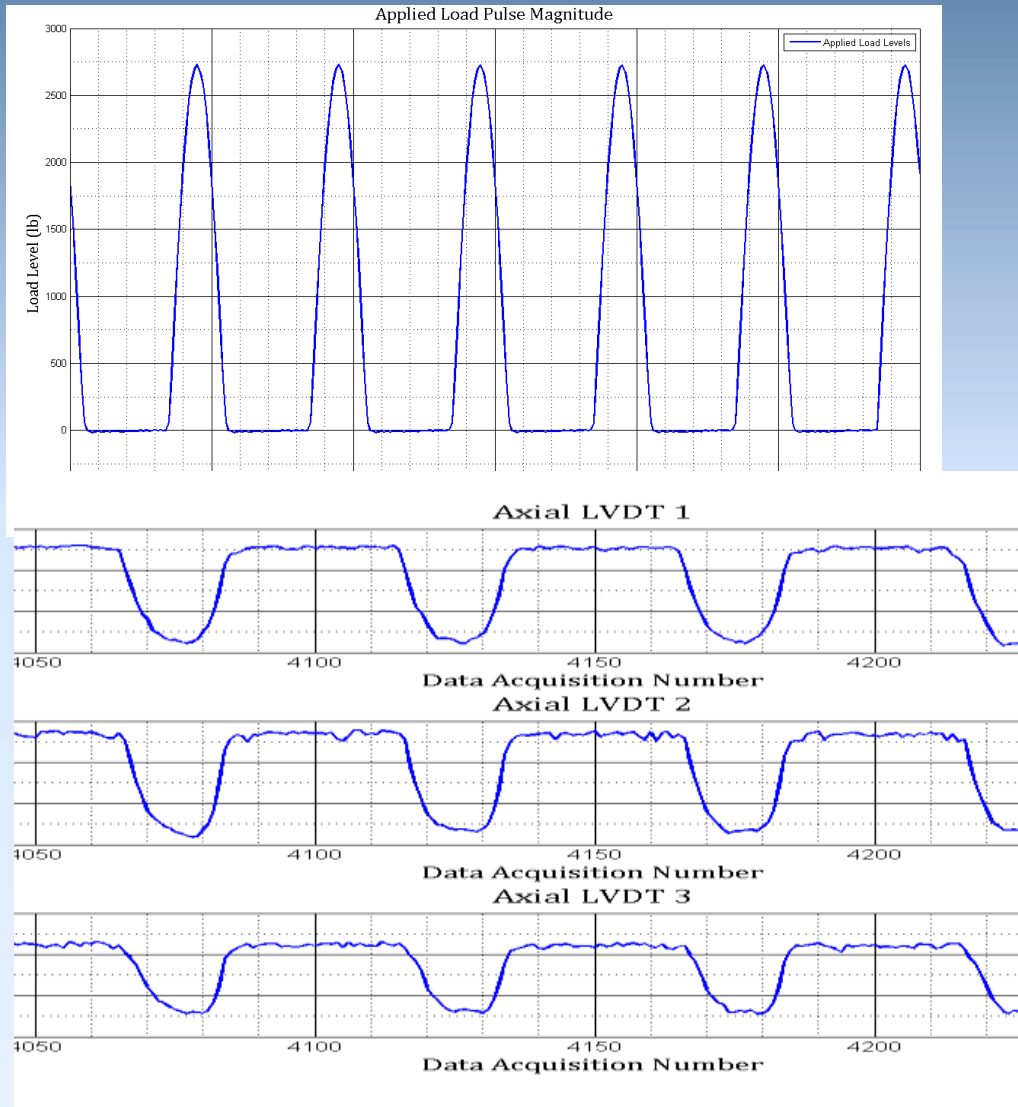

- 8 psi confining pressure
- 24 psi deviator stress  
( $\sigma_1 / \sigma_3 = 4$ )
- Haversine load pulse
  - 400 ms pulse duration
  - 600 ms rest period
- 10,000 load application

# 2012 Annual Conference & Exposition Modulus & Permanent Deformation Test Results Control Ballast: Type V

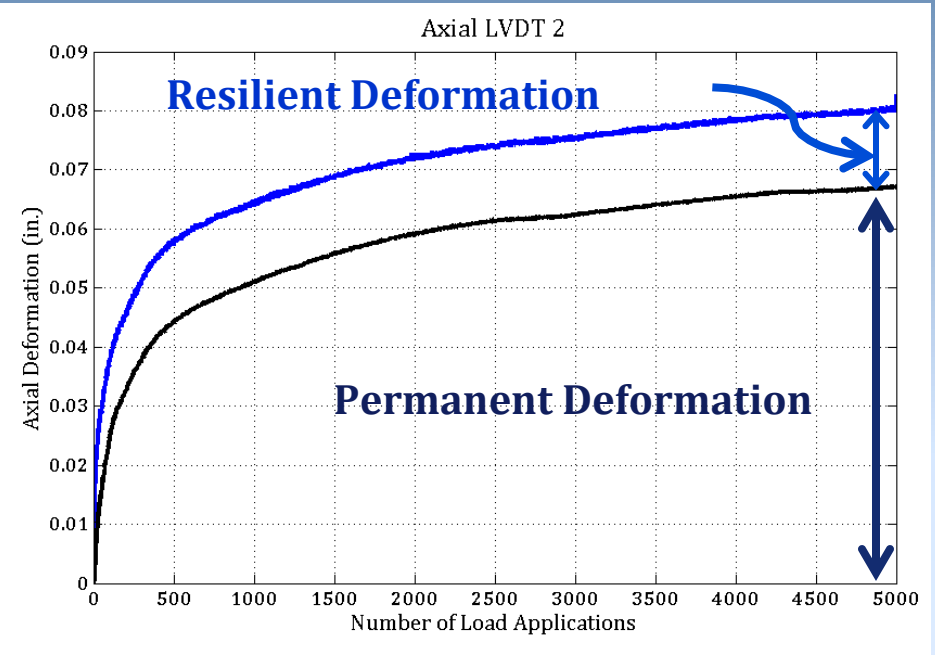
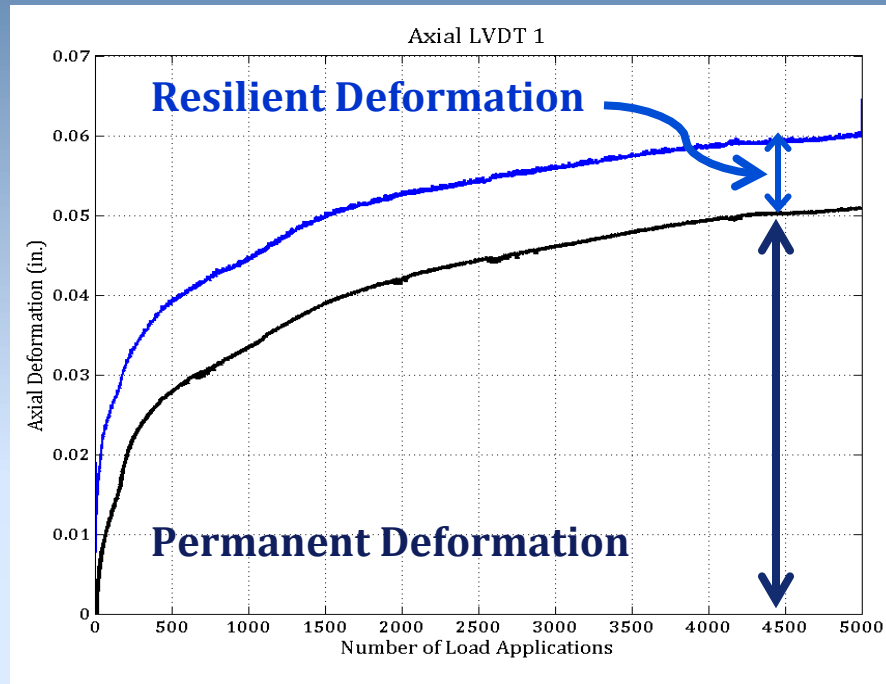

- Average Permanent Deformation after 5000 cycles: **0.059 in. (0.56%)**
- Average Resilient Deformation after 5000 cycles: **0.015 in. (0.14%)**
- Average Resilient Modulus after 5000 cycles: **34,200 psi**

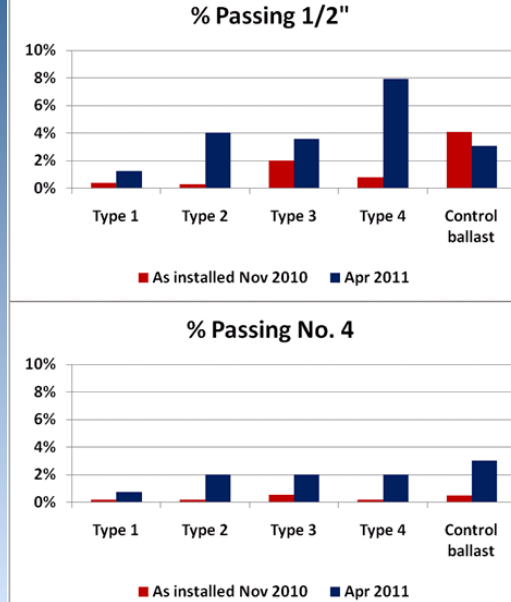
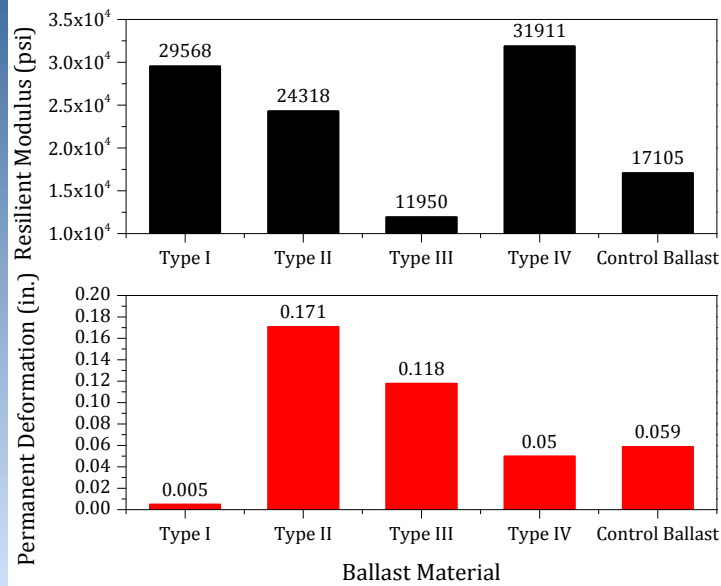

Ballast Material	Fouling Index		Percent Fouling	
	Before Compaction	After Compaction	Before Compaction	After Compaction
Type I	0.3	0.4	0.4	0.4
Type II	2.8	0.2	3.0	1.2
Type III	3.0	1.3	3.8	2.5
Type IV	1.5	1.4	3.1	3.3
Control	4.1	4.1	5.6	5.6

**Fouling Index: % Passing Sieve # 4 + % Passing Sieve # 200**

**Percent Fouling: % Finer than 3/8 in. (9.5 mm)**

Effect of Gradation on Modulus and Permanent Deformation Trends



# 2012 Annual Conference & Exposition

## Shear Strength Testing of New Ballast Sources

- **Large Direct Shear Equipment**

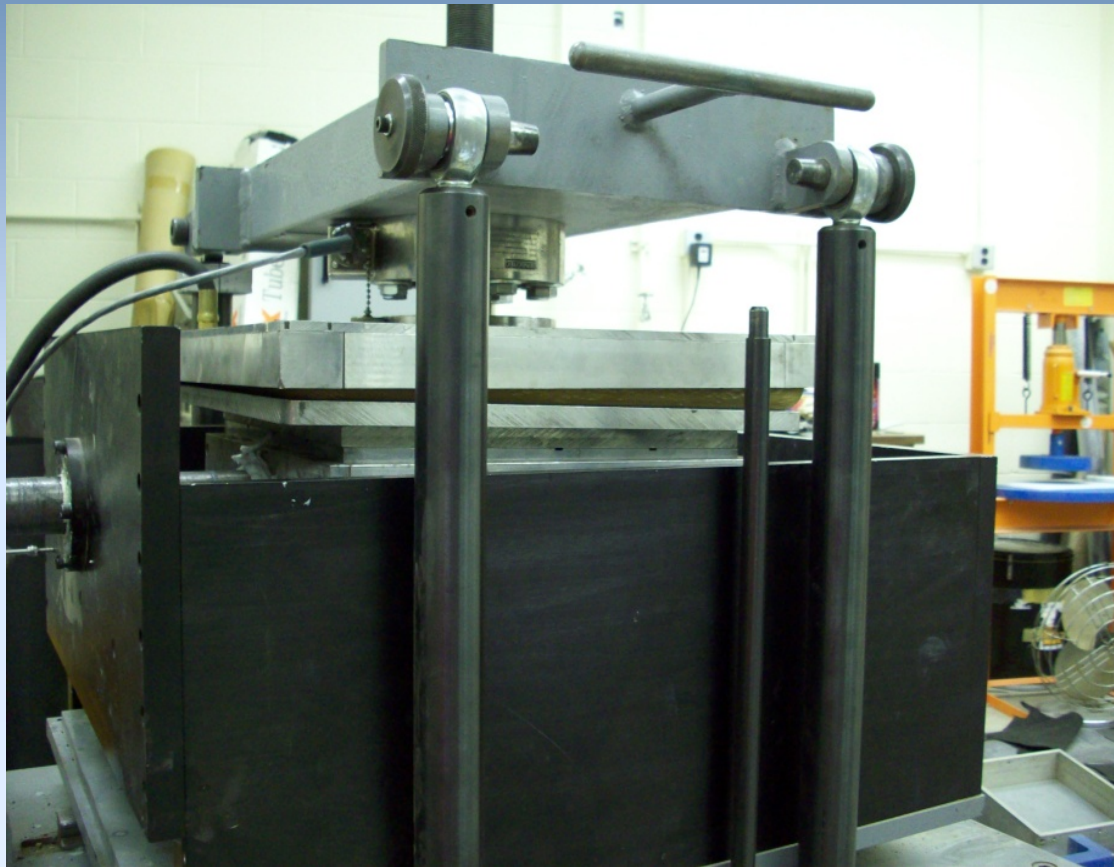

**12 in. x 12 in.  
square box**

**8-in. deep lower box  
4-in. deep upper box**

**up to 30-kip loading**

- Three normal pressures (25, 35, and 45 psi)
- Shearing rate: 0.38 in./min; Maximum strain recorded: 15%

# Shear Strength Testing of New Ballast Sources

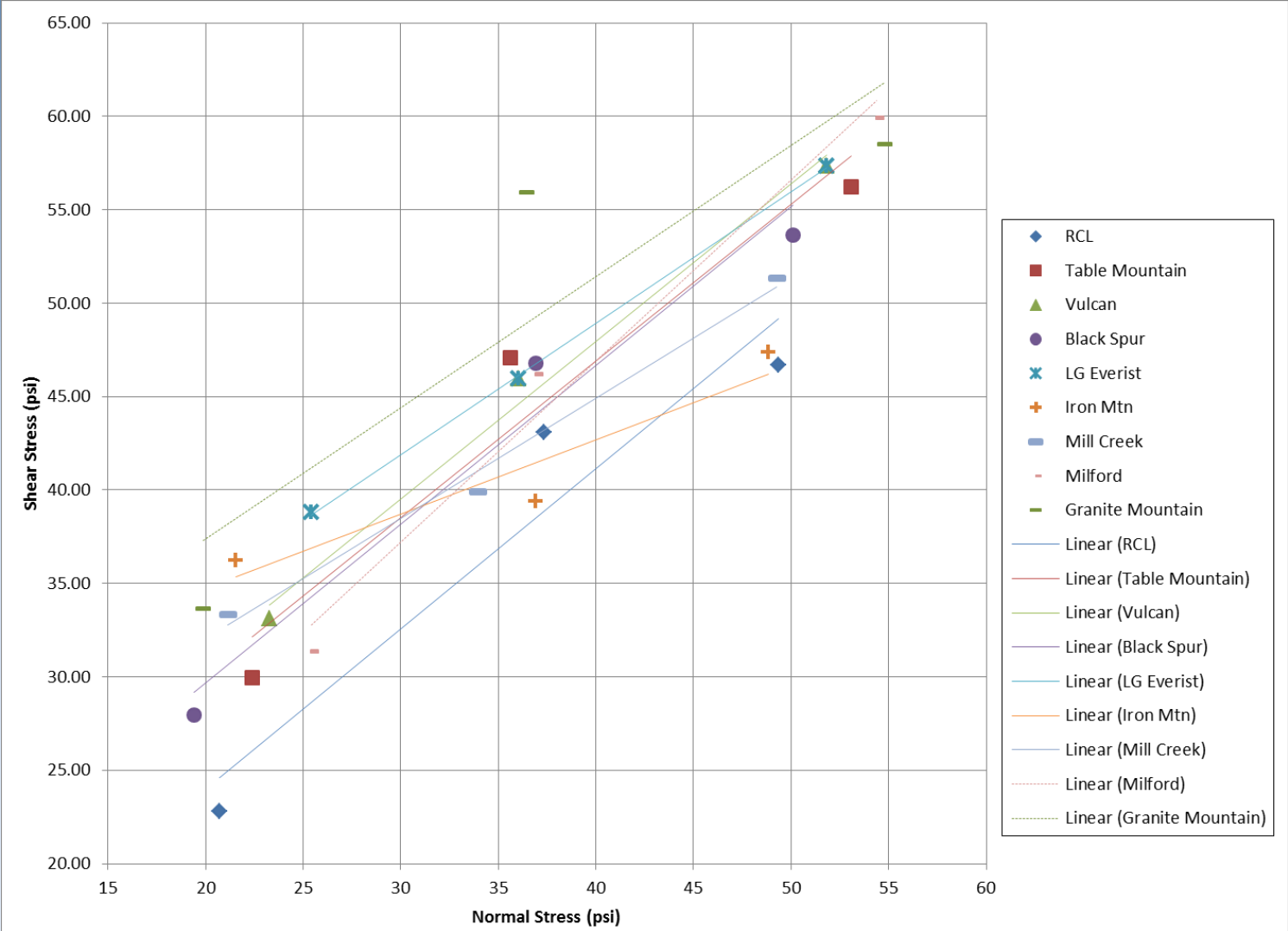

## Ballast Degradation vs. Tamping Cycles

- Objectives:
  - Quantify the impact surfacing operations have on ballast life cycle
  - Establish tiered standard for ballast
  - Refine capital renewal intervals





# Ballast Degradation vs. Tamping Cycles

- Laboratory testing of ballast:



Ballast Loaded



Equipment Setup



Gradated Ballast



Tamping Head Engaged

# Ballast Degradation vs. Tamping Cycles

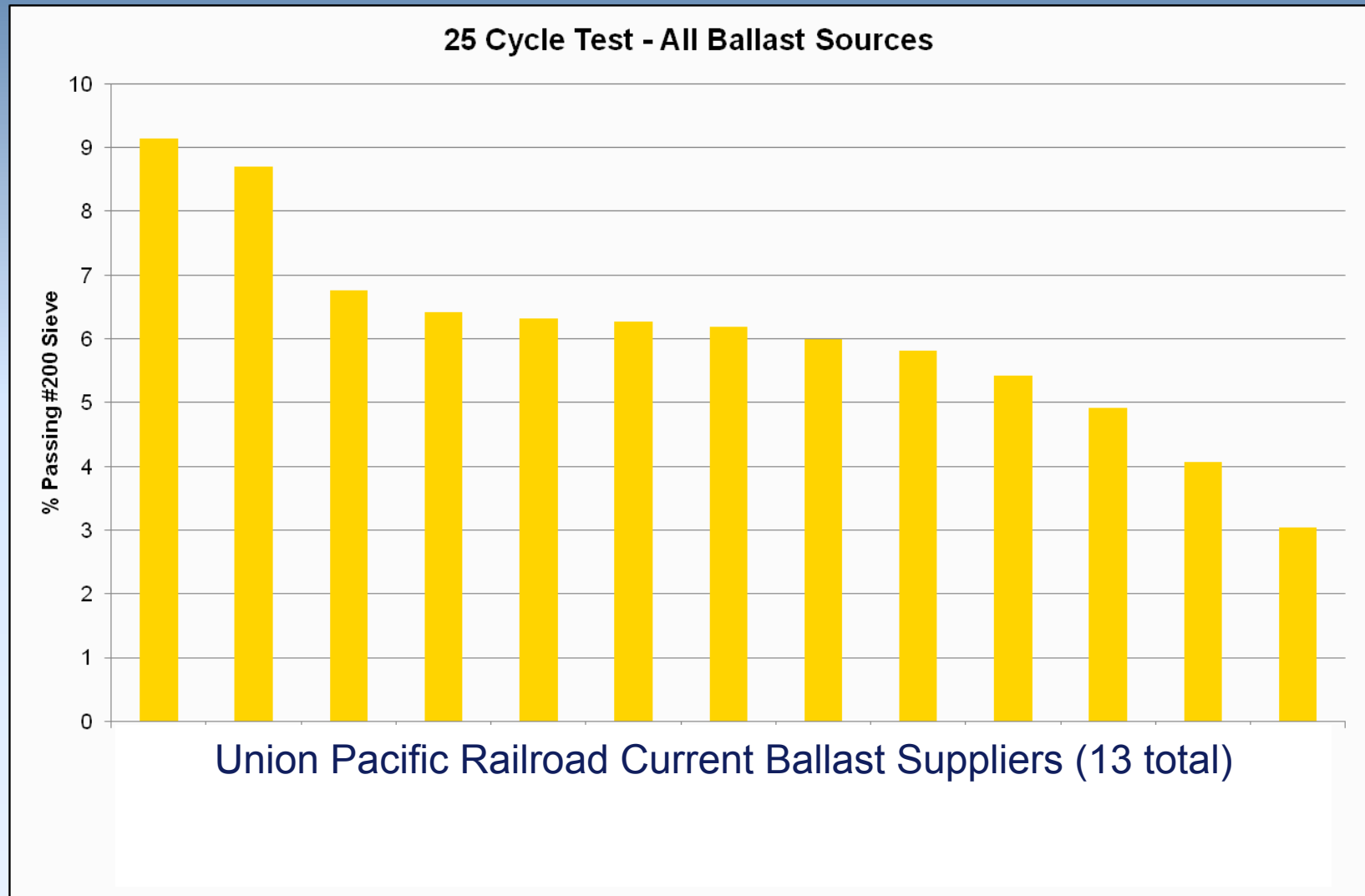

### Key Physical Shape Properties of an aggregate particle

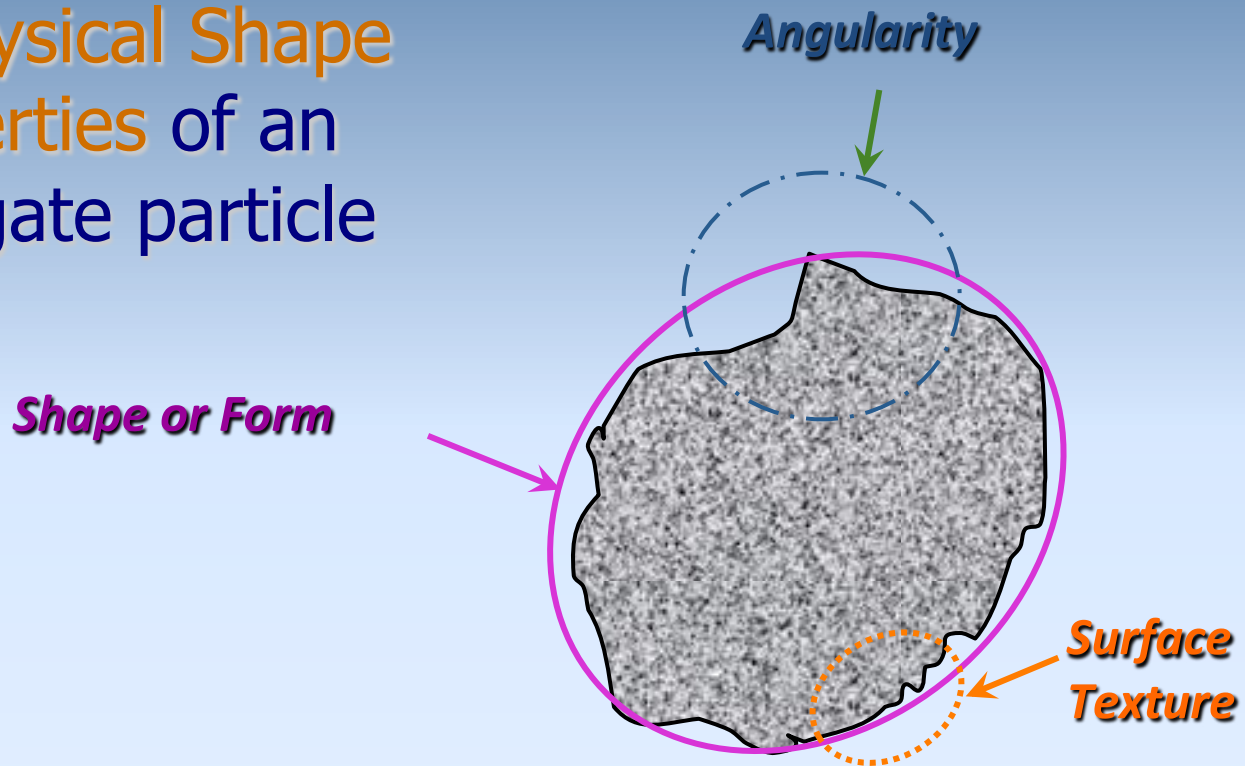

***Roughness or irregularity at a micro level  
in contrast with angularity at a macro level***



# Imaging Based Evaluation of Ballast Shape Properties Using Three Orthogonal Views

## University of Illinois Aggregate Image Analyzer (UIAIA)



Ballast  
Processed  
through  
**UIAIA**

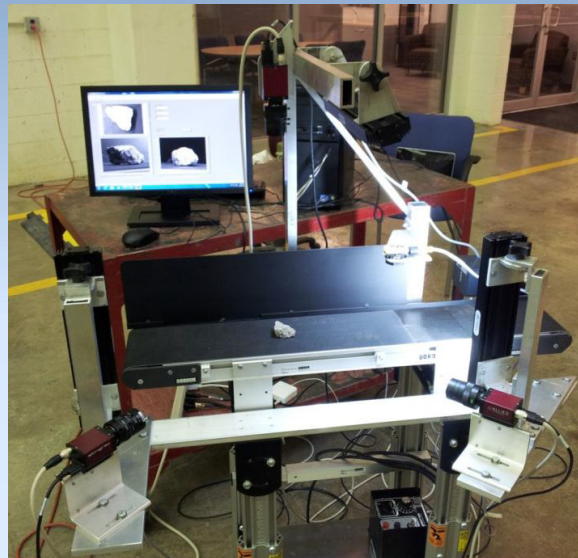

*Tutumluer et al. (2000)*  
*Rao et al. (2002)*

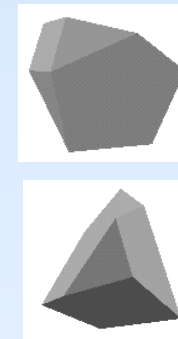
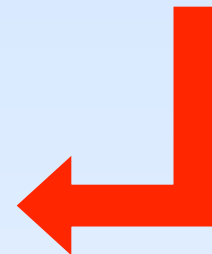

3D Polyhedrons

### **Ability to Quantify Ballast Shape**

- Flatness & Elongation
- Angularity Index
- Surface Texture Index
- Surface area
- Volume

Element Built in DEM  
with Desired Shape Properties

# Imaging Based Flat & Elongated (F&E) Ratio

**F&E Ratio = Longest dimension / Shortest dimension**

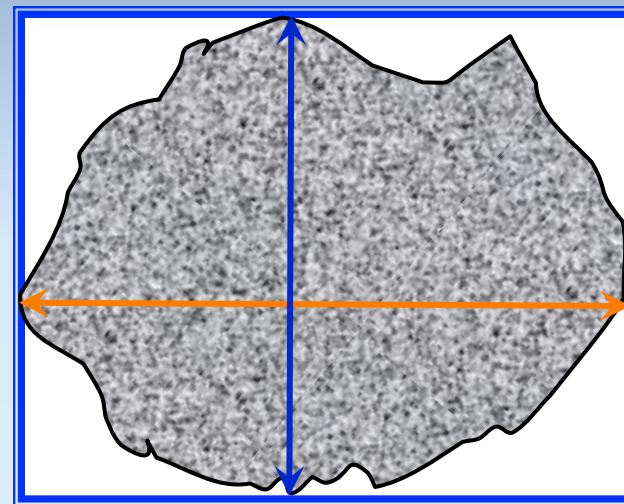
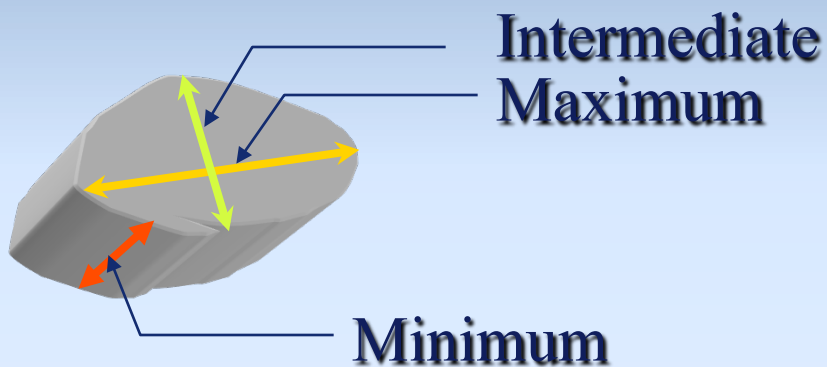

**Shortest dimension,  
Perpendicular to the  
Longest Dimension**

**Longest Dimension**

All 3 views are analyzed for the longest and shortest dimensions

AREMA specs require maximum 5% by weight over 3:1 ratio

# Imaging Based Angularity Index (AI)

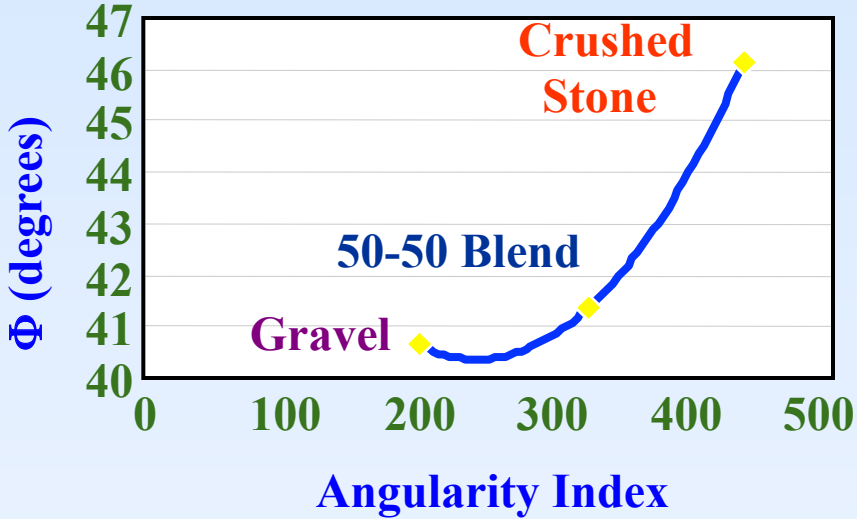
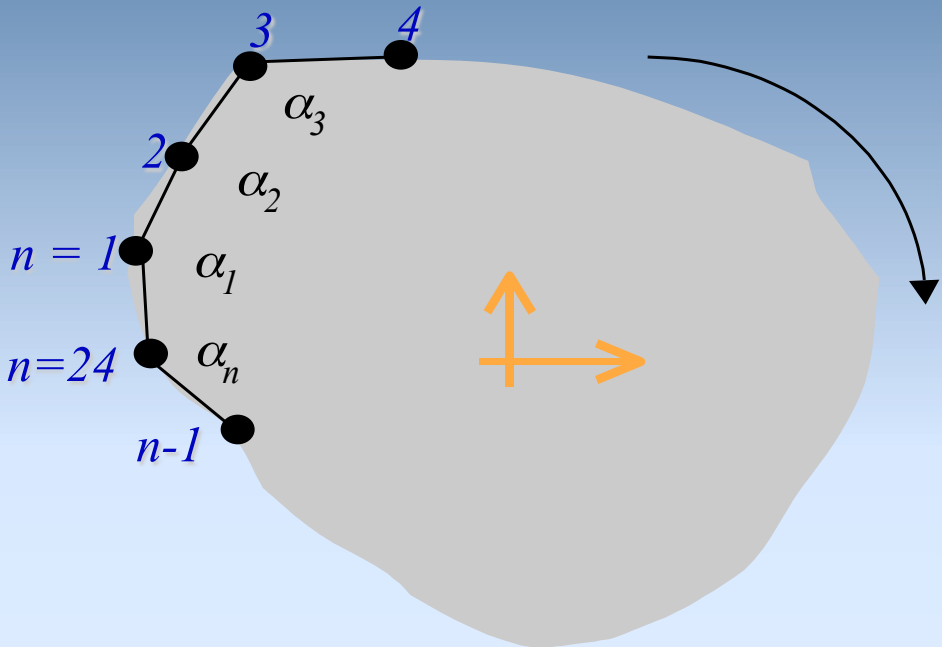

AREMA specs require ballast aggregates to be angular particles with sharp corners and cubical fragments



## Imaging Based Surface Texture (ST) Index

### Computation of Surface Texture (ST) Index

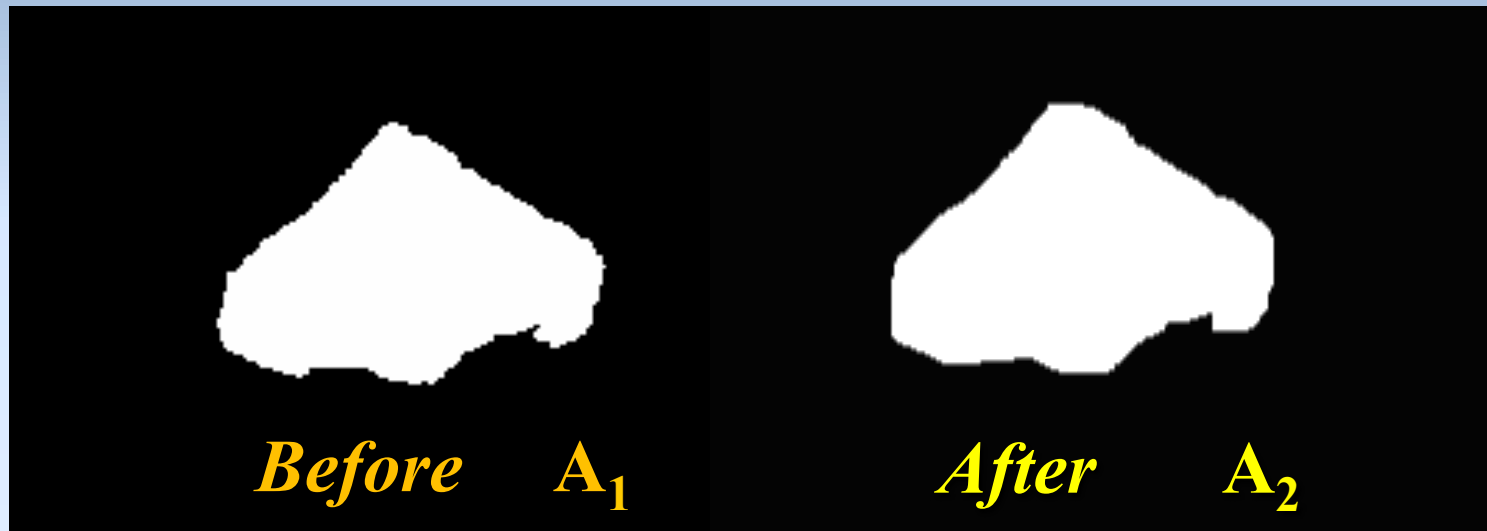

**Equal number of Erosion and Dilation cycles:**

**ST Index = Weighted average of  $(A_2 - A_1)$  from all 3 views**

# Shape Properties of Selected Ballast Materials from Different Sources

Ballast Material	Aggregate Source	F&E Ratio	Angularity Index (AI)	Surface Texture (ST) Index	Gradation Uniformity
I	Iron Mountain Trap Rock (Iron Mountain, MO)	1.9	<b>378</b>	1.1	Cu = 1.72 Cc = 1.03
II	Black Spur Quarry Granite (Uvalde, TX)	2.0	<b>426</b>	1.6	<b>Cu = 2.38</b> Cc = 1.04
III	Table Mountain Quarry Granite (Oroville, CA)	2.0	<b>601</b>	<b>3.1</b>	Cu = 1.44 Cc = 1.09
IV	RCL Rocks Granite (Sierra Blanca, TX)	<b>3.7</b>	<b>434</b>	<b>2.2</b>	<b>Cu = 1.75</b> Cc = 0.99

# Ballast Aggregates Tested in LA Abrasion (ASTM C535-09)



The number of LA drum turns varied: 100, 250, 400, 550, 700, and 1000



# 2012 Annual Conference & Exposition Gradations of Degraded Ballast

## Percent Fouling: Passing 3/8" (9.5 mm) sieve size

	100 Turns	250 Turns	400 Turns	550 Turns	700 Turns	1000 Turns
Granite	5.09	8.60	11.52	14.02	17.33	20.34
Limestone	8.18	9.26	14.71	15.51	19.99	24.15

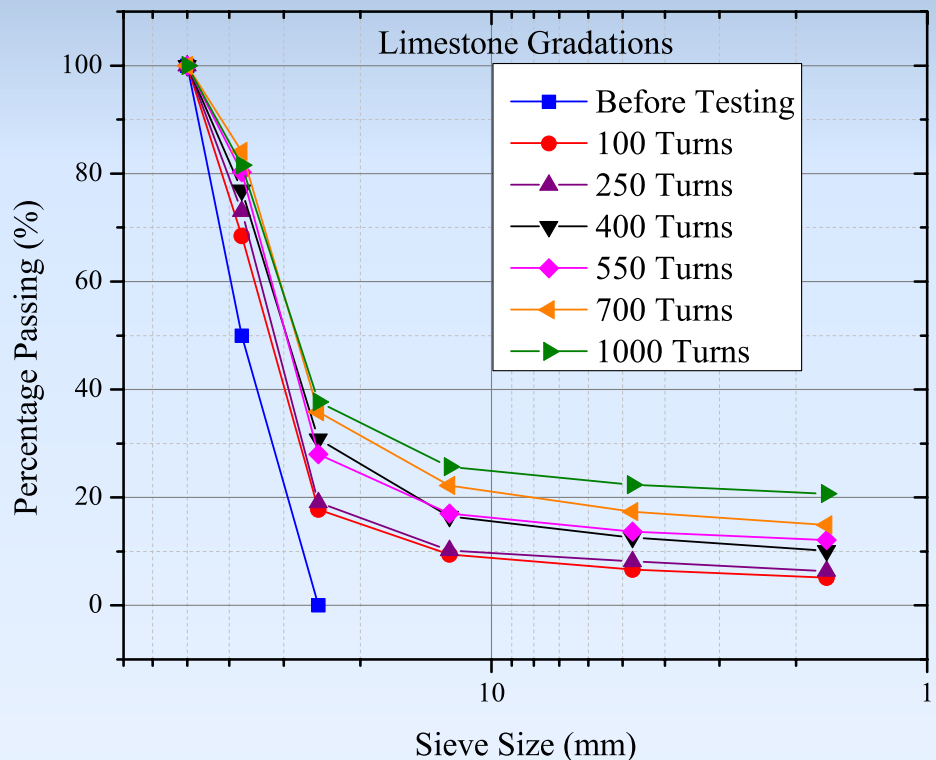
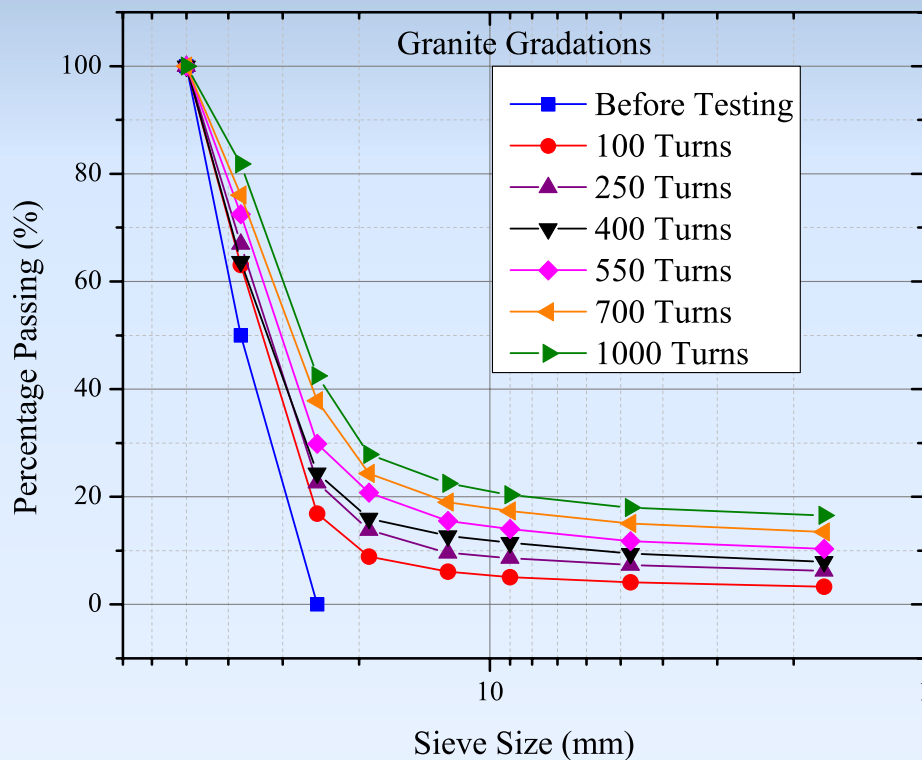

# Angularities Indices (AI)

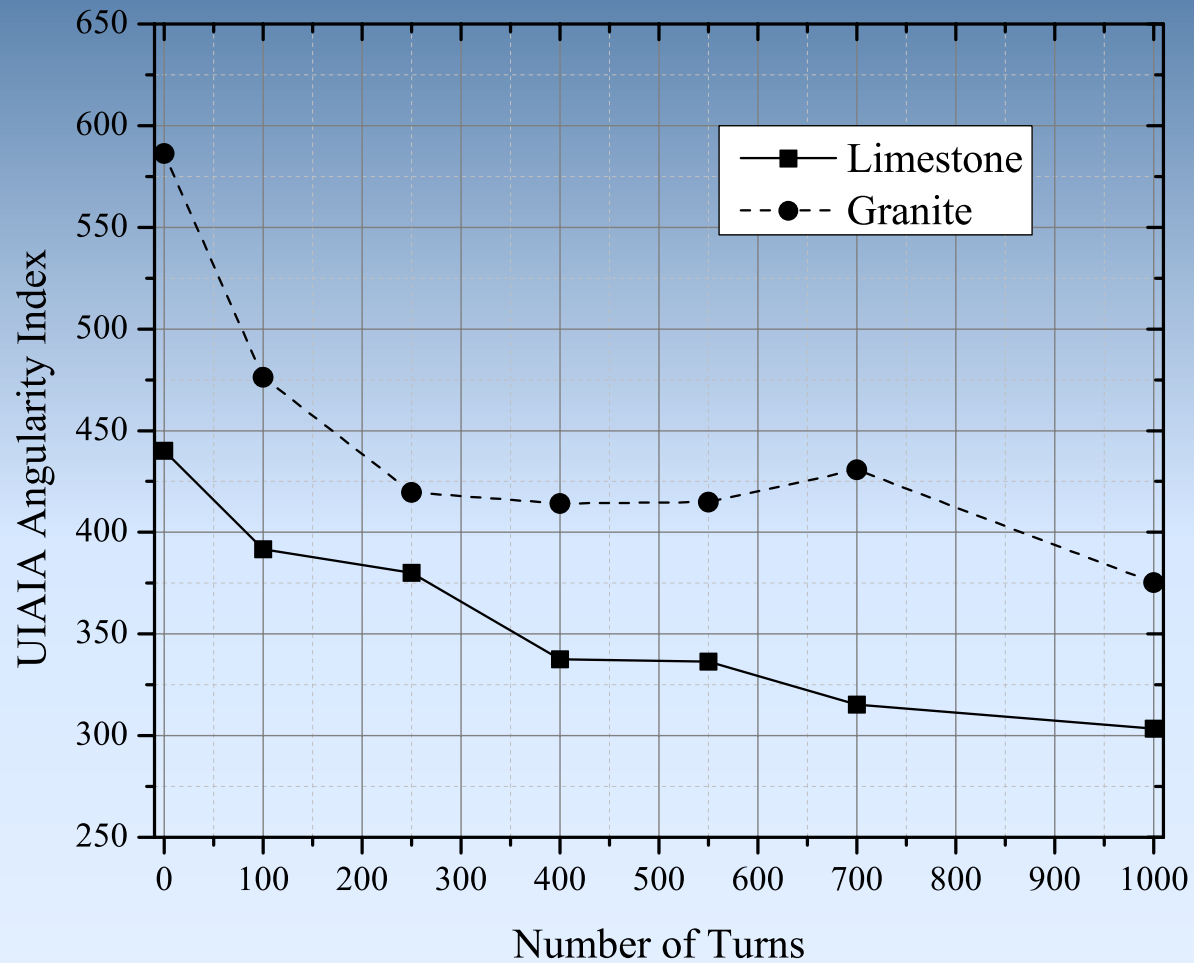

The rate of decrease in Angularity Indices (AI) becomes less after about 400 turns since particles become quite rounded

# F&E Ratios

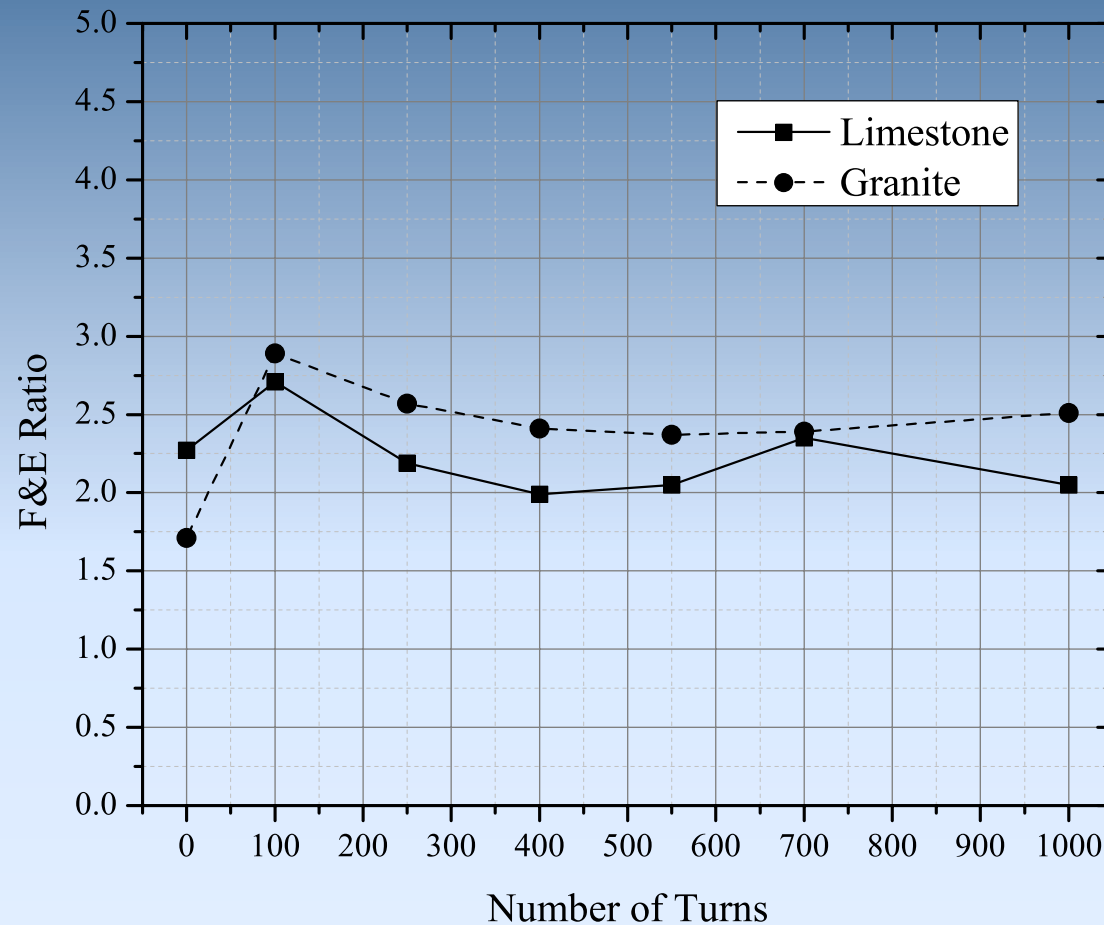

The F&E ratios do not change significantly as particle crashing is controlled by mineralogy



# Surface Texture (ST) Indices

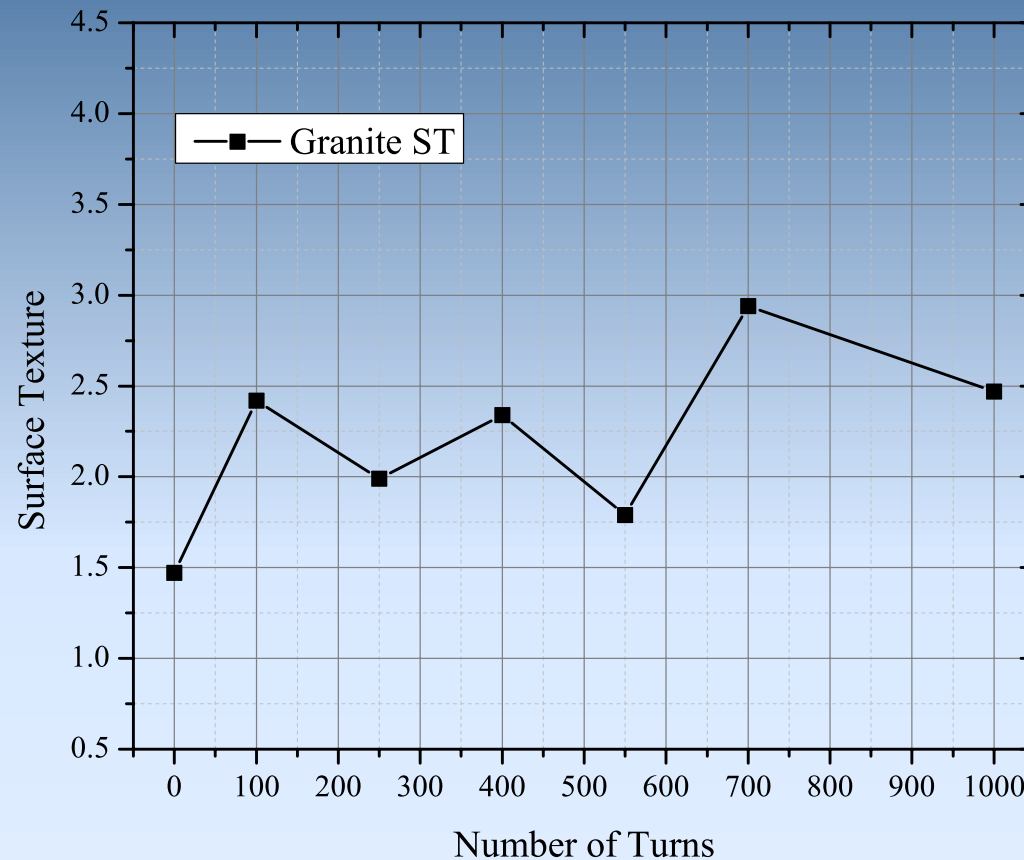

Increasing trends in surface roughness of aggregates for the granite samples (new crushed faces form with rough surfaces during LA Abrasion test)

2012 Annual Conference & Exposition

# QUESTIONS?



**BUILDING AMERICA®**

**AREMA®**

September 16-19, 2012 • Chicago, IL