

IMPACT OF AUTOMATED CONDITION MONITORING TECHNOLOGIES
ON RAILROAD SAFETY AND EFFICIENCY

BY

BRYAN SCHLAKE

THESIS

Submitted in partial fulfillment of the requirements
for the degree of Master of Science in Civil Engineering
in the Graduate College of the
University of Illinois at Urbana-Champaign, 2010

Urbana, Illinois

Advisers:

Professor Christopher P.L. Barkan
Lecturer J. Riley Edwards

ABSTRACT

The effectiveness and efficiency of railcar inspection is critical to freight railroad operations, as it directly affects safety, reliability, mainline efficiency, and terminal performance. Current railcar inspection practices are intended to identify defects prior to failure, but they generally do not provide predictive maintenance capabilities due to the limitations of manual, visual inspection. As a result, automated condition monitoring technologies (ACMT) have been developed to monitor rolling stock condition and facilitate predictive maintenance strategies. Through improved railcar condition monitoring, these technologies have the potential to reduce: equipment-caused derailments and in-service failures (ISFs), train delays and variability in mainline operations, and operational waste in railroad terminals.

In this thesis, I applied lean manufacturing methods to the railcar maintenance process, quantifying both direct and indirect waste. To assess benefits to mainline efficiency, I used dispatch simulation software to quantify the length and variability of equipment-caused ISFs as a function of traffic level. To assess benefits to terminal efficiency, I compared the railroad terminal to a manufacturing production system and used lean production techniques to identify sources of waste and variability. The results of these analyses indicate that the cost-savings from improved mainline and terminal efficiency through the use of ACMT are comparable in scale to the cost-savings from the potential reduction in equipment-caused derailments. I also present the results of a study investigating the feasibility of a machine vision system to automatically inspect freight car structural underframe components. This research provides a basis for evaluating strategies for cost-effective integration of railcar inspection technology, improved railcar maintenance, and future analyses pertaining to of implementation of ACMT.

Dedicated to my Supplier (John 15:5)

ACKNOWLEDGMENTS

There are many people in the railroad industry, at the University of Illinois at Urbana-Champaign (UIUC), and elsewhere in my life who have made valuable contributions to the story associated with the writing of my master's thesis. I am grateful to each one. Acknowledgements are good.

I would first like to thank John Friedmann at Norfolk Southern who hired me as a Transportation Management Co-op in Decatur, IL starting in the summer of 2005. I am grateful to Mr. Friedmann, Kathy Miles, Mike Murphy, and many others at Norfolk Southern for welcoming me into the railroad industry family, teaching me how to be a railroader, and inspiring me to pursue a future in railroad engineering. I would like to thank two other groups that invested in my undergraduate education and provided motivation to pursue additional education and a future occupation in railroad engineering. The American Association of Railroad Superintendents (AARS) and the American Railway Engineering and Maintenance-of-Way Association (AREMA) both awarded me academic scholarships, and I am sincerely thankful to both organizations for this support and vote of confidence. I would also like to thank several groups of people responsible for financially supporting my graduate research. Thanks to the Association of American Railroads for funding the Automated Inspection of Structural Components (AISC) feasibility study. I also thank CN for investing in the future of the US railroad industry through support of university research in the form of a University of Illinois Railroad Engineering Research Fellowship. I am also thankful to those responsible for the George Krambles Transportation Scholarship Fund. The travel opportunities provided by this fund have been invaluable in contributing to the quality my graduate education at the University of Illinois.

Next, I would like to thank the many industry professionals who made my master's research possible. Thanks to Bill GeMeiner, Garry Haddock, Steve Beckwith and Brian Davis from Union Pacific (UP) for their technical guidance and the use of railcar inspection and repair data. Thanks as well to Hayden Newell and Nate Stoehr from Norfolk Southern, Don Lauro from CSX, and Darrel Iler from CN for assistance and insight regarding mainline train delay. Thanks to those at the Belt Railway of Chicago, BNSF, CN, Canadian Pacific (CP), CSX, Norfolk Southern, and UP for allowing yard visits and opportunities to accompany car inspectors on train inspections. Thanks especially to the car inspectors at each of those railroads for answering my many questions, providing new and valuable perspectives on both freight car inspection and life in general, and inspiring me to pursue technological improvements in the railroad industry that will both add value to their profession and improve the safety of their working environment. I would also like to thank Jeremiah Dirnberger, an alumnus of UIUC, for laying the groundwork for me to think about the application of lean production methods to railway operations, and for his valuable feedback regarding my research. Thanks also to Tom Guins from the Transportation Technology Center, Inc. (TTCI) for his assistance and feedback regarding my economic analysis and to Eric Wilson and others at Berkeley Simulation Software for the use of Rail Traffic Controller (RTC). Finally, thanks to Monique Stewart from the FRA for her valuable feedback on this project.

In addition, there are many people at the University of Illinois who are greatly deserving of recognition and thanks. First and foremost, I am grateful to Riley Edwards and Professor Chris Barkan for the leadership and direction they provided as my graduate advisors. Thanks to Riley for teaching me to remain on the critical path and think directionally and for providing an example for me to look up to, both at work and in life. Thanks to Chris for challenging me to

pursue excellence and quality and for teaching me how to think critically, write technically, and value scientific curiosity. I would like to thank them both for the confidence they placed in me as an undergraduate and for inspiring me to pursue a future in railroad engineering. I would also like to thank Mark Dingler for the time he spent running simulations and providing technical insight regarding RTC and the train delay analysis. Thanks to Chaz Gross, Mike Wnek and Brennan Caughron from UIUC for assisting me at various stages of my master's research. Thanks to John Hart, Esther Resendiz and others in the Computer Vision and Robotics Laboratory for their efforts and assistance with the AISC project. Thanks also to all the other graduate students in the Railroad Engineering Program and to the students of the AREMA Student Chapter at UIUC for making all the work worthwhile.

Finally, I would like to thank the other people in my life who have contributed to this story in personal ways. Words cannot express the gratitude I have towards my parents, Tad and Diane Schlake, for their constant support, unconditional love, and for encouraging me every step of the way. Thanks to my brother, Jeremy Schlake, for his brotherly love and support and for teaching me not to take myself too seriously. Thanks to my roommates during graduate school, Johnson Samuel and Josh Weakly, for their encouragement and patience. I would like to also thank my high school English teacher, Jim Heup at Naperville Central High School, for helping me develop writing skills in preparation for college and for inspiring me to be a better writer. Last of all, I would like to thank the person who knew my story before it was ever written, my Lord and Savior Jesus Christ. I am thankful for the strength, guidance, wisdom and eternal hope He provides me each day of my life.

TABLE OF CONTENTS

CHAPTER 1: INTRODUCTION.....1

CHAPTER 2: ROLLING STOCK SAFETY.....11

CHAPTER 3: CURRENT RAILCAR INSPECTION PRACTICES.....30

CHAPTER 4: AUTOMATED CONDITION MONITORING TECHNOLOGY.....46

CHAPTER 5: TERMINAL EFFICIENCY.....57

CHAPTER 6: MAINLINE EFFICIENCY.....77

**CHAPTER 7: MACHINE VISION CONDITION MONITORING OF HEAVY-AXLE
LOAD RAILCAR STRUCTURAL UNDERFRAME COMPONENTS.....97**

CHAPTER 8: CONCLUSIONS AND FUTURE RESEARCH.....124

REFERENCES.....129

CHAPTER 1: INTRODUCTION

1.1 Purpose

The purpose of this research was to determine the safety and economic implications of using Automated Condition Monitoring Technology (ACMT) to augment manual freight car inspection practices.

1.2 Motivation and Background

Over the last three decades the railroad industry has made substantial efforts to improve safety and efficiency. Since 1980, train accident rates have declined by 75 percent and employee injury rates have declined by 82 percent (Figure 1.1a) (AAR 2010). As a result, the railroad industry has become one of the safest industries in the United States, achieving record minimum train accident and employee injury rates in 2009 (AAR 2010). One might expect that these improvements to safety would have come at the expense of employee productivity: “Given resources and the state of technology, firms face a trade-off between safety and output” (Aldrich 2006). However, throughout the history of the railroad industry, the development, adoption and implementation of new technologies has resulted in a shift in the relationship between safety and output, allowing both factors to be improved simultaneously.

Since the passage of the Staggers Act in 1980, economic resources have been more readily available to invest in new technology to improve railroad safety and efficiency (Gallamore 1999). This is evidenced by the fact that railroad employee productivity increased by over 400 percent from 1980 to 2009 at the same time that industry-wide safety was rapidly improving (Figure 1.1a) (AAR 2010b). Many factors contributed to the gains in safety and efficiency including advancements in design and maintenance of freight cars, locomotives, track and infrastructure, as well as improvements in data processing and communications (AAR 2009).

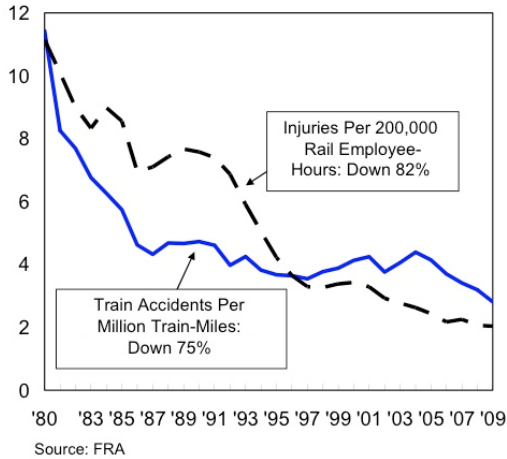

(a)

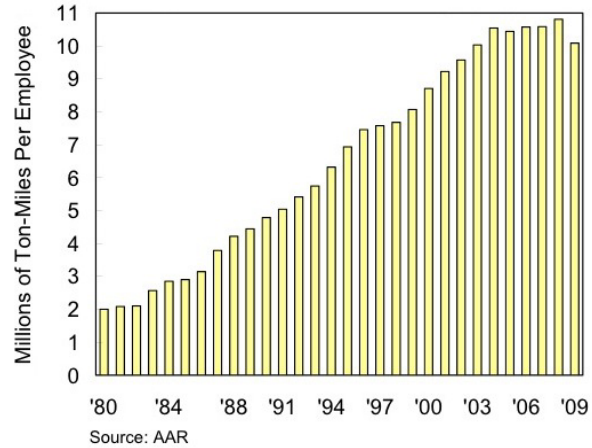

(b)

Figure 1.1 Rail Accident and Injury Rates since 1980 (a) (AAR 2010) and Railroad Employee Productivity Rates since 1980 (b) (AAR 2010b)

To maintain a high level of safety, railroads continue to make efforts both to prevent train accidents and derailments and to ensure a safe working environment for railroad personnel. The inspection and maintenance of railcars has been a major focus of safety and efficiency since the 1980s. In order to ensure the safety of the nearly 1.6 million freight cars operating in North America (AAR 2008), the United States Department of Transportation (US DOT) Federal Railroad Administration (FRA) has developed a series of regulations governing railcar inspection practices (US DOT 2008). In addition, the Association of American Railroads (AAR) maintains freight car interchange rules to improve the effectiveness of freight car maintenance practices and to protect the physical infrastructure from potential damage caused by defective railcars (AAR 2010d).

Railcar inspection has played a large role in the improvement of railroad safety, but it also has the potential to directly impact rail transportation efficiency by reducing the risk of in-service failures. Throughout this thesis, the term in-service failure (ISF) will refer to an instance where one or more defective railcar components cause a train to stop on the mainline. ISFs can result in short stoppages (i.e. 1-2 hours) during which the defective railcar is repaired along the

line-of-road or the car is set out in a siding or industry track. In more serious cases (e.g. a broken wheel or axle) an ISF can result in a derailment, causing extended mainline outages of up to 48 hours. For a capacity constrained railway network, a mainline delay of any length will have costly train delay consequences.

In order to reduce the risk of derailments and ISFs, railcar condition must be effectively monitored so that cars can be maintained using preventive maintenance strategies. If the condition of a railroad's rolling stock is not monitored appropriately, the railroad must rely on less efficient corrective maintenance, which occurs only after a defect has developed and been detected. Condition-based maintenance (CBM), as opposed to corrective maintenance, is a form of preventive maintenance based on vehicle performance and/or parameter monitoring (Lagnebäck 2007). As a result, current railroad inspection practices have been designed to facilitate CBM: both the FRA mechanical inspection regulations and AAR interchange rules facilitate the repair of defects in their early stages. Ideally, railcars are repaired before reaching a point where they would impose imminent risk of failure. Unfortunately, the degree to which CBM can be realized depends on the effectiveness of the railcar inspection process. If an inspection does not accurately monitor a railcar's true condition, then the benefits of CBM cannot be realized.

Current railcar inspection practices require a car inspector, referred to as a carmen, to walk or ride a vehicle along the entire length of a train, visually inspecting the mechanical components on each car. Depending on the carmen's training, experience, and working conditions these inspections can be inconsistent in their objectivity and effectiveness. As a result, a train may be inspected to the best ability of a particular carmen, yet defects may be missed. To improve the effectiveness of railcar condition monitoring and take advantage of CBM, the AAR began the

Advanced Technology Safety Initiative (ATSI) and Technology Driven Train Inspection (TDTI) programs. The goal of TDTI and ATSI is to promote the develop and implementation of automated condition monitoring technologies (ACMT) designed to reduce the risk of equipment-related ISFs (Hawthorne, Wiley and Guins 2005, Tornay and Cummings 2005, and Robeda and Kalay 2008).

ACMT consists of durable wayside systems located adjacent to or directly beneath the railroad tracks. Various sensing mechanisms have been designed to collect data from passing trains in the form of force, temperature, audio, or visual-based measurements. Some systems are well established within the industry and have been used in revenue service for several decades, while other systems are still under development. The ultimate goal of TDTI is the implementation of a network of inspection sites where each component of the train will be inspected automatically in real time and critical health information for each car will be documented and made available to railroad mechanical department personnel (Robeda and Kalay 2008, Railway Age 2009).

By improving condition-monitoring effectiveness, automated systems have great potential to increase both safety and efficiency. However, these systems can be expensive to purchase, install and maintain. ACMT systems have several important operational requirements including: 1) railroad personnel to oversee the system hardware and ensure proper operation and maintenance, 2) an electronic infrastructure for storing inspection data and converting the data into useful information, and 3) a framework within railroad mechanical maintenance departments to apply the information gained from ACMT, making necessary and timely repairs. Realizing the potential benefits to railcar inspection effectiveness will not be achieved simply by purchasing and installing a stand-alone system: integrated systems must first be designed and

institutional changes adopted before the benefits of ACMT can be fully realized. Thus, before making the decision to implement ACMT systems, railroads must consider both the costs and benefits these technologies.

1.3 Objectives Driving Condition Monitoring Improvements

Improved railcar condition monitoring through the use of ACMT has the potential to improve both safety and efficiency, resulting in three potential areas of cost savings: reduced derailments, reduced terminal dwell and reduced ISFs (Figure 1.2). By reducing the number of equipment-caused derailments, railroads can recover the direct costs associated with track and equipment damages, injuries, and mainline delays. I provide an analysis of track and equipment damages and a discussion of injury costs in Chapter 2 and a brief discussion of mainline delay due to derailments in Chapter 6. Through the implementation of Lean Production methods, ACMT can facilitate improved yard efficiency, resulting in reduced labor costs (Chapter 5). Finally, ACMT can lead to improved mainline efficiency through the reduction of mainline delay from equipment-caused ISFs (Chapter 6).

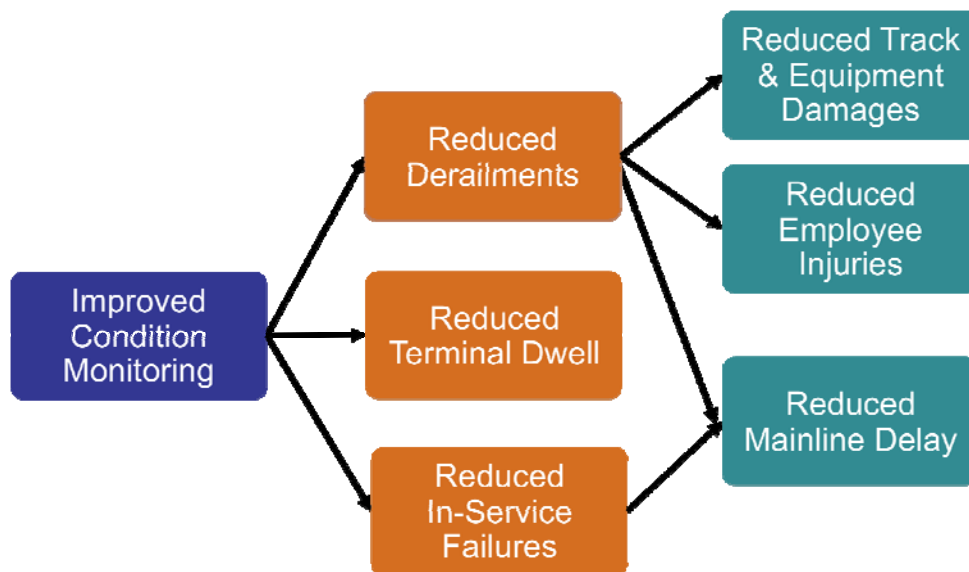

Figure 1.2 Influence Diagram Showing Economic Benefits of Improved Condition Monitoring

1.4 Thesis Organization

After a brief analysis of rolling stock safety (Chapter 2), and background discussions on current railcar inspection practices (Chapter 3) and currently available ACMT (Chapter 4), the focus of my thesis will be an analysis of the costs and benefits of improved terminal efficiency (Chapter 5) and mainline efficiency (Chapter 6) through the use of ACMT. I then describe a study performed at the University of Illinois at Urbana-Champaign (UIUC) to determine the technical feasibility of developing a machine vision freight car underbody inspection system (Chapter 7). Machine vision is an emerging area of research that has led to the development of new ACMT that will be critical to the implementation of railcar condition monitoring “super sites” capable of inspecting all safety-critical components on passing trains (Railway Age 2009). Thus, Chapter 7 serves as a case study on the technical expertise required for development of new ACMT, providing the industry with an understanding of the current status of machine vision technology. In doing so, this thesis will provide a basis for determining future research needs regarding ACMT development and implementation (Chapter 8).

This thesis is divided into eight chapters including an introduction, conclusion and six sections within the body wherein I intend to answer the following questions:

1. How is railcar condition related to railroad safety? (Chapter 2)
2. What is the current railcar inspection process and how do these inspections affect safety and efficiency? (Chapter 3)
3. What is automated condition monitoring technology (ACMT), and how will it impact railroad safety and efficiency? (Chapter 4)
4. What is the potential impact of ACMT on terminal efficiency? (Chapters 5)
5. What is the potential impact of ACMT on mainline efficiency? (Chapters 6)
6. What are the technical requirements for development of ACMT (e.g. machine vision) and how will this impact the implementation of technology in the future? (Chapter 7)

The content of these chapters mainly includes research and analyses that were presented at various technical conferences and/or submitted for publication either in conference proceedings or with a formal technical journal. The following is a brief description of each of the main body chapters.

Chapter 2: presented in part at the 2010 Joint Rail Conference (JRC) in Urbana, IL and published in the conference proceedings (Schlake et al. 2010)

This chapter addresses the impact of railcar condition on railroad safety. I include a literature review of equipment-related railroad safety from the late 19th century to the present time. I chronicle key advancements in railcar technology and safety practices that led to the reduction of train accidents and derailments as well as employee injuries. I then discuss the current magnitude of train safety costs through an analysis of the FRA accident database to determine the total cost of equipment-caused derailments. I consider accident costs due to track and equipment damages as well as car derailment rates over the period of 1999 to 2008. Employee injury and fatality rates were extremely low during this time period and the associated costs were considered to be negligible. Finally, I performed a risk-based analysis of derailment causes to determine which railcar component defects represent the greatest derailment risk. This analysis provides a basis for developing an effective approach to derailment mitigation through the implementation of ACMT.

Chapter 3:

In this chapter I discuss manual railcar inspection. I first provide a brief history of railcar inspection, followed by relevant background pertaining to the role of the FRA and AAR in

railcar inspection practices. The focus of this chapter is a detailed step-by-step description of current unit-train inspection practices on Class I railroads. This description is based on visits to a number of railroad terminals (NS, CN, CP, Belt Railway of Chicago, BNSF, Union Pacific, and CSX) between July 2008 and October 2009. Finally, I discuss the accuracy of manual railcar inspection as compared to the accuracy of ACMT.

Chapter 4:

In this chapter, I first provide a background on the development of wayside detection technologies. I then discuss the difference between reactive inspection systems and ACMT. I provide a brief survey of ACMT currently installed on US Class I railroads including a discussion of the cost of implementation. The cost of individual ACMT systems is provided in addition to the total investment in ACMT by the US railroad industry from 1993 to 2008. Finally, I provide preliminary discussions on the potential impacts of ACMT on safety and efficiency.

Chapter 5: *presented at the AREMA 2010 Annual Conference in Orlando, FL and published in the conference proceedings (Schlake et al. 2010b)*

In this chapter, I apply Lean Production methods to the railcar maintenance process and investigate potential means of eliminating waste and reducing variability through the implementation of ACMT. I consider the potential impact on intermediate 1,000-mile unit-train inspections and quantify the direct and indirect delay costs resulting from railcar inspection. This analysis provides a basis for developing cost-effective inspection and maintenance

strategies using automated technologies and evaluates potential benefits in terms of improved efficiency and increased capacity.

Chapter 6: presented in part at the 2010 JRC in Urbana, IL (Schlake et al. 2010) and the American Society of Mechanical Engineers (ASME) Rail Transportation Division (RTD) Fall 2010 Conference in Roanoke, VA, and submitted to the Transportation Research Record: Journal of the Transportation Research Board, Transportation Research Board of the National Academies in August of 2010 (Schlake et al. 2010c)

This chapter addresses the impact of railcar condition monitoring on railroad mainline efficiency. I analyze results from dispatch simulation software to determine the impact of in-service failures (ISFs) on mainline efficiency at varying traffic levels. This analysis is used to estimate the train delay cost resulting from different lengths of equipment-related ISFs on both single-track and double-track routes. Train delay is calculated by adding the primary delay (for the train containing a mechanical defect) and the secondary delay (for other trains in the network that incur delay due to the stoppage of the defective train). Variability in train delay is also considered, as it is a fundamental source of operational waste. This analysis provides a basis for the comparison of current railcar inspection practices with new integrated practices incorporating automated railcar condition monitoring systems.

Chapter 7: Currently in press in the Proceedings of the Institution of Mechanical Engineers, Part F: Journal of Rail and Rapid Transit (JRRT) (Schlake et al. 2010d). With the exception of the acknowledgements and references sections, the journal article is provided in its entirety including contributions by other authors. The article was adjusted to meet the formatting

requirements for this thesis and language was adapted from British to American English for consistency with the rest of this thesis. The abstract for this article is provided below.

To ensure the safe and efficient operation of the approximately 1.6 million freight cars (wagons) in the North American railroad network, the United States Department of Transportation (US DOT) Federal Railroad Administration (FRA) requires periodic inspection of railcars to detect structural damage and defects. Railcar structural underframe components, including the center sill, sidesills and crossbearers, are subject to fatigue cracking due to periodic and/or cyclic loading during service and other forms of damage. The current railcar inspection process is time-consuming and relies heavily on the acuity, knowledge, skill and endurance of qualified inspection personnel to detect these defects. Consequently, technologies are under development to automate critical inspection tasks to improve their efficiency and effectiveness. Research was conducted to determine the feasibility of inspecting railcar underframe components using machine vision technology. A digital video system was developed to record images of railcar underframes and computer software was developed to identify components and assess their condition. Tests of the image recording system were conducted at several railroad maintenance facilities. The images collected there were used to develop several types of machine vision algorithms to analyze images of railcar underframes and assess the condition of certain structural components. The results suggest that machine vision technology, in conjunction with other automated systems and preventive maintenance strategies, has the potential to provide comprehensive and objective information pertaining to railcar underframe component condition, thereby improving utilization of inspection and repair resources and increasing safety and network efficiency.

CHAPTER 2: ROLLING STOCK SAFETY

2.1 History of US Rolling Stock Safety

The first 80 years of United States (US) rail transportation were characterized by increasing numbers of employee fatalities and injuries. As railroads, railcars, train size and speeds increased, so did the number of people injured, maimed and killed due to railroad incidents and accidents. During the ten-year period of 1902 to 1911, over 33,000 employees and 4,000 passengers were killed and over 400,000 employees and 110,000 passengers were injured (OTA 1978). According to records kept by the Brotherhood of Locomotive Firemen and Enginemen's insurance fund, "From 1882 to 1912, 48 percent of all [member] deaths were from railroad accidents, in comparison to 7 percent from typhoid fever, the next largest cause. Outside of wartime, never before had such large groups of individuals been subject to such fearsome risks from manmade causes" (Aldrich 2006). In comparison to European railroads, US railroads assumed greater risks due to limited budgets and the desire to increase profits. The US constructed track with sharp curvature and steep grades, placing greater physical demands on rolling stock. Budget constraints also prevented US railroads from taking advantage of safer, more expensive technology. For instance, when European railroads shifted to iron wheels with steel rims, US railroads continued to use the less durable cast iron wheels with a chilled rim. Additionally, in an effort to increase profits and take advantage of the economies of scale, railroads began to increase the size of railcars, often at the expense of safety. Because of these decisions, US railroads appeared to value profit and speed over safety, and train derailments and employee injuries increased. These changes led to widespread public concern and the eventual movement toward major safety initiatives within the railroad industry.

2.1.1 Early Rolling Stock Safety

During the late 1800s, the US freight car industry experienced rapid growth. The US rolling stock fleet increased from 300,000 freight cars in 1870 to approximately 1.3 million cars by 1900 (White 1993). During this time, nominal car capacity also increased from 20,000 pounds per car to over 80,000 pounds (Wellington 1887, United States Census Office 1902). In the absence of industry-wide equipment standards, design specifications for railcar structural strength and running gear durability did not always coincide with the increases in lading capacity. In addition, the interchange of foreign cars (i.e. cars from different railroads), which had begun at a national level around 1866, presented new problems. It is estimated that by the 1880s, 40 percent of the cars on any given railroad were foreign cars (White 1993). Due to the economic structure of the interchange system, there were not always adequate incentives for railroads to repair foreign cars, which led to deferral of critical maintenance until cars reached their home railroad. In addition, because freight car designs were constantly evolving, railroad workers were faced with the challenge of inspecting and repairing new and unique rolling stock on a continual basis. As a result, railcars were often unreliable and unsafe: equipment-caused accident rates nearly doubled from 1880 to 1889 (Figure 2.1).

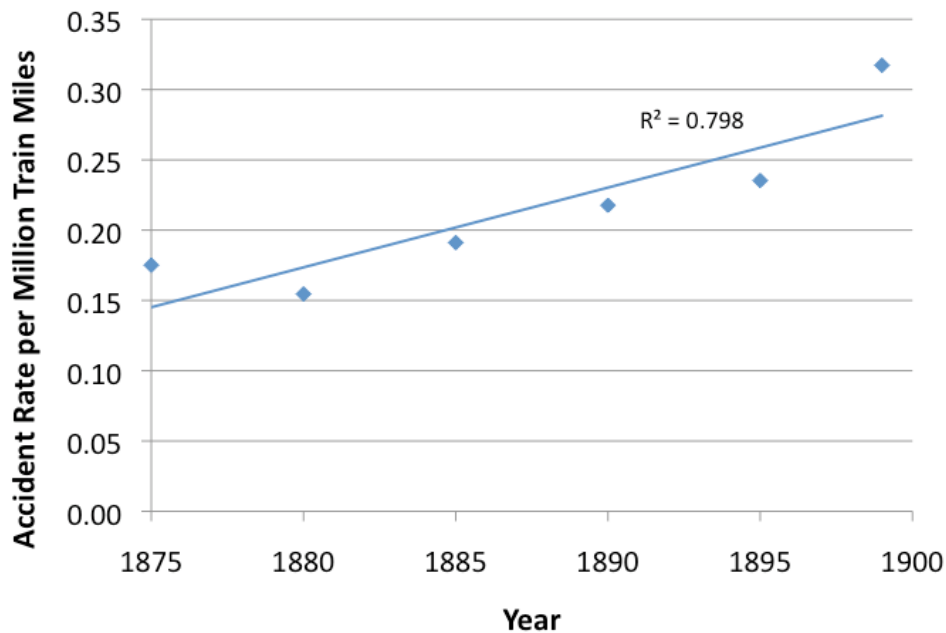

Figure 2.1 Equipment-Caused Train Accident Rates from 1875 to 1899 (Aldrich 2006)

2.1.2 *Early Railroad Employee Safety*

In addition to equipment-caused derailments, the lack of uniform and consistent equipment standards led to unsafe working conditions for railroad employees. By 1888, over 6,000 US railroad employees were being killed annually due to coupler or handbrake-related accidents alone (ICC 1889). Early freight car designs incorporated link and pin couplers, which required brakemen to work in-between moving freight cars, inserting their hand between the two couplers pockets and dropping the pin into the removable link. This operation resulted in many severe injuries to railroad employees including the loss of fingers and hands, and in some cases death. Additionally, differences in buffer block designs led to a large number of coupling deaths. Buffer blocks were a safety appliance used to protect the cars and brakemen from collision during coupling, and were located above the coupler or, in some cases, on either side of the

coupler. If the two cars being coupled had different drawbar heights or buffer block designs, the brakemen could be crushed.

In addition to coupling, train braking was another significant source of employee injuries and deaths. Early train brake technology used manual hand brakes that required members of the train crew, called brakemen, to traverse the top of a moving train and individually apply the hand brakes on each car. The lack of equipment standards impeded the work of these early brakemen, leading to thousands of injuries and deaths:

“Under the very best conditions stopping a freight train was a hazardous occupation. Under adverse ones it was almost a case of predictable injury or death. The basic problem was the lack of uniformity in freight equipment...Under these circumstances it is not too hard to understand why brakemen stumbled and fell between cars or were thrown off heavily swaying freight cars rounding curves or bouncing over rough tracks. As if this were not enough, overhead bridges added another hazard. For the men who did not get down between the cars fast enough or duck in time a bump on the head would knock them off the train” (Clark 1966).

As a result of these hazards, new technologies were developed to improve safety and prevent injuries and deaths due to train braking and coupling. Two major inventions that eventually became industry standards were the Janney automatic coupler and the Westinghouse automatic air brake.

The Janney or “knuckle” coupler allowed cars to be coupled without requiring a brakeman to stand between the cars during coupling. Despite its obvious safety benefits, the automatic coupler was not immediately adopted by the railroads. According to Wellington

(1887), the main obstacle to the introduction of the automatic coupler was its lack of reverse compatibility: “owing to the continuous interchange of cars no real benefit would be derived from such a coupler until it had come into almost universal use.” Wellington correctly predicted that complete adoption of the automatic coupler would not be achieved until the end of the 19th Century (Aldrich 2006).

Similar to the process of adopting the automatic coupler, the standardization of train braking systems was delayed despite obvious and significant safety benefits. The Westinghouse air brake system used compressed air to apply the brake shoes to the wheels of each car. With this technology, the brakemen no longer needed to traverse a moving train to individually apply the brakes on each car. However, due to initial uncertainty regarding the reliability of air brakes and the high costs required for railroads to retrofit their rolling stock, this technology was not immediately adopted by the industry. The improvement of railroad worker safety through prevention of coupler and braking accidents would ultimately require an act of Congress.

2.1.3 Early Equipment Safety Initiatives

By the end of the 19th century, public concern began to rise for equipment-related railroad safety, eventually leading the US government to implement changes within the industry. Through the advocacy of Lorenzo S. Coffin of the Iowa Railroad Commission, support from the Interstate Commerce Commission (ICC), and encouragement from President Benjamin Harrison, Congress passed the Safety Appliance Act in 1893 (ICC 1893). The Safety Appliance Act required the use of automatic couplers and air brakes as well as secure grab irons (e.g. handholds) on cars (ICC 1893, Edwards 2006). Although the implementation of standards was not immediate, statistics presented by the National Association of Railway Commissioners (NARC 1909) suggests that by the early 1900s railroad employee safety began to improve. Prior

to the Safety Appliance Act, 44 percent of all railroad employee injuries and fatalities occurred during coupling operations. Nearly fifteen years later, in 1908, that number had been reduced to only 8 percent (NARC 1909). Although an increase in injuries and fatalities due to other causes may have contributed to the decline in the percentage due to coupling accidents, this reduction is consistent with an improvement in safety due to changes resulting from the Safety Appliance Act. To better evaluate the effectiveness of early railcar and employee safety measures, the Accident Reports Act was signed into law by President William Taft in 1910 (NRHS 2006). The 1910 Accident Reports Act required railroads to report all accidents involving injury or property damage and gave the ICC authority to investigate serious railroad accidents. The framework for data collection resulting from this Act provided the groundwork for what would become the FRA Office of Safety Analysis database.

The reduction in employee injuries and fatalities that took place after the passage of the Safety Appliance Act provided motivation for the ICC to pursue additional regulation to promote railroad employee safety. As a result of safety appliance inspections by the ICC, additional railcar component defects, beyond those included in the original Act, were identified to be safety hazards. These findings led to various safety initiatives, including the passage of the Safety Appliance Act of 1910. This Act required specification of number, dimensions, location, and manner of application for ladders, roof handholds, hand brakes, running boards, and all safety appliances named in the 1893 Act (ICC 1909, Edwards 2006). To develop these specifications, the ICC created the Division of Safety Appliances in 1911 and issued orders for the application of the 1910 Act. These orders would eventually form the basis for the FRA Railroad Safety Appliance Standards.

Beyond the efforts of the government, Class I railroads also began to take responsibility

for employee safety. The Safety First program was initiated by the Chicago and North Western Railway in 1910, and by 1918, all Class I railroads were required by the government to adopt similar safety programs. As a result of these programs and the regulations of the early 1900s, employee injury rates fell by 75 percent from 1920 to 1940 (Savage 1998). Subsequent to these improvements, there were no major government enactments concerning rolling stock safety until the later half of the 20th century (Figure 2.2).

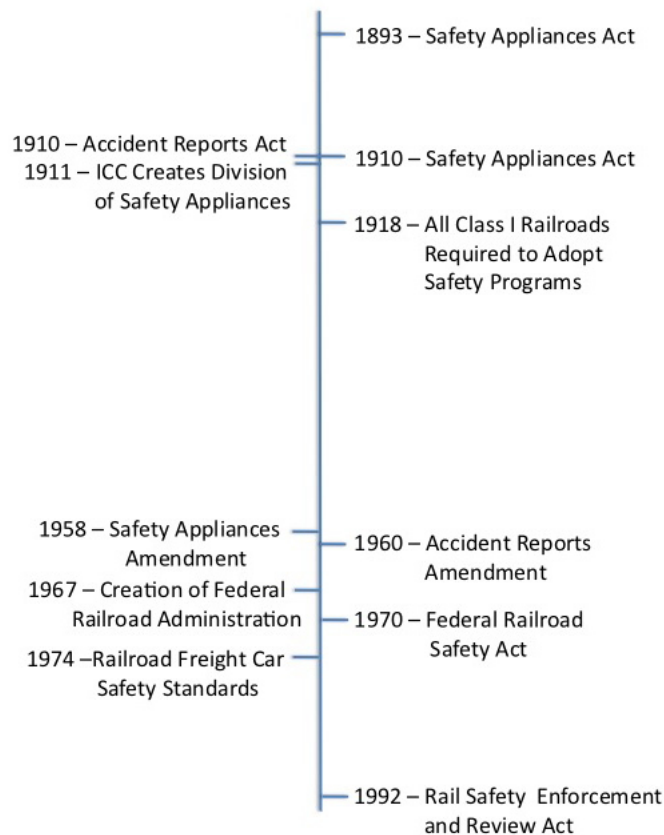

Figure 2.2 Timeline of US Government Enactments Related to Rolling Stock Safety

2.1.4 Middle 20th Century Equipment Safety Initiatives

Between 1910 and 1960 accident rates improved considerably. As a result, Congress did not pass any freight-car safety-related legislation until the 1958 amendment to the 1910 Safety Appliance Act. This amendment required the adoption of the AAR's rules for inspection,

maintenance, and testing of power brakes (OTA 1978). In 1960, an amendment to the Accident Reports Act was passed, leading to a revision of the requirements for train accident reporting. Considering the past achievements in safety, the decline in passenger service, and rapid increase in freight service, new safety regulation did not appear imminent in the 1960s. However, economic challenges and the resulting deferred maintenance of the 1960s and 1970s led to a new phase of government intervention.

The safety improvements of the first half of the 20th century regressed during the 1960s. From 1960 to 1970, railroad employee injuries and fatalities increased 75 percent and 16 percent, respectively (Savage 1998). By 1975, US Class I railroads had deferred approximately \$6.6 billion in maintenance (OTA 1978). Meanwhile, the average tons per carload had increased 43 percent from 42.5 tons in 1955 to 60.8 tons in 1975 (AAR 2008). This combination of insufficient track maintenance and increased axle loads resulted in a sharp rise in track-caused accidents. Although equipment-caused accident rates were not increasing during this time, rolling stock maintenance was still a concern of railroad managers and government regulators.

When the Federal Railroad Administration (FRA) was created in 1967, it assumed the powers of the ICC Bureau of Railroad Safety, including track and equipment regulation and inspection. One of the FRA's first initiatives was the development and issuance of the Railroad Safety Appliance Standards. Several years later, in accordance with the Federal Railroad Safety Act of 1970, the FRA issued the Railroad Freight Car Safety Standards, which went into effect on January 1, 1974. These FRA standards, and the power brake regulations which were substantially revised through the Rail Safety Enforcement and Review Act of 1992, provide regulatory guidance for all freight car inspection activities currently performed by Class I railroads.

2.1.5 Recent Equipment Safety Initiatives

In recent decades, the railroad industry has become one of the safest industries in the US, with train-accident and employee-injury rates reaching record minima in 2009. From 1980 to 2009, the number of train accidents per million train miles fell 76 percent and the number of railroad employee injuries per 200,000 employee-hours decreased 82 percent (AAR 2010). After the passage of the Staggers Act in 1980, railroad revenue rose significantly and capital funds became available for investment in infrastructure and rolling stock improvements that increased both safety and efficiency (Gallamore 1999). By the 1990s, the economic vitality of the U.S. freight railroad industry was returning. In their quest for further improvements in safety and efficiency, they began developing and investing in a variety of new technologies (Robert et al. 2009). Among these were automated condition monitoring technologies (ACMT). These technological innovations led to the beginning of a new phase of rolling stock safety by providing the capability to automatically identify freight car defects and maintain detailed records of freight car component condition. The following analysis considers the safety improvements that have occurred during the initial period of ACMT development and implementation (1990s to 2000s). This analysis also quantifies potential failure costs that may be mitigated through increased improvements to railcar inspection and maintenance practices. I provide a more detailed background and discussion of ACMT in Chapter 4.

2.2 Analysis of Equipment-Related Safety Data

Since the ICC began collecting train accident data in 1901, there have been several shifts in the federal government's interest in railroad safety. In the first half of the 20th century, the primary safety goal was the reduction of injuries and fatalities to both passengers and employees. Highway and air became the dominant modes of intercity passenger transportation in the 1950s

and 1960s. Consequently, railroad passenger injuries and fatalities declined, and attention shifted to grade-crossing safety. In addition, railroad employment declined, resulting in fewer total employee injuries and fatalities. From 1929 to 1978, railroad employment decreased by approximately 71 percent and total person-hours decreased by approximately 79 percent (OTA 1978). According to the US Office of Technology Assessment (OTA), these changes, in addition to the shift away from passenger service and toward freight transportation, led to a greater emphasis on the safety of property (e.g. track infrastructure, locomotives, freight cars and lading) as opposed to the safety of people. Rolling stock maintenance directly affects the safety of both people and property, and while large improvements have been made to the former, there still remain opportunities to improve the latter.

2.2.1 Safety of People

As a result of the safety initiatives of the early 20th century, equipment-caused injuries and fatalities are rare. During the ten-year period of 1999 to 2008, there were no equipment-caused fatalities and only 49 injuries among the four largest US Class I railroads (BNSF, CSX, NS and UP). During this same interval these four railroads accumulated approximately 4.9 billion train miles and over 3.0 billion employee hours resulting in rates of 0.010 injuries per million train mile and 0.003 injuries per 200,000 employee hours, respectively (AAR 2008b). Also of note is the fact that 22 of these injuries were due to a single derailment caused by a wheel defect in 2007. These data indicate that the safety initiatives to-date have substantially reduced the likelihood of equipment-caused accidents, and the consequent risk to human life.

2.2.2 Safety of Property

Train accidents must be reported to the FRA when a fatality or serious bodily injury occurs, or when monetary damages to track and equipment surpass a FRA-maintained threshold

(set at \$9,200 in 2009, US DOT 2009). When an FRA reportable accident occurs, railroad personnel must determine the cause of the accident and record a number of specific details regarding the circumstances of the accident. Among these are the number of cars derailed, the number of injuries and fatalities, and the number of hazardous materials cars involved in the accident. In some cases, the cause of the accident is attributed to mechanical or electrical component failure and the FRA categorizes the accident in Group E for Equipment. Over the period of 1999 to 2008, the four largest US Class I railroads had a total of 1,343 equipment-caused (Group E), mainline derailments attributed to defective railcar components. These resulted in approximately \$350 million in track and equipment damages (US DOT 2009). Analysis of these data shows a linear decrease in the number of equipment-related mainline derailments per billion freight car miles (Figure 2.3).

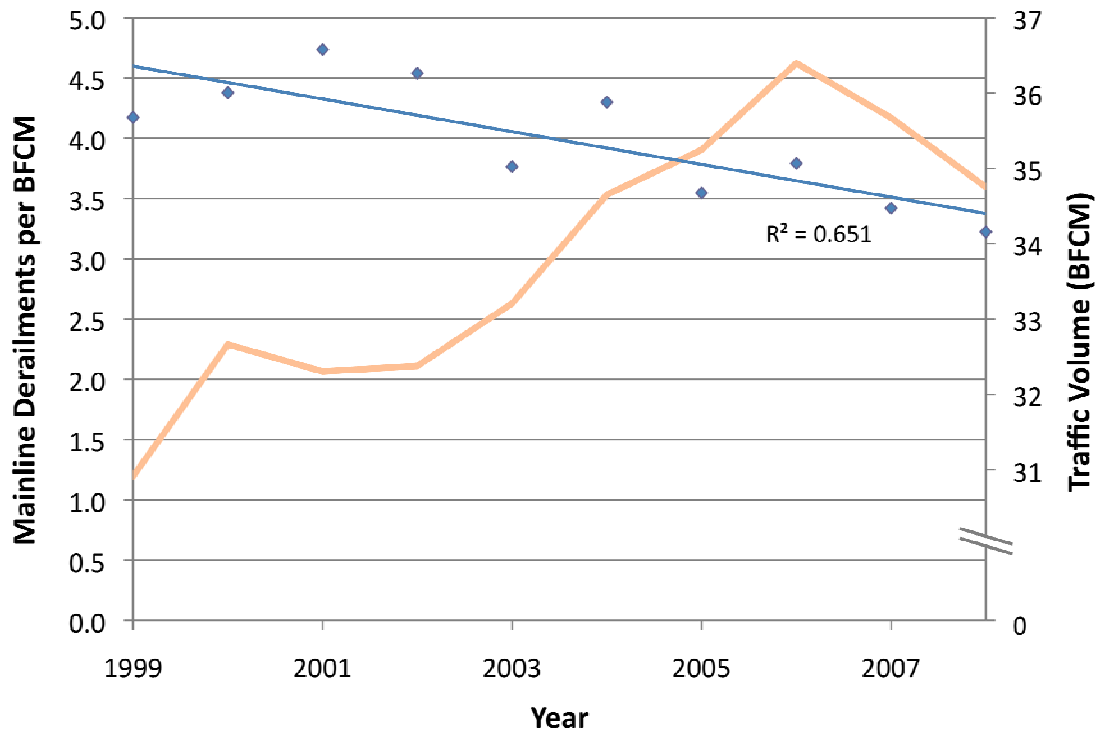
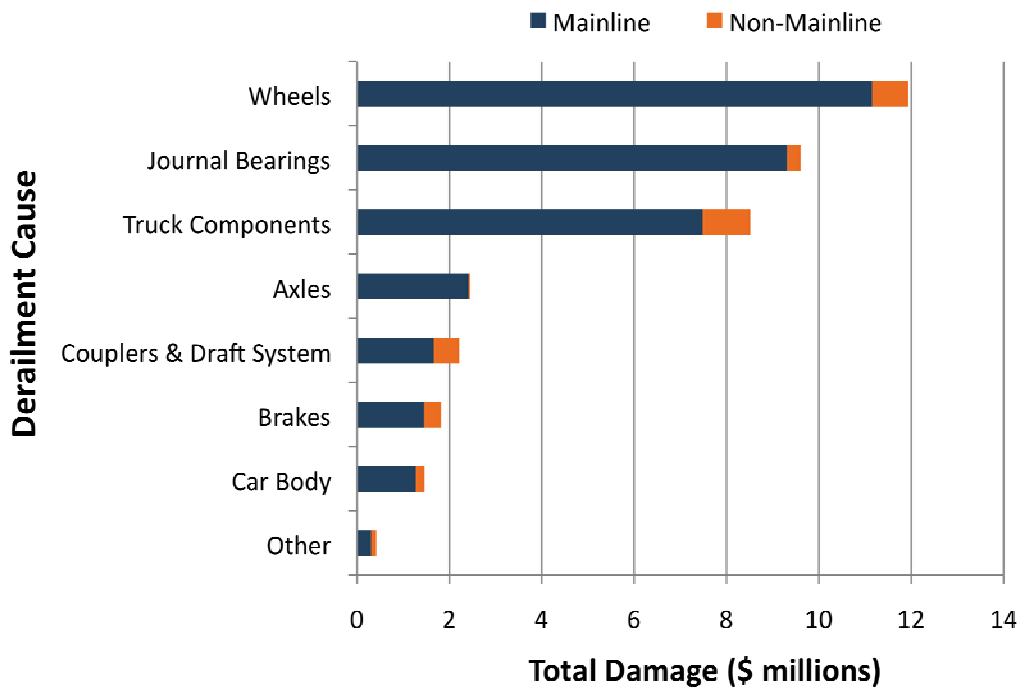

Figure 2.3 Railcar Equipment-Caused Train Accident Rates from 1999-2008 (Left Axis) Compared to Traffic Volume (Right Axis) (US DOT 2009)

While traffic volume increased from approximately 31 billion freight car miles (BFCM) in 1999 to approximately 35 BFCM in 2008, mainline derailment rates due to railcar defects declined by about one derailment per BFCM, or approximately 38 percent. This decline in derailment rates is a result of many factors, some of which may include improvements to railcar maintenance capabilities afforded by ACMT, track maintenance practices, and railcar component design. As will be discussed further in Chapter 4, North American Railroads invested heavily in ACMT during the 2000s, and as a result, the implementation of ACMT probably played a role in reducing derailment rates. An analysis conducted by Robert et al. (2009) estimated that US Class I railroads have saved approximately \$227 million through 2008 due to the implementation of ACMT. As concluded in their study:

“While the benefits of wayside detectors versus concurrent improvements in track and railcar technology and maintenance practices may be open to discussion, it is clear that there have been reductions in inflation-adjusted costs per train mile from broken wheel, broken rail, overload and imbalanced load, bearing-related, brake-related, and truck-related accidents.”

According to analysis using the FRA Accident Database, from 1999 to 2008, equipment-caused derailments resulted in an average of approximately \$38.4 million in track and equipment damages on the four largest US Class I railroads (US DOT 2009). Mainline derailments accounted for approximately \$35 million, while non-mainline derailments accounted for approximately \$3.4 million in total damages (US DOT 2009) (Figure 2.4a). Over this time period, approximately 78% of all damages resulted from three types of component failures: wheels, journal bearings, and truck components. Compared to the 10-year average, derailment costs were slightly lower in 2008 (Figure 2.4b).



(a)

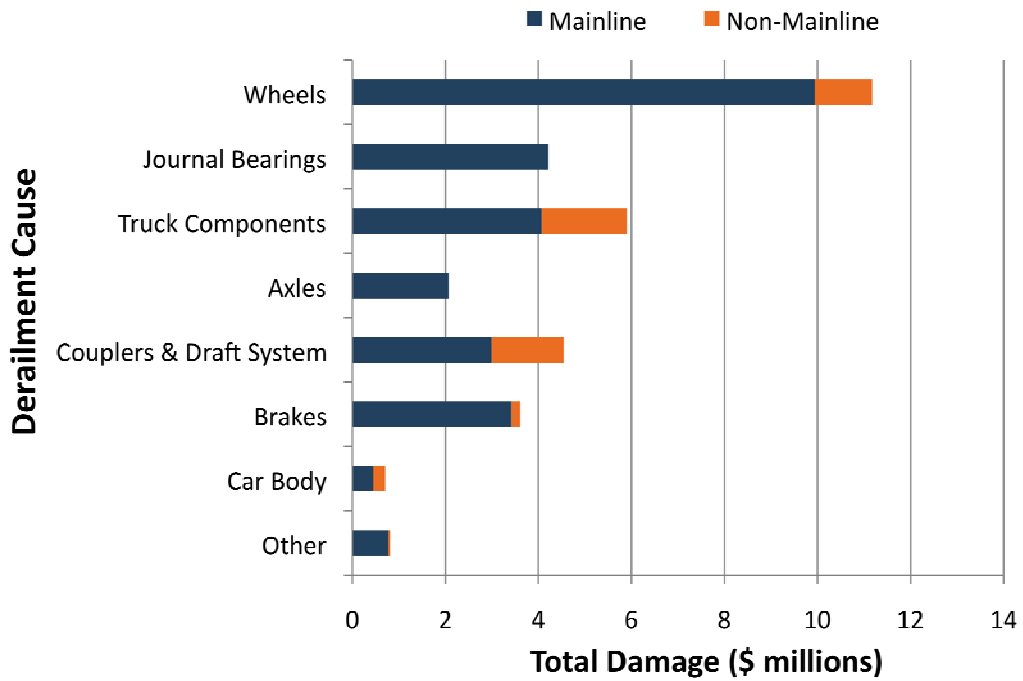

(b)

Figure 2.4 Track and Equipment Damages from Equipment-Caused Derailments; Ten-Year Annual Averages 1999-2008 (a) and 2008 Data (b) (US DOT 2009)

In 2008, the damage costs for equipment-caused derailments on the four largest US Class I railroads were approximately \$33 million (Figure 2.4b). Although costs due to wheel defects were close to the 10-year average, the costs due to defective journal bearings and truck components were much lower in 2008 than the average. These differences may be a result of improved preventive maintenance strategies aimed at reducing these types of defects.

There are key differences between mainline and non-mainline derailments. A large portion of 2008 derailments caused by defective truck components or coupler and draft system defects occurred on non-mainline track. Conversely, all axle and journal bearing-related derailments and most wheel and brake-related derailments occurred on mainline track. Since mainline track speeds are typically higher than those on non-mainline track, these data indicate that defective wheels, axles, journal bearings, and brakes may be more prone to causing derailments at higher speeds. These data also indicate that the risk associated with some railcar components may be higher than others.

2.3 Risk-Based Analysis of Mainline Derailment Causes

An analysis was performed to determine which railcar component failures pose the greatest risk of causing a derailment. Risk is often defined as the product of frequency (or probability) and consequence (Glickman and Gough 1990). Since more derailments occur on mainline tracks than non-mainlines and because repair costs and train delay costs are both higher on mainlines, the associated risk is greater. As a result, only mainline data for equipment-caused derailments were used in this analysis. Using data from 1999 to 2008 for the four largest US Class I railroads, I plotted consequence (i.e. the average number of cars derailed per derailment) versus frequency (i.e. the average number of equipment-caused derailments per year) (Figure 2.5 and Table 2.1). This analysis indicates that wheels, journal bearings and truck components

represent the causes that pose the greatest risk for equipment-caused mainline derailments. The derailment consequence for other component defects is close to the average but the frequency is lower, resulting in less risk.

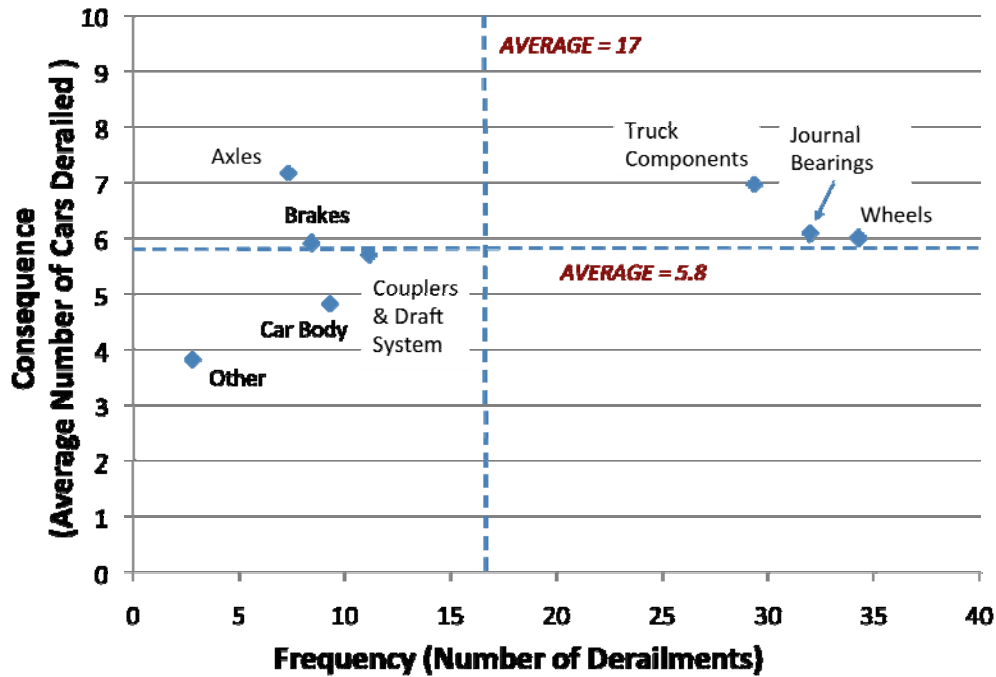

Figure 2.5 Derailment Risk Associated with Various Railcar Component Failures on Mainlines for the Four Largest US Class I Railroads, 1999-2008 (US DOT 2009)

Table 2.1 Average Annual Derailment Statistics for the Four Largest US Class I Railroads From 1999-2008 (US DOT 2009)

Derailment Cause	Number of Derailments	Cars Derailed per Derailment	Number of Cars Derailed	Cars Derailed per BFCM	Damage Costs (\$millions)
Wheels	34	6.0	205.4	6.1	11.2
Journal Bearings	32	6.1	194.1	5.8	9.3
Truck Components	29	7.0	204.0	6.1	7.5
Couplers & Draft System	11	5.7	63.4	1.9	1.7
Car Body	9	4.8	44.9	1.3	1.3
Brakes	8	5.9	49.7	1.5	1.5
Axles	7	7.2	52.2	1.5	2.4
Other	3	3.8	10.7	0.3	0.3
Total (average)	134	5.8	824.4	4.0	35.1

*BFCM = Billion Freight Car Miles

Focusing on the three mainline derailment causes representing the greatest risk, data were analyzed to determine how risk metric values have changed over time (Figure 2.6).

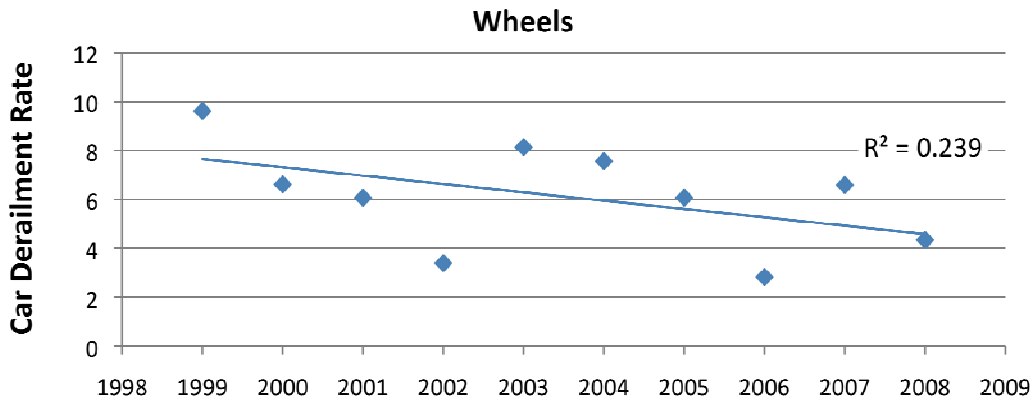

(a)

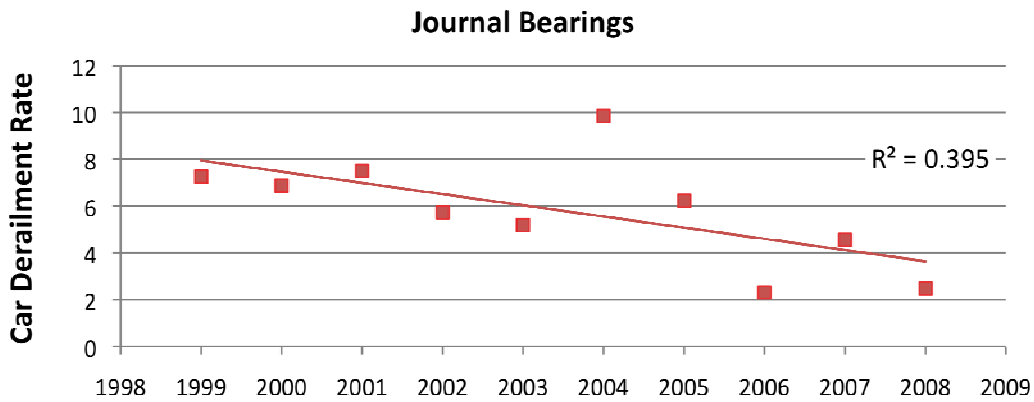

(b)

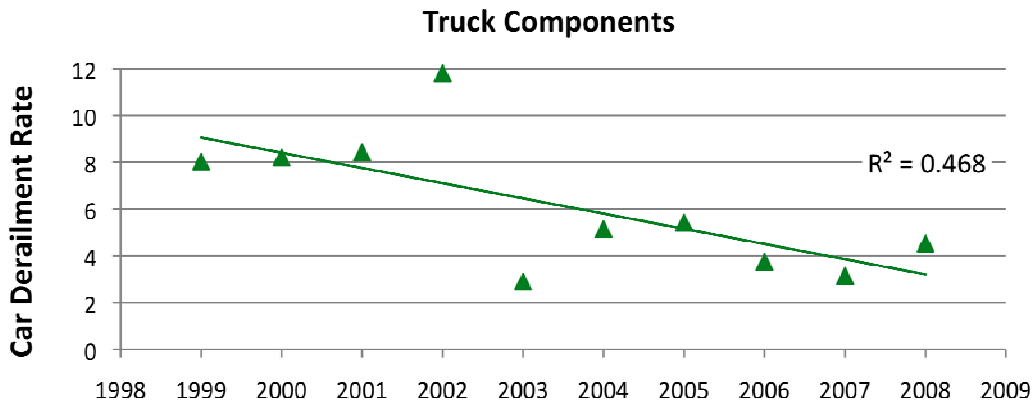

(c)

Figure 2.6 Car Derailment Rates (Per Billion Freight Car Mile) Associated with Wheel Failures (a) Journal Bearing Failures (b) and Truck Component Failures (c) for the Four Largest US Class I Railroads; 1999-2008 (US DOT 2009)

While the risk associated with wheel failures does not display a strong trend from 1999 to 2008, the linear relationships for journal bearing and truck component data are stronger. Despite exceptions in 2004 for journal bearings and in 2002 and 2003 for truck components, the data show linear decreases for both failure types over the ten-year period. These decreases in derailment risk during the 2000s may be the result of a variety of factors: new component designs and materials, improved maintenance strategies focused on preventing derailments, and new wayside detection systems designed to identify journal bearing and truck component defects. The extent to which wayside detection technology has contributed to reduced derailment risk will be discussed further in Chapter 4.

To assess the degree to which track and equipment damages can be used as a proxy for derailment risk, I compared the average annual derailment costs with the associated car derailment rates for each failure cause. Annual damage costs appear to parallel annual car derailment rates for equipment-caused mainline derailments (Figure 2.7). As shown in the previous analysis, failures involving wheels, journal bearings and truck components have the greatest consequences among equipment-caused derailments. However, since damage costs are sensitive to steel prices and other outside factors, they may be a less reliable proxy for the physical consequences of derailment risk. For the more common derailment causes (e.g. wheels, journal bearings, and truck components) the risk metrics correlate well with derailment costs. However, for the derailment causes that are less frequent, there are fewer data points, so there is greater opportunity for error.

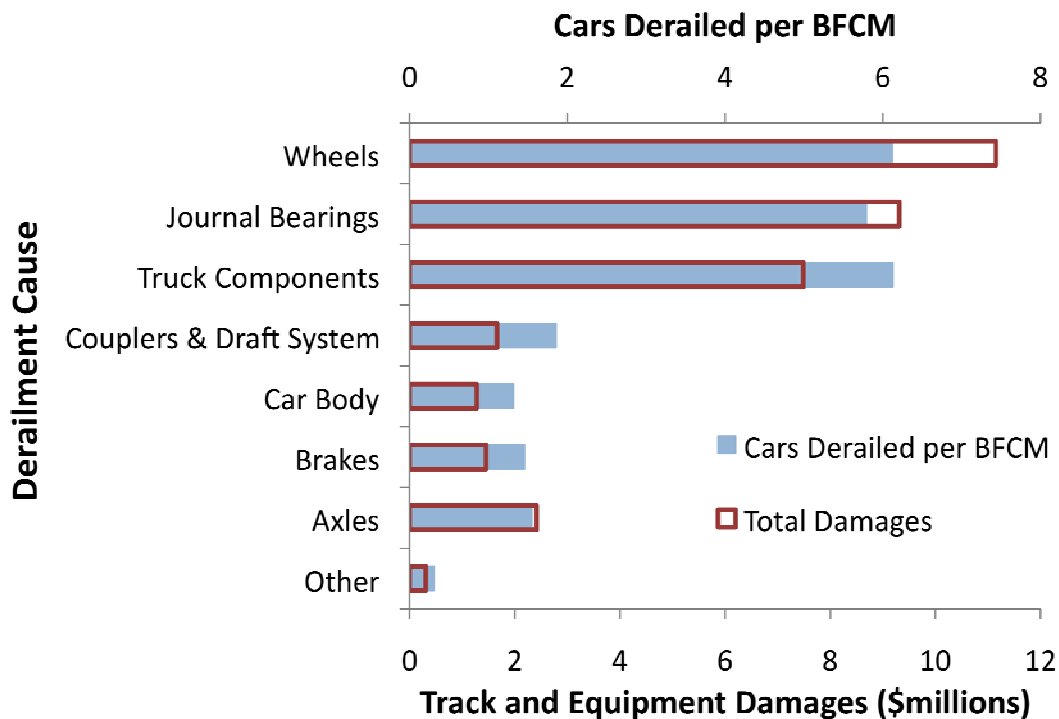

Figure 2.7 Comparison of Average Car Derailment Rates (per Billion Freight Car Mile) and Average Annual Track and Equipment-Damages for Various Derailment Causes on the Four Largest US Class I Railroads,1999-2008 (US DOT 2009)

2.4 Conclusions

Through the implementation of new technologies and maintenance practices, equipment-related railroad safety improved considerably during the 20th century. Critical advancements in federal safety legislation and regulation, railcar design, and inspection technology have led to the reduction of equipment-caused train derailments and have nearly eliminated employee injuries and fatalities due to these causes. Analysis of FRA accident data for the period 1999 to 2008 found that the four largest US Class I railroads spent an average of about \$38 million per year on equipment-caused mainline derailments. This is a conservative estimate, as it does not include environmental clean-up costs or litigation. However, this value does provide a reasonable basis to quantify the magnitude of failure costs (e.g. track and equipment damages) that may be

reduced through the safety improvements afforded by ACMT.

Among all railcar components, wheels, journal bearings and truck components represent the greatest derailment risk and result in approximately 78% of all equipment-caused derailment costs. Although car derailment rates decreased for all three types of component failure from 1999 to 2008, wheel-caused derailment rates did not decline as much as the other two causes. Thus, the greatest current potential cost savings may result from improved wheel maintenance strategies.

Given projections of increased traffic levels over the next several decades, railcar maintenance will continue to be a priority in order to realize the benefits of improved safety and efficiency. As technology and data acquisition allow for enhanced condition monitoring of railcar components, the risk of equipment-caused derailments can be further reduced. In order to realize these benefits, however, an assessment must be made of the current railcar inspection process to identify areas of potential improvement and determine the extent to which automated systems may increase inspection effectiveness.

CHAPTER 3: CURRENT RAILCAR INSPECTION PRACTICES

3.1 Railcar Inspection History

Beginning in the mid-1800s, US railroads started employing individuals for the specific purpose of railcar inspection. Although there is little historic documentation regarding the introduction of the car inspector, by 1884, the role and value of their job was well understood within the industry:

The railroads are more appreciative of his duties than in years gone by, and the best-managed roads are as careful in their appointment of car inspectors as in the selection of train dispatchers. If either makes a mistake it is irreparable and fatal (Railway Gazette 1884).

During the latter half of the 19th century, railroad technology was developing rapidly, but the service-life of railcar components was still short. As a result, equipment defects were common, placing a large burden on car inspectors. Since recommended inspection practices had not yet been developed, inspectors relied heavily on their physical ability, mental acuity and knowledge of railcar components.

To perform their duties, car inspectors relied mainly on visual inspection, but at times required the use of various pieces of equipment. Several tools of the trade included a hammer to “sound out” cracked or broken wheels, a piece of chalk or other marking device to identify cars with possible defects, and a lantern for inspecting trains at night (Railway Gazette 1884 and 1903). In 1908, to ensure that a car inspector’s experience would be retained and passed on to new employees, the American Railway Association adopted recommended practices for the selection and instruction of apprentices (Wright 1922). Although formal apprenticeship programs were eventually replaced by newer training methods, the practice of manual inspection

based primarily on experience and on-the-job training has continued to the present time.

3.2 Federal Railroad Administration (FRA) Inspection Requirements

United States Department of Transportation (US DOT) Federal Railroad Administration (FRA) regulations require that every car placed in the train must receive a mechanical inspection before the train departs from a yard or terminal (US DOT 2010). In addition, trains travelling long distances must be stopped for inspection after 1,000 miles, but are allowed to travel up to 3,500 miles between inspections if special conditions are met. When a train is initially inspected after being assembled in a classification yard or terminal, the inspection is referred to as an initial terminal, or Class I inspection, whereas 1,000-mile intermediate inspections are referred to as Class IA inspections. Each railroad has developed car inspection rules and company policies in order to comply with FRA requirements. Given that the railroad is in compliance with all FRA requirements, the specific application of the rules can vary slightly among railroads. For example, as a result of the 1,000-mile inspection requirement, some railroads have designed and constructed special inspection terminals at strategic locations along their primary corridors (e.g. the BNSF inspection terminals at Belen, NM and Alliance, NE). Regardless of the location, however, each railroad must supply the FRA with a list of all designated locations where Class IA inspections are performed.

FRA-mandated safety compliance inspection of freight cars must only be performed by persons designated by a railroad as being qualified to inspect freight cars for compliance with FRA rules and regulations (REB 1996). Car inspectors, referred to as carmen, must demonstrate proficiency in the inspection requirements given in the Code of Federal Relations (CFR) Title 49 (Transportation), Parts 215 (Railroad Freight Car Safety Standards), 231 (Railroad Safety Appliance Standards), and 232 (Brake System Safety Standards). Current FRA inspection rules

are designed to facilitate preventive maintenance by removing defective equipment prior to a derailment or in-service failure. However, based on current inspection practices, the degree to which preventive maintenance can be performed is heavily dependant on the effectiveness of car inspection personnel.

3.3 Association of American Railroad (AAR) Interchange Rules

In addition to FRA requirements, all railroads that exchange cars in unrestricted interchange must abide by the AAR Interchange Rules. These rules govern the fair and proper handling of foreign and private freight cars and apply to the inspection, repair, and disposition of such cars. Foreign freight cars are those being transported by any railroad other than the owner. Private freight cars are ones that are owned by companies other than a railroad (e.g. General Electric Railcar Services Corp., Trinity Industries Leasing Companies Inc., First Union Rail Leasing Co., GATX Rail Corp., and Union Tank Car Co.). In April of 2010, approximately 12% of cars on US Class I railroad lines were foreign and approximately 58% were privately owned (AAR 2010c). Since over 70% of the freight cars on US Class I railroads are not owned by the handling railroad, maintaining uniform standards for car inspection and repair is critical to the safety and efficiency of the US railroad system.

3.4 Class I Railroad Unit Train Inspection Practices

To develop an understanding of current railcar inspection practices, a field survey of inspection practices was conducted on multiple railroads (NS, CN, CP, Belt Railway of Chicago, BNSF, Union Pacific, and CSX) during the period of July 2008 to October 2009. The focus of this survey was the manual (FRA compliance) inspection of unit trains (i.e. those that remain as a single consist from origin to destination, often containing cars with the same type of lading). Unit trains were chosen because they represent traffic that generates among the highest total

revenues and car utilization rates (e.g. coal and intermodal). In addition, initial ACMT applications, especially machine vision technology, will be most applicable to the inspection of unit trains due to the uniformity in car design.

Although some inspection practices vary slightly among railroads or locations, the general procedure performed by car inspectors remains relatively consistent among US Class I railroads. This procedure can be divided into seven distinct steps: 1) secure track protection, 2) inspect train, 3) make necessary minor repairs and/or identify bad-order cars, 4) perform air test, 5) release brakes, 6) verify brake release, 7) remove track protection. With the exception of step 6, all of these steps apply to both Class I and Class IA inspections.

3.4.1 Secure Track Protection

When a train enters a railyard or terminal, it is typically stopped on a receiving track where the train crew sets the hand brakes on a portion of the cars and detaches the locomotive(s). Either two, or in some cases four, carmen are then assigned to inspect the train. Before approaching the train, the carmen must contact the yard office and secure track protection to ensure that the cars will not be moved or coupled to while performing the train inspection. This is referred to as obtaining “blue-flag,” or “blue-signal,” protection and requires the placement of a blue-colored marker either directly adjacent to, or in-between the gauge of the track (Figure 3.1a). To ensure complete protection, a blue-flag must be placed both in front of and behind the train being inspected. In some cases, a blue marker is also placed on the locomotive to provide an indication to the train crew that blue-flag protection has been secured (Figure 3.1b). As another measure of precaution, the inspection track is typically protected through the use of derails or by throwing switches in front and behind the stopped train. A derail is a special device that is placed on the rail to prevent rolling stock from moving beyond a specified location, and

designed to derail cars that roll over the device (Figure 3.1c). The derail shown in Figure 3.1c can be locked from outside the track (where the blue flag is located) so that carmen do not need to foul the track when locking or unlocking the derail.

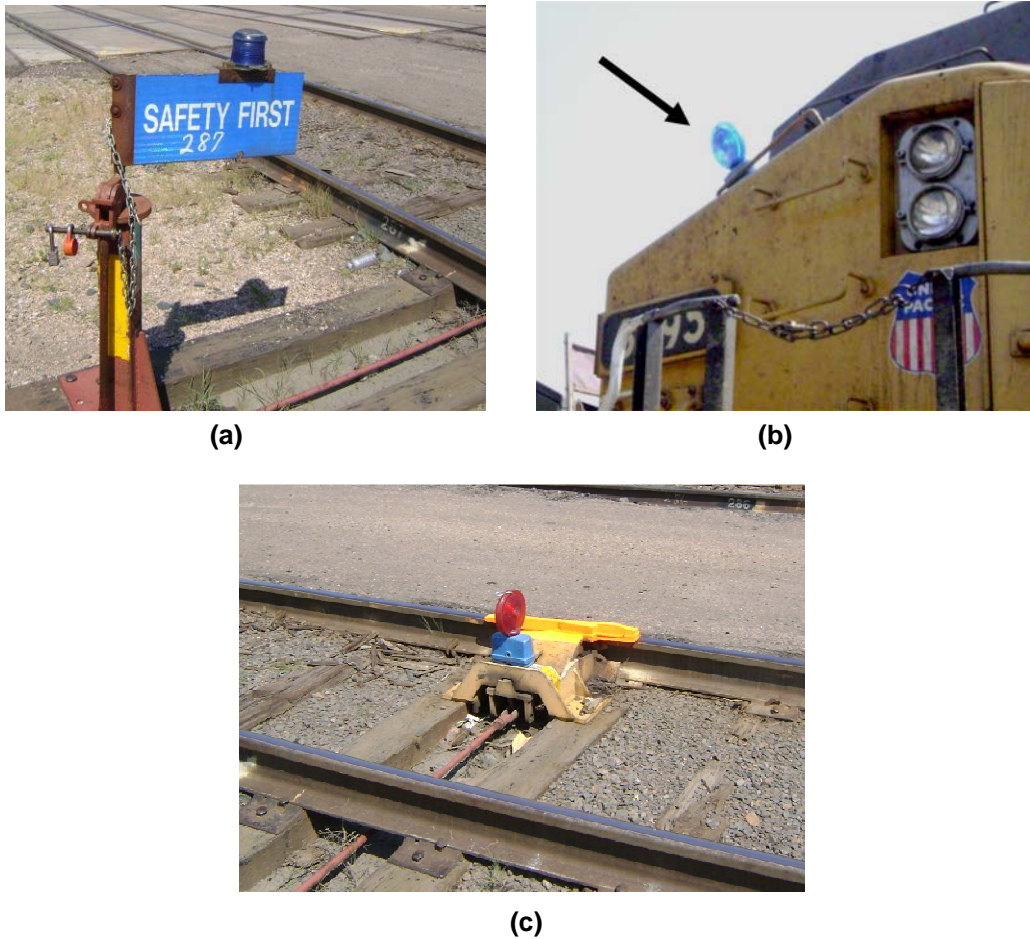

Figure 3.1 Class I Railroad Blue-Flag Protection Equipment Including Flag (a), Locomotive Marker (b), and Derail (c)

3.4.2 *Inspect Train*

Current railcar inspection practices require carmen to walk or ride a vehicle along the entire length of a train, visually inspecting the mechanical components on both sides of each car. In most cases, two carmen are assigned to each train so that one can inspect each side of the train. In this case, the two carmen can either start at different ends of the train (Yard A, Figure

3.2) or they can start on the same side and walk in parallel on either side of the train. In other instances, four carmen are assigned to a single train, each one inspecting one quarter of the cars in the train (Yard B, Figure 3.2).

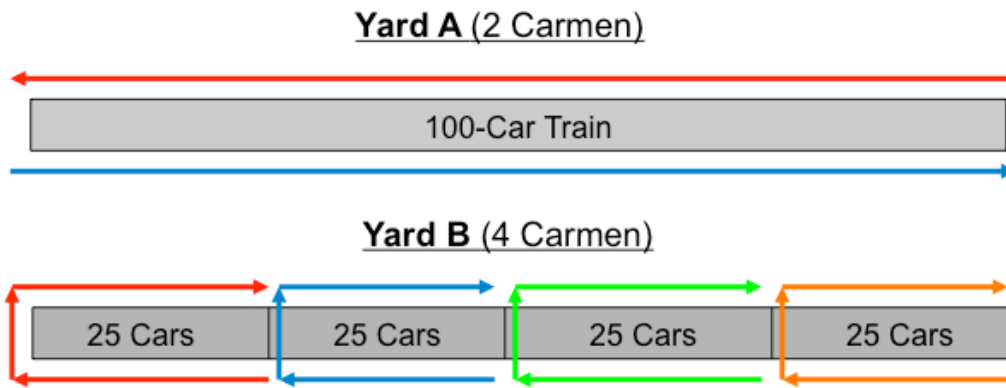

Figure 3.2 Example Inspection Arrangements for Class I Railroad Train Inspections (Edwards 2006)

Using additional carmen, as shown in Yard B, reduces the time the train is required to wait for an inspection, but the total labor time (i.e. person hours) remains constant. As a result, to avoid requiring carmen to climb in-between the cars during an inspection, Class I railroads typically use the arrangement shown for Yard A.

When performing train inspections, carmen on different railroads use various modes of transportation. For smaller yards that perform few train inspections or in yards with narrow track spacing on the inspection tracks, carmen perform inspections on foot (Figure 3.3a and 3.3b). If the track spacing allows, many railroads provide motorized vehicles for carmen to use, shown in 3.3c and 3.3e. Vehicles allow carmen to move at a faster rate and can assist in the prevention of slips, trips, and falls. In addition, repair equipment can be carried in the rear of the vehicle including tools and spare parts (e.g. brake shoes, air hoses, knuckle pins, etc.). Smaller vehicles

(Figure 3.3c) are more common, but in some cases track spacing is large enough to allow the use of full-size pickup trucks during inspections (Figure 3.3e and Figure 3.3f).



(a)



(b)



(c)



(d)



(e)



(f)

Figure 3.3 Modes of Transportation for Carmen During Train Inspections (a, c and e) and Corresponding Views from Each Mode (b, d, and f)

Using a larger vehicle can be advantageous because more equipment can be carried and carmen can perform more extensive repairs, reducing the number of cars that must be sent to a repair track or facility. During inspections, carmen operate inspection vehicles at low speeds to allow adequate inspection time and reduce the likelihood of an accident. From within the vehicle (3.3d and 3.3f), a carmen can detect major defects, such as broken and missing components. However, when a carmen identifies something that requires closer examination, they typically stop their inspection vehicle and step out to attain a better view of the potential defect.

Although most of the inspection is performed visually, carmen are sometimes required to physically handle components, to test for loose bolts, broken seals, etc. Physical contact is also necessary if a wheel appears to be worn, or defective. Using a handheld wheel gauge (Figure 3.4), carmen can determine if a wheel has a high or thin flange, a thin rim, condemnable flat spots (i.e. slid flats), or condemnable chips or gouges. AAR requirements for wheel profile limits are more restrictive than those required by the FRA. As a result, wheel gauges are used differently depending on the type of inspection and where the car is located. For example, in Figure 3.4a, the carmen is inspecting for an AAR defect, that would not apply to an FRA safety inspection.

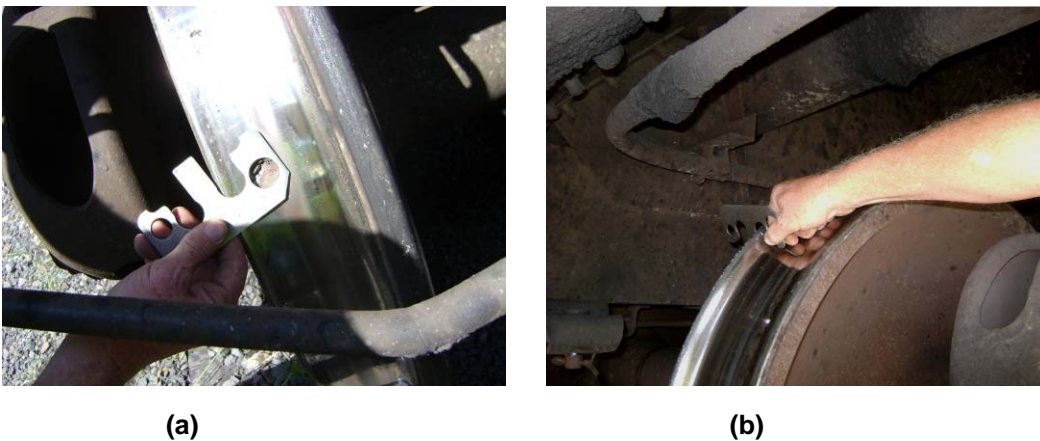

Figure 3.4 Carmen Inspecting Wheels for Shelled Tread (A) and Thin Flange (B)

According to AAR Rule 41, “Whenever any shell or spall is 1 inch or more in diameter, the wheel must be removed from service” (AAR 2010d). As shown in Figure 3.4a, the shelled spot is not yet 1 inch in diameter, so this wheel would not be condemnable under AAR rules. However, even if the shelled spot had been large enough to be condemnable under AAR rules, the wheel would not be condemnable during an FRA Class IA inspection. According to the FRA wheel inspection requirements (CFR 215.103), a single shelled spot must be more than 2.5 inches in length in order to be condemnable. There are also differences in allowable wheel profile tolerances between the AAR and FRA rules. Carmen must therefore be very familiar with the use of a wheel gauge in order to avoid mistakes. They must also be aware of the inspection requirements based on their location. Cars that have been set-out on a repair track are subject to AAR inspection rules, while on receiving tracks, or run-through tracks, only FRA inspection limits need apply.

3.4.3 Minor Repairs and Bad-Ordering Cars

In a typical car inspection, carmen may identify several cars in a train that require repair. Relatively minor defects can often be immediately rectified by the carmen using tools and supplies that are contained in their inspection vehicle. One example of a common minor repair is a worn brake shoe. Using a graduated pry-bar or other applicable tool, a carmen can easily remove and replace a worn brake shoe (Figure 3.5) in matter of a few minutes.



(a)



(b)

Figure 3.5 Wheel with Missing Brake Shoe (a) and Carmen Replacing Brake Shoe (b)

For more serious defects, if the carmen does not have the necessary replacement part or equipment to make the repair, they can either request assistance from a maintenance vehicle or “bad order” the car. Major defects that cannot be repaired on the inspection track must be bad ordered, meaning that the carmen must complete a Bad Order Card (Form-B) (Figure 3.6) and attach one to each side of the car. This card indicates that the car must be separated from the train and set-out for repair before the train leaves the yard. Common examples of bad-order defects include: wheelsets requiring replacement, broken safety appliances, a broken sidesill, or a broken center sill.

PLACED:	BAD ORDER				SPOT TO:
TIME: _____					BO _____
DATE: _____					MB _____
CAR INITIAL _____	NBR _____	TYPE _____	PLACE _____	DATE _____	
APPLIANCE AL - LADDER AS - SILL STEP AH - HAND HOLD AR - HAND RAIL/CABLE AB - RUNNING BOARD AC - CROSSOVER & STEP BRAKES BF - CUT OUT BC - CYLINDER BR - RESERVOIR BV - VALVES BP - PIPES, FITTINGS, BRKTS BB - ANGLE COCK, TRAINLINE BL - BEAM-HANGERS/SUPPORT BL - BRAKE ROD & LEVER BT - PISTON TRAVEL/NOT SET BH - HAND BRAKE BW - HAND BRAKE WHEEL BA - SLACK ADJUSTER	COUPLER CB - BODY CC - COMPONENTS (HEAD) CD - CENTER DEVICE CP - VERTICAL PIN CL - OPERATING LEVER DRAFT GEAR DY - YOKE DG - GEAR DD - CUSHION DEVICE DR - RETURN SPRING DC - CARRIER IRON DS - STRIKER	END ROOF & BODY EE - END ES - SIDE EH - HOPPER SLOPE SHEET ED - DOOR & GATE EA - TOP CHORD ANGLE ER - ROOF EC - HATCH DOME COVER EP - STAKE POCKET EM - METAL STAKE & POST FRAME FB - BOLSTER BODY FP - CENTER PLATE FO - OFF CENTER FF - FLOOR BEARER FC - CENTER SILL FS - SIDE SILL FE - END SILL	TRUCKS KH - HOT BOX KR - ROLLER BEARING KA - RB ADAPTER KO - WHEEL OUT OF ROUND KW - WHEEL SET KB - BOLSTER KF - SIDE FRAME KS - SPRING & SNUBBER KD - SIDE BRNG DEFECT KC - SIDE BRNG CLEARANCE OTHER LB - BULKHEAD DOOR RR - REFRIGERATION TA - LOAD ADJUSTMENT/SECUREMENT		
DEFECTS _____					
REPAIRED _____			INSPECTOR _____		
LOAD _____		EMPTY _____		AIR _____ ROAD _____	

Figure 3.6 Bad Order Card (Form-B) for Sample Class I Railroad (Edwards 2006)

3.4.4 Perform Air Test

An important aspect of every car inspection is the air test. For unit trains undergoing intermediate inspections, the air test occurs immediately after inspecting the mechanical components. This process is different for manifest trains since the cars in these types of trains are going to be classified at the yard they are arriving in (i.e. separated and assigned to different departing trains). As a result, these trains receive an inbound mechanical inspection to identify bad order cars prior to classification and then an outbound pre-departure inspection that includes the air test. For Class I inspections, 100% of the cars in a train must have operable brakes prior to leaving a yard or terminal. Therefore, if the carmen or repair personnel cannot repair a serious air leak on a car, that car must be bad-ordered. For Class IA inspections, only 85% of the cars must have operative and effective brakes. The FRA requirements for both tests (CFR 232.205(c)(1)) state that, “brake pipe leakage shall not exceed 5 psi per minute or air flow shall not exceed 60 cubic feet per minute” (CFM) (US DOT 2010). To meet this requirement, carmen can either perform a Leakage Test or an Air-Flow Method Test.

The Leakage Test involves charging the air brake system to the pressure at which the train will be operated (greater than 75 pounds per square inch, or psi). After making a 20-psi brake-pipe service reduction, and waiting 45-60 seconds, the brake-pipe leakage must not exceed 5 psi per minute. This test can be performed with the aid of an electronic end-of-train (EOT) device (Figure 3.7a) or using an analog gauge (Figure 3.7b).

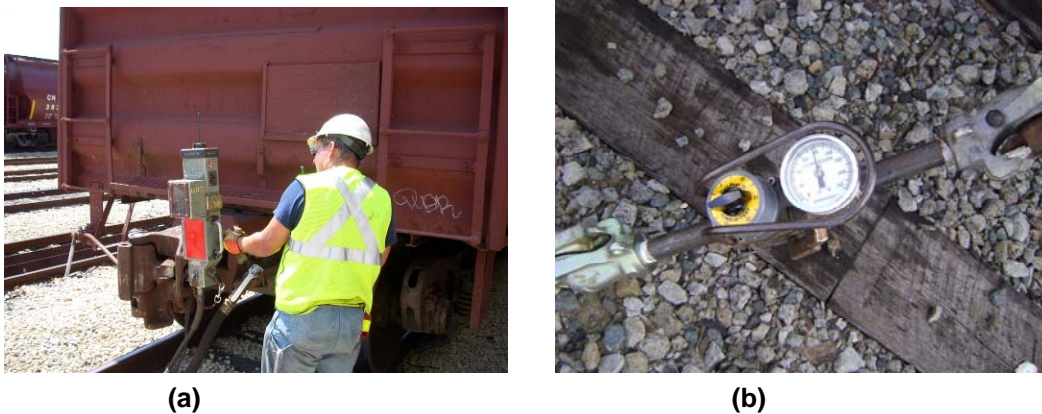

Figure 3.7 Carman Performing Brake Test (a) and Analog Brake-Pipe Gauge (b)

When using the EOT to perform the air test, the locomotive(s) must be attached at the head-end of the train and either a member of the train crew or another carman must be present in the locomotive to approve the initiation of the air test and to confirm that the test was successful. If the train fails the leakage test, the train must be charged to the pressure at which the train will be operated and carmen must examine the train for leaks and make necessary repairs or set-outs.

An alternative train line continuity test is the Air Flow Method (AFM) Test. This test can only be performed if the locomotive is equipped with a 26-L brake valve or equivalent pressure maintaining locomotive brake valve. For this test, the air brake system is charged to the pressure at which the train will be operated (and no greater than 75 psi) and the air flow is measured by a calibrated AFM indicator. To pass this test, the air flow must not exceed 60 CFM.

3.4.5 Release Brakes and Recharge

After the successful completion of the air test, the brakes are then released (i.e. the brake shoes are disengaged from the wheel treads). If a Leakage Test was performed, the brake system must be recharged to the appropriate pressure. If still attached to the head-end of the train, the locomotive(s) can be used to recharge the train. Otherwise, the cut of cars must be recharged using yard air (Figure 3.8). If a cut of cars remains off air for a period of more than four hours, FRA regulations (CFR 232.205(a)(3)) require that it must receive another Class I inspection.

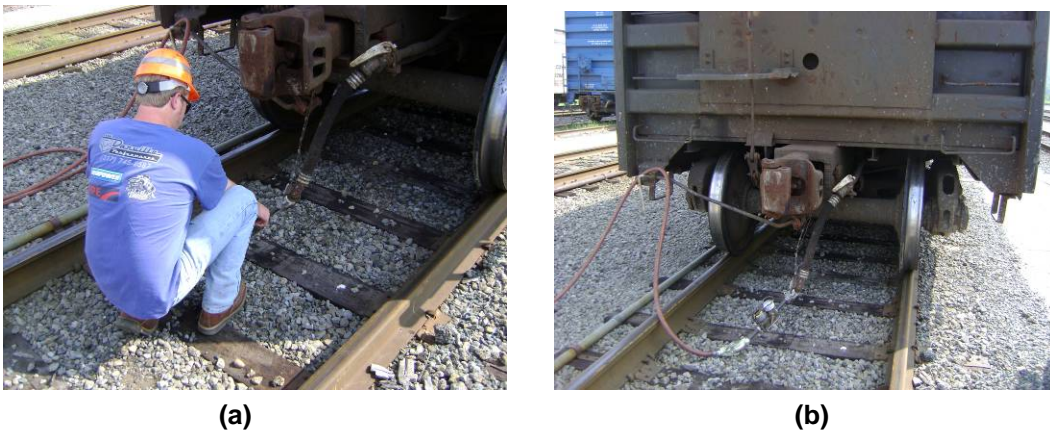

Figure 3.8 Carmen Recharging Air Brake System (a) and Yard Air Apparatus (b)

3.4.6 Verify Brake Release (Only for Class I Inspections)

If carmen are performing a Class I inspection, they must verify that the brakes have released on each car. This can be done by walking or riding a vehicle along the length of the train. When the brakes are released, the brake piston is extended (Figure 3.9a). When traveling in a vehicle, the brake piston can often be difficult to see (Figure 3.9b), so carmen must know the exact location of the brake piston on each car. As an additional means of verification, carmen also inspect the brake shoes on each car, to determine whether they have disengaged from the wheels.



Figure 3.9 Extended Brake Piston (a) and View of Piston from Inspection Vehicle (b)

An alternative method of verifying brake release is by a “roll-by” inspection. In a roll-by inspection, a qualified car inspector is positioned adjacent to the tracks and visually inspects each car as the train passes at no more than 10 mph. Although the verification of brake release is required for Class I inspections only, carmen performing Class IA inspections often verify brake release as an additional safety precaution.

3.4.7 Remove Blue-Flag Protection and Unlock Track

The final step of freight car inspection is to remove blue-flag protection and unlock and remove the derails at both ends of the train (Figure 3.10).



Figure 3.10 Carmen Removing Blue Flag Protection

If switches were used in lieu of a derail, the switch must be restored to its normal position. The switch for the track may be a considerable distance from the train, requiring the carmen to take additional time to walk or ride to the switch location. Once blue-flag protection has been removed and the track has been unlocked, the carmen notifies the train crew and yardmaster that it has passed the mechanical inspection and can depart the terminal.

3.5 Railcar Inspection Accuracy

Determining the accuracy of manual railcar inspection presents several challenges. These data have rarely been collected and field-testing may be difficult due to labor stipulations. One potential source is the FRA inspection database. FRA motive power and equipment (MP&E) inspectors make periodic visits to rail terminals to ensure that each railroad complies with FRA inspection protocol. FRA MP&E personnel often inspect trains directly after they have been inspected by railroad carmen to determine whether any mechanical defects have been overlooked. FRA inspection data from 1998-2007 indicate that FRA MP&E inspectors detected an average of 0.027 defects per car (or 1.87 defects per train) over this time period (Table 3.1).

Table 3.1 FRA Freight Car Inspection Data and Average Cars Per Train for US Railroads 1998-2007 (AAR 2009b)

Year	Cars Inspected	Defects	Defects per Car	Defects Per Train	Avg. Cars Per Train
1998	566,458	14,550	0.026	1.77	68.8
1999	606,125	15,532	0.026	1.77	69.0
2000	638,636	15,801	0.025	1.70	68.6
2001	651,841	17,966	0.028	1.89	68.5
2002	688,726	19,195	0.028	1.93	69.4
2003	643,713	18,246	0.028	1.95	68.9
2004	607,620	16,635	0.027	1.90	69.3
2005	559,764	15,464	0.028	1.90	68.9
2006	629,182	17,932	0.029	1.97	69.2
2007	675,454	18,442	0.027	1.92	70.3
Total (AVG)	6,267,519	169,763	0.027	1.87	69.1

If an inspection by an FRA MP&E inspector is assumed to be a “perfect inspection,” then an estimate for manual inspection accuracy could be determined by dividing the total number of

component defects identified by FRA MP&E inspectors by the sum of all defects identified by both FRA MP&E inspectors and railroad carmen. In other words, this is the number of defects missed by railroad carmen out of the total number of detectable defects. The inverse of this value would be equivalent to the correct identification rate for railroad carmen. Assuming that the false alarm rate for manual inspection is negligible, the correct identification rate can be considered to be equivalent to the inspection accuracy. Since inspection records are not often kept by the railroads for manual railcar inspections, there are insufficient data to determine manual inspection accuracy.

When compared to manual inspection, ACMT has the potential for higher inspection accuracies. Rail industry studies suggest that automated systems are capable of accuracies ranging between 90% and 99% (Steets and Tse 1998, Morgan 2002, Morgan and Gerald 2003). Machine vision inspection systems generally claim accuracies up to 90%, whereas WILD systems and wheel profile inspection systems have accuracies as high as 99%. These accuracy estimates have not been formally validated, however, and ACMT systems from various vendors may offer a wide range of accuracies. As this technology develops and additional data are acquired, inspection accuracies for ACMT systems will be better estimated.

CHAPTER 4: AUTOMATED CONDITION MONITORING TECHNOLOGY

4.1 Wayside Detector Background

Manual railcar inspections can vary in their efficiency and effectiveness depending on the particular experience or ability of individual car inspectors. As a result, a train may be inspected to the best ability of a particular car inspector yet defects may be missed due to limitations in their ability or the conditions of the inspection. Recognizing the inherent inefficiency and subjectivity of manual inspections, the railroad industry has developed wayside detector technologies to augment the efforts of inspection personnel. These systems, located on or adjacent to the tracks, use various sensing mechanisms to measure heat, force, sound, and visual parameters in order to monitor the condition of railcar components. Some systems are well established within the industry and have been used in revenue service for several decades, while other systems are still under development.

4.1.1 Reactive Inspection Systems

The first wayside detection systems were designed to identify defective components on passing trains in order to prevent derailments. Developed in the 1930s, 40s and 50s, these early technologies (e.g. hot bearing detectors and dragging equipment detectors) have provided a reactive means of defect detection, requiring a train to stop on the mainline if a serious defect is identified (Post 1936, 1937, Burpee 1945, Austin 1949, Gallagher and Pelino 1959, Lagnebäck 2007). Still in wide use today, hot bearing detectors (HBDs) identify overheated journal bearings using infrared sensors installed adjacent to the track (Figure 4.1a), and dragging equipment detectors (DEDs) identify low hanging equipment using a vertically positioned metal board inside the gage of the track, attached to an electronic sensor (Figure 4.1b). Both of these technologies can use a radio-based alarm to alert the train crew if a serious defect is detected.

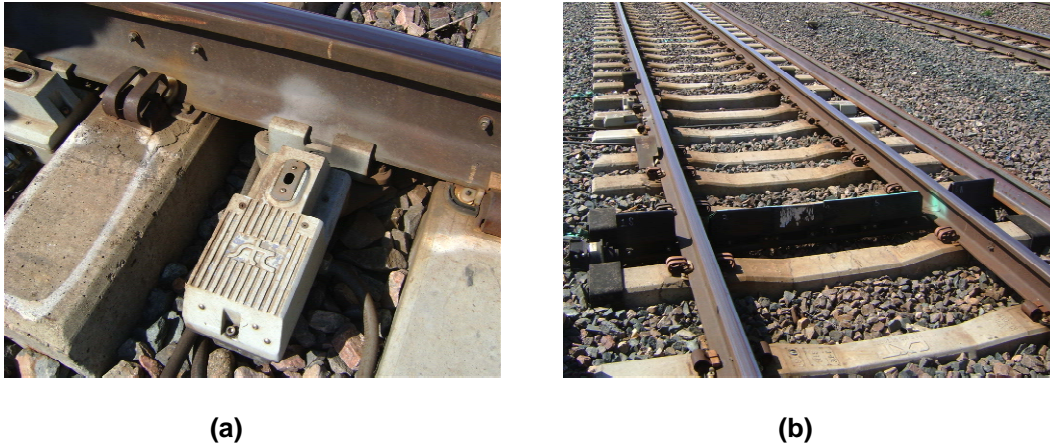

Figure 4.1 Hot Bearing Detector (HBD) (a) and Dragging Equipment Detector (DED) (b), Located on a US Class I Railroad

Although still widely used and effective in preventing derailments, these systems only provide component defect information shortly before or even after failure has occurred. Consequently, these technologies are responsible for thousands of mainline in-service failures (ISFs) each year, wherein a train must either stop on the mainline to be repaired or set out at a nearby yard or siding. Service failures due to these wayside detectors result in train delay costs and consume mainline capacity. In addition, these systems require high installation and maintenance costs. Due to the short latency between condition detection and failure occurrence, they must be installed at frequent intervals across the entire railroad network. Therefore, due to the high costs and limited predictive ability of these reactive technologies, railroads have sought the development of new railcar condition monitoring systems.

4.1.2 Automated Condition Monitoring Technology (ACMT)

Automated condition monitoring technology, referred to in this thesis as ACMT, includes wayside detection systems capable of monitoring the condition of railcar components over time in order to facilitate preventive maintenance. One example of ACMT currently used in the railroad industry is the acoustic bearing detector (ABD). Using a series of microphones adjacent

to the track, ABDs analyze the noise generated by defective roller bearings, associating specific frequency ranges with various bearing defects. Acoustic bearing detection technology was initially developed in the late 1980s to address the limitations of HBDs. However, early implementations of ABDs were unable to detect many defects, and the number of bearing related derailments remained relatively constant at approximately 50 derailments per year until the late 1990s (Cline et al. 1998). Through additional research, ABD technology improved considerably and in 2008 there were only 24 derailments due to defective journal bearings (US DOT 2009). As a result of these improvements, the AAR has validated ABD technology to be capable of detecting condemnable freight car journal bearings (AAR 2008c).

Other examples of ACMT include wheel impact load detectors (WILDs), truck performance detectors (TPDs), wheel temperature trending (WTT), truck hunting detectors (THDs), wheel profile detectors (WPDs), and machine vision. Detailed surveys of these and other wayside inspection technologies have been conducted by: Steets and Tse (1998), Bladon et al. (2004), Barke and Chiu (2005), Lagnebäck (2007), Brickle et al. (2008), and Robeda and Kalay (2008). Since derailment prevention has been the prime motivation for development of ACMT, a greater emphasis has been placed on monitoring components that are most likely to cause a derailment. As discussed in Chapter 2, FRA accident data indicate that wheels, journal bearings, and truck components represent the three categories of railcar components that are most susceptible to failure (Figure 2.6). As a result, at least ten different condition monitoring systems have been developed to address these three areas of concern. A list of these technologies, and other ACMT capable of condition monitoring, is provided in Tables 4.1 and 4.2. In addition, several of these technologies are shown in Figure 4.2.

Table 4.1 Matrix Indicating the Type of ACMT used to Address Various Mechanical-Related Accident Causes

ACMT	Accident Cause Category					
	Wheels	Axles and Journal Bearings	Truck Components	Coupler and Draft System	Brakes	Doors / Car Body
ABD		X				
ACWD	X					
AISC						X
ASAIS						X
BSM					X	
CAD		X				
FATSS*			X	X	X	X
HBD		X				
THD			X			
TPD			X			
WBT		X				
WILD	X					
WPD	X					
WTT					X	

*FATSS is still in development at TTCI

Table 4.2 Acronyms used for ACMT

Acronyms

- ABD - Acoustic Bearing Detector
- ACWD - Automated Cracked Wheel Detection
- AISC - Automated Inspection of Structural Components
- ASAIS - Automated Safety Appliance Inspection System
- BSM - Brake Shoe Module
- CAD - Cracked Axle Detector
- FATSS - Fully Automated Train Scanning System
- HBD - Hot Bearing Detector
- THD - Truck Hunting Detector
- TPD - Truck Performance Detector
- WBT - Warm Bearing Trending
- WILD - Wheel Impact Load Detector
- WPD - Wheel Profile Detector
- WTT - Wheel Temperature Trending

Three of the systems in Table 4.1 use machine vision technology, which will be discussed in greater detail in Chapter 5. These systems include Automated Inspection of Structural Components (AISC), Automated Safety Appliance Inspection System (ASAIS) and the Fully Automated Train Scanning System (FATSS), still in development at TTCI (Figure 4.2d).



(a)



(b)



(c)

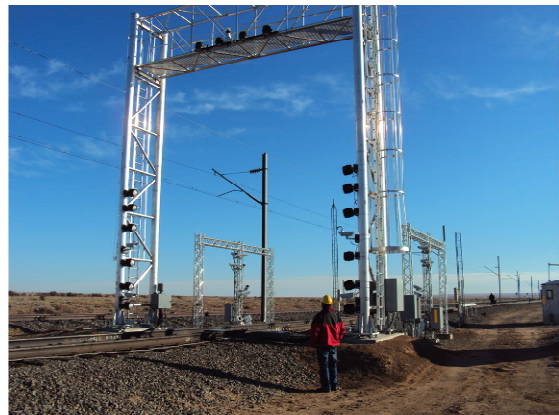

(d)

Figure 4.2 Examples of ACMT Including ABD (a), WILD (b), WPD (c), and FATSS (d)

The goal of ACMT is to facilitate condition-based maintenance (CBM). Through the implementation of CBM the physical condition of railcar components is monitored over time, allowing for trending analysis, early detection of deteriorating components, and the ability to predict component life. By identifying railcar defects and performing maintenance prior to component failure, railroads can reduce the likelihood of equipment-caused derailments and ISFs and take advantage of lower cost, predictive maintenance strategies.

The wheel impact load thresholds for WILD systems provide a basis for understanding how ACMT can facilitate CBM. Wheelsets that deliver a vertical impact force on the rail surpassing 90 kips (thousand pounds) are condemnable per the AAR interchange rules and must be replaced. However, in order to take advantage of CBM, the AAR permits opportunistic repairs to be made to wheelsets in the 80-90 kip range. Presently, this rule applies only to railcars that have already been set out in a repair track due to another defect, but these guidelines are still effective in enabling defective wheelsets to be removed from service before the wheelset degrades further. These measures serve to reduce the risk of broken-wheel derailments, deterioration of the track infrastructure, and wheel-related mainline in-service failures. Like WILDs, each ACMT system uses specific component condition thresholds that allow railroad mechanical personnel to identify railcars that are in danger of causing a derailment or in-service failure. For most ACMT, with the exception of WILDs and ABDs, further testing is still required before the AAR will adopt the system thresholds into the standard maintenance practices of the railcar interchange rules.

4.2 Current Status of ACMT Development

In the early 2000s, in order to take better advantage of ACMT the AAR developed the Advanced Technology Safety Initiative (ATSI) and Technology Driven Train Inspection (TDTI) programs. Both TDTI and ATSI promote the development of ACMT with the ultimate vision of implementing a network of inspection “super sites” where each component of the train will be inspected automatically in real time and critical health information for each car will be documented and made available to railroad mechanical department personnel (Robeda and Kalay 2008, Railway Age 2009).

The following list of automated condition monitoring / inspection systems summarizes

the number of each type that have been deployed in revenue service across the US Class I railroad network as of 2010 (Tournay and Stahura 2010):

- 130 WILDs to identify high wheel impact forces caused by flat and/or out-of-round wheels
- 30 truck steering performance systems (THDs and TPDs) to identify defective truck components and wheelsets
- 25 ABDs and approximately 6,000 HBDs to identify overheated or defective journal bearings
- 10 WPDs to identify wheels containing worn flange, tread, or rim
- 700 hot/cold wheel detectors used for wheel temperature trending (WTT) to detect stuck or inoperative brakes
- 6,000 DEDs to detect low hanging equipment or foreign objects underneath the train
- 3 systems for inspecting brake shoe thickness
- 2 automated safety appliance inspection systems (AS AIS)
- 1 automated cracked wheel detection system (ACWD)

All of these systems can be interfaced with TTCI's Integrated Railway Remote Information Service (*InteRRIS*®), an internet database used to automatically store and analyze railroad vehicle performance data (Tournay and Stahura 2010). Using industry standards and performance criteria specified by the customer, *InteRRIS*® can automatically issue notifications using e-mail or a direct data feed (McGuire et al. 2007). In this way, railroad managers and private car owners can have immediate access to critical information pertaining to the condition of their freight car fleet. This information, when used at yards and terminals to coordinate inspection and maintenance activity, provides the means necessary for implementing CBM.

4.3 Cost of ACMT

Robert et al. (2009) conducted an analysis investigating the economic viability of research, development, and implementation of ACMT. This study estimated that the net present value (NPV) of the benefit from reduced derailments and other accidents attributable to wayside detection was approximately \$335 million through 2008. Data from this analysis also show the sizeable increase in ACMT investment made by US Class I railroads during the 1990s and 2000s (Figure 4.3). The costs shown in Figure 4.3 include installation, system maintenance, IT costs, and *InteRRIS*® fees for: WILDs, ABDs, TPDs, HWDs, CWDs, THDs, and WPDs.

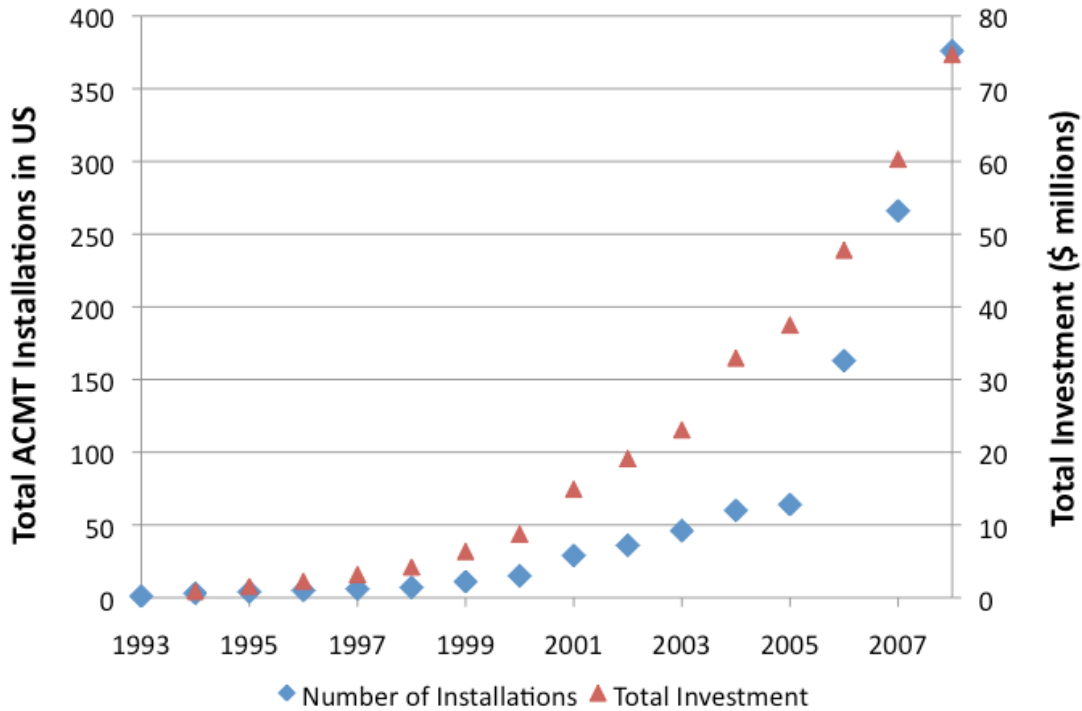

Figure 4.3 ACMT Installation and Railroad Investment from 1993 through 2008 (Robert et al. 2009)

The cost of installation and maintenance varies for each system. For example, installation costs, per detector, can range from \$300,000 for an ABD or \$600,000 for a WILD to over \$1 million for a WPD (Robert et al. 2009). Annual maintenance costs have been estimated

at \$12,500 for ABDs and WILDs and \$20,000 for WPDs (Robert et al. 2009). From 1990 to 2008, US Class I railroads invested a total of \$120 million for wayside detector equipment installation, operation, maintenance and research (Robert et al. 2009). Of this total, approximately \$75 million was invested in ACMT (Figure 4.3).

In addition to these costs, the implementation of ACMT has resulted in other subsequent costs to the railroads. Since ACMT allows improved condition monitoring, implementation of these systems has led to increased railcar maintenance costs. For example, over \$22 million was spent from 1990 to 2008 on increased wheelset replacements. Other costs that can accompany the implementation of ACMT affect train operations. For example, when a WILD identifies a wheel impact load above a certain threshold (e.g. 170 kips) the train must be stopped immediately. However, since ACMT facilitates CBM, detector stops caused by these technologies occur less frequently than with reactive technologies such as HBDs or DEDs. As a result, the costs to train operations associated with ACMT should be minimal. Finally, as railcar condition information has become more readily available, railroads have begun to implement new maintenance practices such as creating railcar condition reports for incoming trains to assist car inspectors during inbound inspections. The cost of these institutional changes, although difficult to quantify, can come in the form of education, training, and development of new policies and procedures associated with technology integration.

4.4 Potential Impact of ACMT on Safety

To determine the potential reduction in damage costs due to ACMT, the effectiveness of railcar condition monitoring must be determined. Improved condition monitoring effectiveness will reduce the likelihood of equipment-caused derailments, resulting in fewer injuries and fatalities and reduced track, equipment, and property damages. In addition, preventive

maintenance afforded by ACMT will reduce infrastructure damage caused by defective railcar components. The extent to which ACMT increases condition monitoring effectiveness will depend on the net difference in accuracy between manual and automated inspection systems. Unfortunately, determining inspection accuracy is nontrivial for several reasons. There are few accurate data sources for determining manual inspection accuracy and the accuracy of many ACMT systems has not been validated yet because many of these systems have not been in field operation for a sufficient amount of time. As a result, researchers have relied on empirical data and retroactive analysis (e.g. post-audits) to determine the cost benefits of ACMT.

Another challenge to determining the potential safety benefit of ACMT is that some inspection tasks have not yet been automated. Railcar defects affecting the wheels, truck components, axles, journal bearings, brakes, and some carbody components can all be monitored – at least in part – using currently available ACMT (Lundgren and Killian 2005, Tournay and Cummings 2005, McGuire et al. 2007, Robeda and Kalay 2008, Railway Age 2009). However, defective couplers, draft systems, and doors are not yet being monitored using current technology. Machine vision systems will likely be developed to address the inspection of these components, however these systems are still at various levels of development and are not yet available for commercial use. Further technological advancements in ACMT will therefore be required to gain the full benefit of automated railcar condition monitoring.

4.5 Potential Impact of ACMT on Efficiency

The cost savings due to reduced derailments and infrastructure damage have been the prime motivation for development of ACMT, but there are also considerable cost savings resulting from improved operational efficiency. Strategic integration of ACMT can reduce the time needed for railcar inspections. As a result, trains can be processed more quickly through a

yard or terminal and repairs can be scheduled more efficiently. Through CBM, railroads can reduce the opportunity cost associated with bad ordering a car by scheduling repairs in such a way that multiple components on the car are repaired at the same time. Other direct and indirect cost savings for yard operations resulting from automated railcar inspections will be discussed further in Chapter 5. In addition to improved terminal performance, the increased inspection effectiveness afforded by ACMT will result in improved mainline efficiency. As ACMT allows railcar maintenance personnel to remove or repair defective railcar components before failures occurs, railroads will benefit from fewer equipment-related mainline in-service failures. As will be discussed in Chapter 6, this can result in reduced train delay and increased mainline capacity, leading to substantial cost savings for the railroad industry.

CHAPTER 5: TERMINAL EFFICIENCY

5.1 Background and Motivation

As early as 1925, the railway terminal was identified to be a major source of lost productivity in freight operations (Droege 1925). By the 1960s, terminal efficiency had become a major focus in railroad engineering research (RSMA 1967). As railway terminal research continued during the latter half of the 20th century, management techniques were also evolving in other industries to improve production and manufacturing efficiency. In the 2000s, various production management techniques were applied to terminal operations through the introduction of Lean Railroading (Dirnberger 2006, Dirnberger and Barkan 2007). Lean Railroading offers an approach to eliminate operational waste by improving the overall capacity, efficiency and asset utilization of a railroad terminal. As railroads continue to take advantage of newly available technologies and management strategies, principles from Lean Railroading can be applied to individual aspects of terminal operations, including railcar inspection and maintenance practices to further improve efficiency.

5.1.1 Terminal Performance

Yards and terminals have a sizeable impact on railroad productivity and reliability. In regards to general manifest traffic, Murray (2002) states that, “Cars spend most of their time in terminals, and that’s where the service battle is won or lost for carload business.” Dirnberger cites several reports stating that as much as 64% of railcar transit time is spent in yards (Dirnberger 2006, Dirnberger and Barkan 2007). A common metric used to describe this time spent in yards is terminal dwell, which is measured in hours and is defined as the average time a car resides at a specified terminal location (AAR 2010c). Dirnberger noted the relationship between terminal dwell and train velocity, concluding that average train speed decreases linearly

with increased terminal dwell (Dirnberger 2006, Dirnberger and Barkan 2007). Average train speed, calculated by dividing train-miles by the total hours of train operation (AAR 2010c), is often used as a proxy for railroad performance. An estimation by Logan suggested that for every 15% reduction in systemwide average terminal dwell, there would be an increase of 2 mph in the average train speed for carload traffic (Dirnberger 2006, Logan 2006). In May 2010, US Class I railroads had an average train speed of approximately 25 mph and a systemwide average terminal dwell of approximately 22.5 hours (AAR 2010c). Although the exact relationship between terminal dwell and train speed varies among different railroads, reducing the former will almost always lead to an increase in the latter.

5.1.2 Lean Railroading

The concept of Lean Railroading was developed during the 2000s as an approach to improve efficiency in classification yards. According to Dirnberger, “Because classification terminals can be considered production systems, their performance can be improved by adapting an integrated approach consisting of three proven production management techniques: lean, theory of constraints (TOC), and statistical process control (SPC or Six Sigma)” (Dirnberger 2006, Dirnberger and Barkan 2007). In this analysis, I focus only on the concept of lean production, as it has been applied to railroad terminal operations, in the form of Lean Railroading.

In 1990, the term “Lean Manufacturing” was first introduced in a study at Massachusetts Institute of Technology (MIT). That study concluded that Toyota production techniques were superior to other competitors in the automotive manufacturing industry (Womack et al. 1990). These findings helped launch the use of lean methodology and other principles, first implemented by Toyota, that have been adopted by numerous companies throughout the world

(Womack and Jones 2003). Although similar principles had previously been used in railroad terminals, the first formal application of lean techniques occurred in the 2000s by Dirnberger and the Canadian Pacific Railway (CPR) Yard Operations Performance Group.

Lean is defined as the production of goods or services using minimal buffering costs (Hopp and Spearman 2004). Sources of excessive buffering include both direct waste and variability. Direct waste is lean terminology for unneeded operations. Examples in rail yards include: rework, accidents, injuries, car damage, unnecessary motion, and unnecessary information collection (Dirnberger and Barkan 2007). Most managers focus on the reduction of direct waste, but spend less effort on reducing variability. Variability, however, is a fundamental source of waste, as it necessitates buffering in the form of extra inventory, capacity, or time (Hopp and Spearman 2004). In the rail yard, sources of excessive inventory buffering include variability in: fueling requirements, the number of railcars or locomotives requiring maintenance, and the extent of the maintenance required. These buffers can come in the form of reserve supplies of diesel fuel, freight car and locomotive parts, etc. Variability in train arrivals and unexpected defects requiring maintenance result in excess capacity buffers, which may include extra yard tracks, car inspectors, or repair personnel. Finally, variability in arrival times, inspection and repair times, or labor availability may be buffered by adding “slack time” in the train schedule. All of these buffers are a result of the uncertainty inherent to the various processes within the rail yard, and they lead to unnecessary costs in the form of indirect waste.

Adapting work from Hopp and Spearman (2004), Dirnberger developed steps for implementing Lean Railroading in terminals (Dirnberger 2006). These steps included: eliminating direct waste, swapping buffers, reducing variability, and performing continuous improvement. Applying a version of Lean Railroading in their yards, CPR saw dramatic

improvements over a one-year period: average terminal dwell dropped by over 28%, average terminal capacity increased by 40%, and average train speed increased 3.6 mph (Dirnberger 2006). Several other railroads and railroad suppliers including UP, BNSF, NS, Belt Railway of Chicago, and GE Yard Solutions are now applying aspects of Lean Railroading to improve terminal performance (Dirnberger and Barkan 2007). As railroads continually seek to improve terminal performance, new methods and technologies will be integrated into the yard system to further eliminate waste and reduce variability. Improving railcar inspection and maintenance practices is one avenue for integrating lean processes with railroad terminal operations.

5.1.3 Automation and Inspection

The Toyota Production System that first popularized the concept of just-in-time (JIT) production was a predecessor to the concept of lean production (Womack et al. 1990). In addition to JIT, a major element of the Toyota Production System is automation, or “automation with a human touch” (Hopp and Spearman 2010, Ohno 1988). In the same way that lean techniques have been applied to rail terminal operations in a broader sense, the principles of automation can be applied to railcar inspection and maintenance practices to improve terminal performance. As stated above, a railroad terminal can be viewed as an industrial production system. If the product being “manufactured” is efficient, safe, and reliable transportation provided by trains, then the train inspection process can be likened to a form of quality control. In many industrial settings, quality control requires visual inspection, which can include manual inspection, automated inspection, or a hybridization of the two (Table 5.1).

Table 5.1 Comparison of Various Inspection Systems (Adapted from Hou et al. 1993)

System	Search	Decision	Remarks
Pure human inspection	H	H	Time consuming, but effective
Computer-search human decision	C	H	Efficient and effective, applicable to newer technologies
Human-computer decision-making	C	H + C	Efficient and effective, for well-established technologies
Pure automated inspection	C	C	Efficient but subject to false alarms

H = Human, C = Computer

Models of humans and machines have been used to derive hybrid automation, which typically performs better than either human or machines alone (Hou et al. 1993, Chi and Drury 2001). In general, machines are faster at performing defect detection (search) functions, while humans are better at making decisions regarding the validity and/or severity of defects (Hou et al. 1993). In some cases, machines can be useful in aiding a human in those decisions. For example, a computer-vision system could highlight a location within a digital image where a defect may be present, and the human operator would decide whether or not the highlighted section actually contains a defect. Railcar inspection systems with well-established detection mechanisms (e.g. WILDs or ABDs) could be programmed so that a computer performs the decision function when the likelihood of a defect is high (e.g. a wheel impact load of over 100,000 lbs.), but the decision is deferred to a human inspector when the defect likelihood is lower (e.g. a wheel impact under 80,000 lbs).

In other cases such as machine vision technology, the machine may not always be capable of making accurate decisions, so a computer-search human decision system would be most appropriate. For example, a machine vision system may identify a line of mud or dirt as a possible cracked center sill. The system could flag this car, highlight the location in question, and allow the car inspector to visually inspect the center sill and confirm or reject the computer's suggestion. Regardless of the system arrangement, these technologies would eliminate wasted

effort and allow car inspectors to focus their attention on the cars that are most likely to have component defects.

5.2 Methodology: Applying Lean to Railcar Inspection

Using the four step process developed by Dirnberger (2006), I applied the following Lean Railroading process to railcar inspection and maintenance practices:

1) eliminate direct waste, 2) swap buffers, 3) reduce variability, and 4) perform continuous improvement. Data from a major US Class I railroad terminal were used to assess the potential cost benefits of using ACMT in conjunction with lean techniques.

5.2.1 Eliminate Direct Waste

The main goal of any lean production system is to convert waste into value. The first step in eliminating waste is to separate the value-adding operations in the system from the non-value adding operations. Actions that create no value but are unavoidable with current technologies are considered Type I waste, whereas steps that create no value and can be immediately avoided are considered Type II waste (Womack and Jones 2003). In this case study of railcar inspection processes, I consider both Type I and Type II waste.

5.2.1.1 Type I Waste: Inherent but Unavoidable Waste

One example of Type I waste inherent to railcar inspection is the tagging of bad order cars. As discussed in Chapter 3, each time a car inspector identifies a railcar in need of major repair, a bad order card (Figure 3.6) must be completed and affixed to each side of the railcar. The tagging of bad order cards creates Type I waste because there is currently no available technology designed to automate this process, thus it must be performed manually. Data from empty coal train inspections in one major US Class I railroad terminal indicate a linear increase of approximately 9.9 minutes (0.166 hrs) in total inspection time for every additional bad order

identified by a car inspector (Figure 5.1).

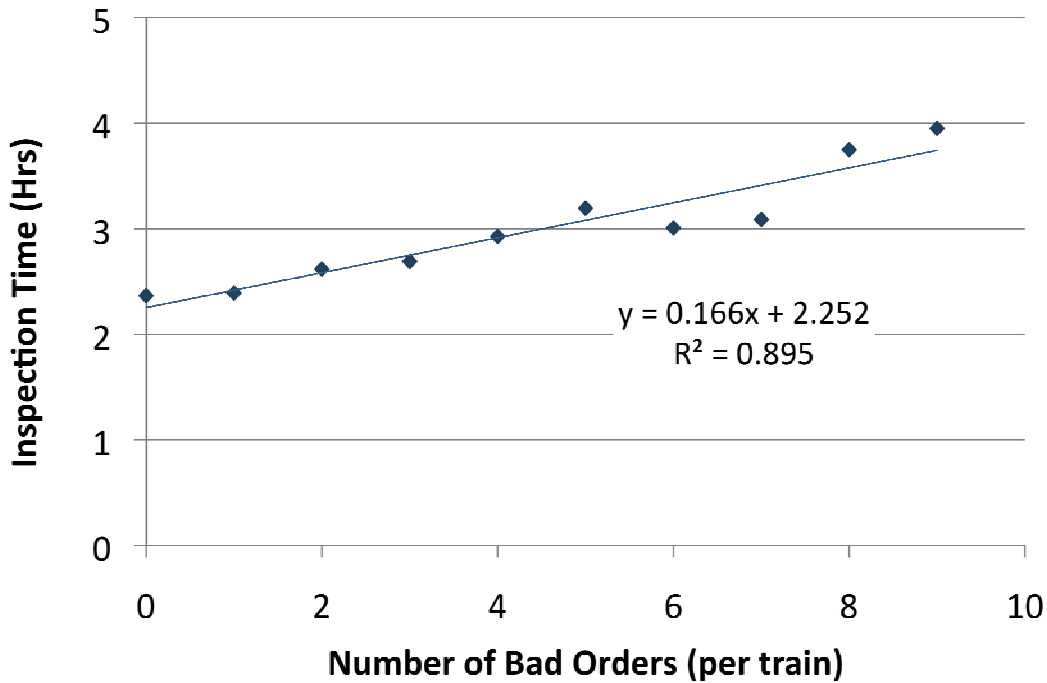

Figure 5.1 Average Coal Train Inspection Times as a Function of the Number of Bad Orders Found per Train

These data suggest that it takes car inspectors approximately 10 minutes to perform the following tasks: 1) identify an FRA-reportable defect, 2) complete required documentation on the bad order cards, and 3) attach one bad order card to each side of the defective railcar. By lean production standards, this process creates Type I waste, because it does not improve the train's condition, and if the appropriate technology and procedures were in place, the time needed for this process could be greatly reduced.

Nationwide, hundreds of thousands of freight cars are bad ordered each year. Therefore, assuming new technology could reduce the time needed to document a bad order, the railroad industry could substantially reduced Type I waste in railroad terminals. This could be accomplished by linking wayside detection systems and automatic equipment identification

(AEI) data with handheld devices in the yard, allowing car inspectors to electronically bad order cars. Innovations such as this would improve productivity through the elimination of wasted effort.

5.2.1.2 Type II Waste: Immediately Avoidable Waste

An inspection process, by definition, does not add value to the customer and therefore generates operational waste. In many industries, product inspection (i.e. quality control) is a necessary requirement due to imperfections in the manufacturing system. In the yard production system, the products (outbound trains equipped with the necessary resources to travel safely and reliably to their next destination) are made of many reusable parts (locomotives and railcars), some of which contain defects with varying levels of severity. Railcar inspection, in and of itself, does not add value to the product, but rather allows the opportunity for value to be added through car repair and more reliable, efficient train operation. After inspecting an entire train, a car inspector has not added value to that train unless he or she has made a repair or in some other way improved the condition of at least one railcar in the train. For this reason, a primary industry goal for improving railcar maintenance practices is to “turn finders into fixers” (Railway Age 2009). ACMT can be used to find defects so railroad mechanical department personnel can spend their time adding value to the product.

A specific example of Type II waste is the unnecessary redundancy that occurs when railcars are inspected too often. Under current industry practices, non-defective railcars are regularly inspected numerous times between origin and destination. In general, there is no system in place to record the results of these inspections. This process is redundant, inefficient and suboptimal in terms of achieving the actual goal of finding and repairing defects before they cause a problem. Inspectors have no way to know with any certainty if a particular component

was found to be in satisfactory condition at the previous inspection point. Consequently, they must expend time inspecting all components, regardless of their actual condition. This process is repeated over and over again with the result that some components that are quickly inspected are over-monitored. Meanwhile, components or conditions on the railcar that are difficult to assess may not be carefully or frequently observed. This result is a direct outcome of adherence to the current regulations that emphasize inspection frequency, not efficient detection and repair of defects.

Recently, there have been efforts to reduce the time car inspectors spend inspecting healthy (non-defective) railcars. In 2008 the FRA amended the regulations pertaining to freight equipment to allow trains equipped with electronically controlled pneumatic (ECP) brakes to travel up to 3,500 miles before stopping for an air-brake inspection (US DOT 2010). Through the implementation of ECP brakes, railroads can reduce Type II waste and immediately recover the labor costs associated with excessive car inspections, while at the same time achieve the associated safety benefits.

Data collected at one Class I railroad terminal indicate that manual Class IA inspections take between 80 and 140 minutes (1.33 to 2.33 hours) per train, depending on train type (Figure 5.2). Train inspection procedures on most Class I railroads use two car inspectors per train, one on each side of the train. As a result, a 140-minute coal train inspection requires 4.66 person-hours of labor. These inspection times are generally consistent with observations at other Class I railroad terminals.

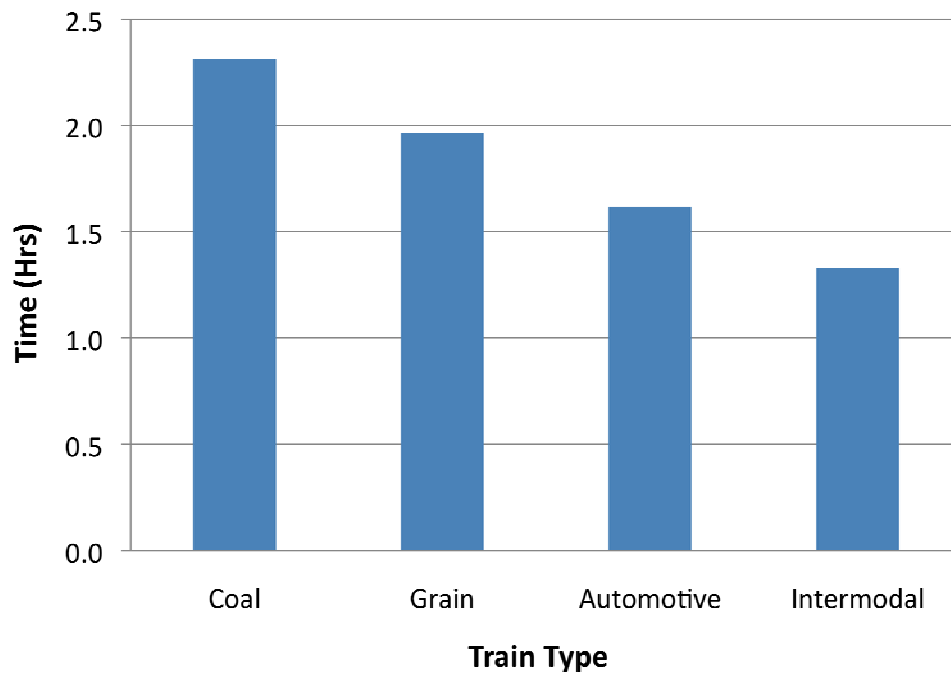

Figure 5.2 Average Train Inspection Times for Various Train Types

Differences in inspection times are likely the result of differences in train length and the priorities placed on different train types, with intermodal trains having the highest priority. Since most inspections require one car inspector to be positioned on each side of the train, this results in 2.67 to 4.67 person-hours of labor per train. Since most trains contain only a few cars with component defects, the majority of this time involves inspecting cars that have none. Therefore, by equipping trains with ECP brakes, railroads could run unit trains 3.5 times farther between inspections, resulting in the elimination of one or two Class IA inspections per long-haul train. The reduction in Type II waste alone would not be enough to justify the cost of retrofitting an entire train with ECP brakes; however, this is a major factor that should be considered when assessing the potential benefits of ECP brakes. Furthermore, as ACMT continues to develop and more systems are validated for accuracy, additional regulatory relief may be offered by the FRA.

This would allow for longer distances between Class IA inspections on routes containing a sufficient number of wayside condition monitoring sites.

5.2.2 Swap Buffers

To improve efficiency, buffers can be swapped to eliminate indirect waste. According to lean methodology, for a given set of resources, when one buffer is reduced, another buffer must be increased. A common practice of Lean Railroading is to decrease the time buffer (dwell time) by increasing either the inventory or capacity buffer (Dirnberger and Barkan 2007). One example of how buffers can be swapped as a result of ACMT is by shifting mechanical personnel from inspection tasks to repair activities. As ACMT is used to augment manual railcar inspections, less labor will be required to perform the same number of inspections. As a result, railroad managers can shift personnel from the inspection yard to the repair facility, reducing the time buffer and increasing the capacity buffer. This increase in the capacity buffer would potentially allow more cars to be repaired. In this way, waste can be eliminated and value added to the system through car repair. However, there may be factors that limit the extent to which the capacity buffer can be increased such as the size of the repair facility or the number of available repair tracks. As a result, railroads must incorporate a broad, system-wide view of all relevant processes before appropriate buffers can be determined.

5.2.3 Reduce Variability

Variability is a subtle but important source of waste. By reducing system variability, tasks can become more autonomous and buffers can be reduced. The maintenance of railcars is subject to considerable variability because bad orders of varying degrees of severity are often encountered and must be addressed. This variability can lead to waste because resources, including replacement parts and labor, are limited. For example, if there are only a few bad

orders during the course of one week, the extra unused parts remain unused and repair personnel sit idle. Conversely, if there are more bad orders than usual, there may not be enough repair personnel to perform all the work, they may run out of replacement parts, and there may not be enough capacity for the cars to be accommodated in the repair facility. Thus, variability in the car inspection process leads to variability in the car repair process, resulting in an increase in the time buffer and impeding the efficiency of the more important, value-adding activities.

When a train contains more defective railcars than normal, there is a negative impact on productivity. Data from one Class I railroad terminal indicates that repair time for wheelset replacement increases non-linearly as the number of bad orders per train increases (Figure 5.3), suggesting a loss in repair efficiency as the number of bad ordered wheelsets increases.

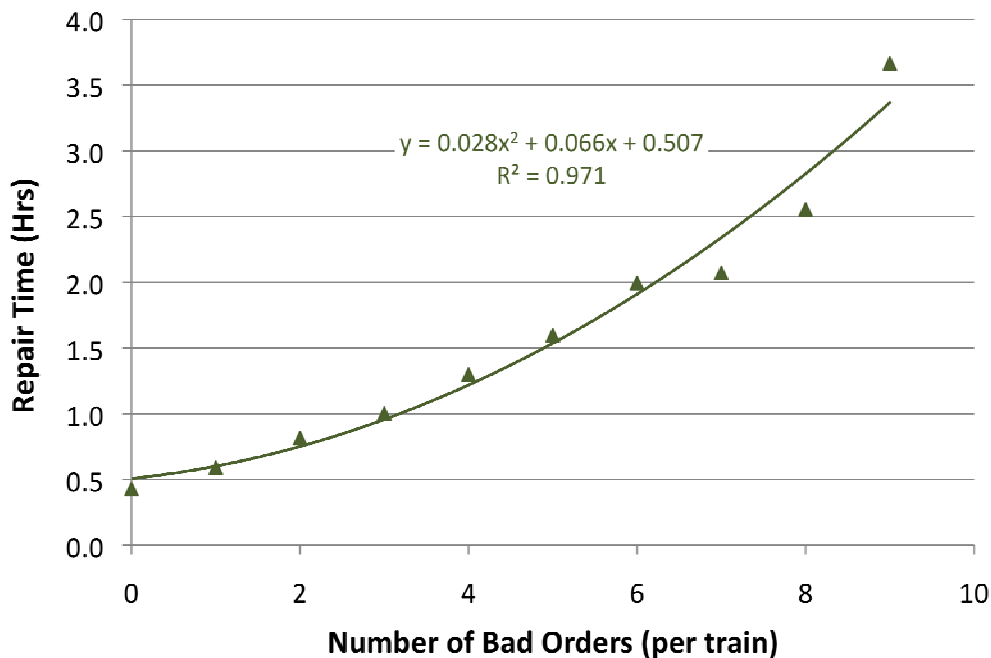

Figure 5.3 Average Wheelset Replacement Times at a Major US Class I Railroad Terminal, 2008-2009

In order to maintain a high level of efficiency, the variability in the number of required repairs should be reduced. A lean production method of reducing variability is to regulate work-

in-process (WIP) levels. WIP is the amount of unfinished product that is moving through the manufacturing system at a given time. In the context of railcar inspection, condition-based maintenance can help regulate WIP and reduce variability. Condition-based maintenance (CBM) is a form of preventive maintenance based on vehicle performance and/or parameter monitoring and involves taking corrective action prior to component failure (Lagnebäck 2007). If wayside detection thresholds are set appropriately, not only can component deterioration be detected at an early stage in order to prevent derailments, but maintenance can also be planned efficiently and WIP levels can be regulated to reduce system variability. If the condition of railcar components can be monitored in such a way that a “window-of-opportunity” is identified for all repair types, then railroad managers could potentially select an optimal workload for their repair personnel and facility. Defects that are condemnable by FRA requirements, or otherwise needing immediate attention, would have the highest priority, but less severe defects within the window-of-opportunity would not have to be repaired unless there were sufficient resources to address the specific defect. These types of “opportunistic repairs” are currently possible through the use of WILDs and ABDs, but other forms of ACMT are not yet capable of this level of CBM. As development and implementation of ACMT progresses, other methods may be used, such as Statistical Process Control (SPC), to develop optimal wayside detector thresholds to appropriately reduce car maintenance variability while ensuring that critical defects are repaired prior to failure. These methods would provide railroad managers the ability to maximize the efficiency of their workforce and reduce time and inventory buffers.

5.2.4 Continuous Improvement

As new inspection technologies are developed and implemented, the railcar maintenance process will need to be continually examined and improved. Regardless of how diligently

managers pursue the reduction of variability, it will always exist in the production system (Hopp and Spearman 2010). As a result, railroad management should take an active approach towards balancing time, inventory, and capacity buffers. As the maintenance process becomes more and more predictive, new railcar parts can be ordered as they are needed, rather than keeping large stockpiles of unused parts. As demonstrated by Toyota's JIT production methods, this approach to maintenance will reduce the inventory buffer. In addition, as railcars are maintained more efficiently, car availability and asset utilization will improve, railcar cycle times will decrease, and fewer cars will be required to provide the same level of service. This increase in the capacity buffer will result in various management options:

1) liquidate rolling stock assets and recover capital investment costs, 2) consolidate or remove storage tracks to recover capital investment and maintenance costs associated with underutilized infrastructure, or 3) absorb the additional capacity by pursuing new business. In this way, application of lean principles through the use of ACMT can have lasting and far-reaching economic benefits.

5.3 Results

5.3.1 Calculation of Current Waste Due to 1,000-Mile Unit Train Inspections

The largest portion of waste associated with the maintenance of railcars is the manual inspection of railcars without defects. As ACMT develops, wayside detection systems will provide the capability of performing comprehensive and autonomous inspection of all aspects of the railcar, leaving inspection personnel with responsibility to verify defects identified by the automated system and make necessary repairs. In this way, waste will be reduced from the time required to inspect an entire train to the time required to inspect several defective (or potentially defective) cars per train.

The greatest initial benefit, in terms of waste reduction, will be reduced labor during the inspection of unit trains. Since these trains often travel long distances, they are required to stop for FRA Class IA, 1,000-mile air brake inspections. Unless the locomotives need refueling or a new train crew, this inspection is the only reason for the intermediate stop. In addition, unit trains will be the first to benefit from ACMT that incorporates machine vision technology. The first generations of many of the computer algorithms required for these systems were developed to inspect cars that are similar in design. In my preliminary analysis, the savings for unit train inspections are calculated using data from one Class I rail terminal that inspects a large number of unit coal trains each year.

Train inspection data for this terminal is given in Table 5.2. In order to quantify the savings due to waste reduction, the annual labor cost required for a hybridized ACMT approach (see Table 5.1) is subtracted from the annual labor costs for the conventional, manual inspection.

Table 5.2 Unit Train Inspection Data for an Example Class I Railroad Terminal

	Train Type				Total
	Coal	Grain	Automotive	Intermodal	
Average Inspection Time (hrs)	2.31	1.96	1.62	1.33	2.16*
Number of Trains Inspected per year	10,600	650	770	1,320	13,340
Percent of Trains Inspected per year (%)	79	5	6	10	100

*Weighted average

5.3.2 Manual Inspection Cost

Annual labor costs for manual Class IA unit train inspections are calculated as follows:

$$C_{\text{manual}} = 2 \times T_{\text{manual}} \times N \times S \quad (1)$$

where,

C_{manual} = total annual labor cost for manual inspections, in US dollars

T_{manual} = average manual inspection time (weighted by train type), in hours

N = number of 1,000-mile inspections per year

S = average hourly compensation for car inspectors, including benefits in US dollars

The average inspection time, T_{manual} , is determined by taking a weighted average of the inspection times for each train type from Table 5.2, resulting in 2.16 hours per train. For this terminal, N is equal to 13,340 unit train inspections per year. Converting the average annual salary of a car inspector (\$81,400 including benefits) to an hourly rate, S is equal to \$39.13 per hour (AAR 2008b). This is a conservative estimate, as mechanical department manager salaries have not been included. Multiplying all of these values by two, to account for the fact that most car inspections involve two car inspectors, C_{manual} is approximately \$2,255,280 for this terminal.

5.3.3 Hybrid ACMT Inspection Cost

For this example, I assume a computer-search human decision inspection system (Table 5.1). For this hybrid system, the ACMT identifies component defects and flags potentially defective cars before a train arrives in a yard. When the train arrives, car inspectors inspect only the flagged cars and make decisions regarding whether those cars should be repaired or bad ordered or whether they are deemed satisfactory for continued operation. Annual labor costs for hybridized unit train inspections are calculated as follows:

$$C_{hybrid} = (D \times A_{automated} + F_{automated}) \times T_{hybrid} \times N \times S \quad (2)$$

where,

C_{hybrid} = total annual labor cost for hybrid inspections, in US dollars

D = average number of detectable FRA defects per train inspection

$A_{automated}$ = average correct identification percentage for automated wayside detectors

$F_{automated}$ = average false alarm rate for automated wayside detectors

T_{hybrid} = average inspection time to verify a single component defect, in hours

As discussed in Chapter 3, the average number of detectable FRA defects per train inspection, D , is difficult to assess due to the fact that manual inspection records are not kept. For purposes of illustration, D is assumed to be 5 (approximately 3 more than the average number of defects detected per train by FRA MP&E inspectors from Table 3.1), resulting in a manual inspection accuracy of approximately 60%. Uncertainty in the value of D was addressed using a sensitivity analysis.

Current wayside inspection technology is capable of maintaining accuracies ranging from 90% to 99% (Steets and Tse 1998, Morgan 2002, Morgan and Gerald 2003, Schlake et al. 2010), so an average of 95% is used for $A_{automated}$. Although false alarm rates vary widely among systems, an average of 10% was used for $F_{automated}$. For purposes of illustration, I assume that 5 out of 100 trains containing a component defect will pass the wayside detectors without being flagged (95% correct identification rate) and an additional 10 out of 100 healthy (non-defective) trains will be incorrectly flagged by the wayside detectors (10% false alarm rate). The average inspection time required for a car inspector to verify a flagged railcar, T_{hybrid} , is assumed to be 10 minutes, regardless of train type. Using data from Table 5.2, the total labor cost associated with a hybridized inspection process (C_{hybrid}) is \$422,840 per year. Subtracting this from the labor costs required for the current manual inspection process results in \$1,832,440 of annual labor cost savings for this specific terminal.

These costs are sensitive to both the number of inspections considered, N , and the overall condition of the railcar fleet, represented in this model by D . As railcar maintenance improves and becomes more preventive due to ACMT, D should decrease over time. To better understand

the expected labor costs at varying magnitudes of N and D , I conducted a sensitivity analysis (Figure 5.4).

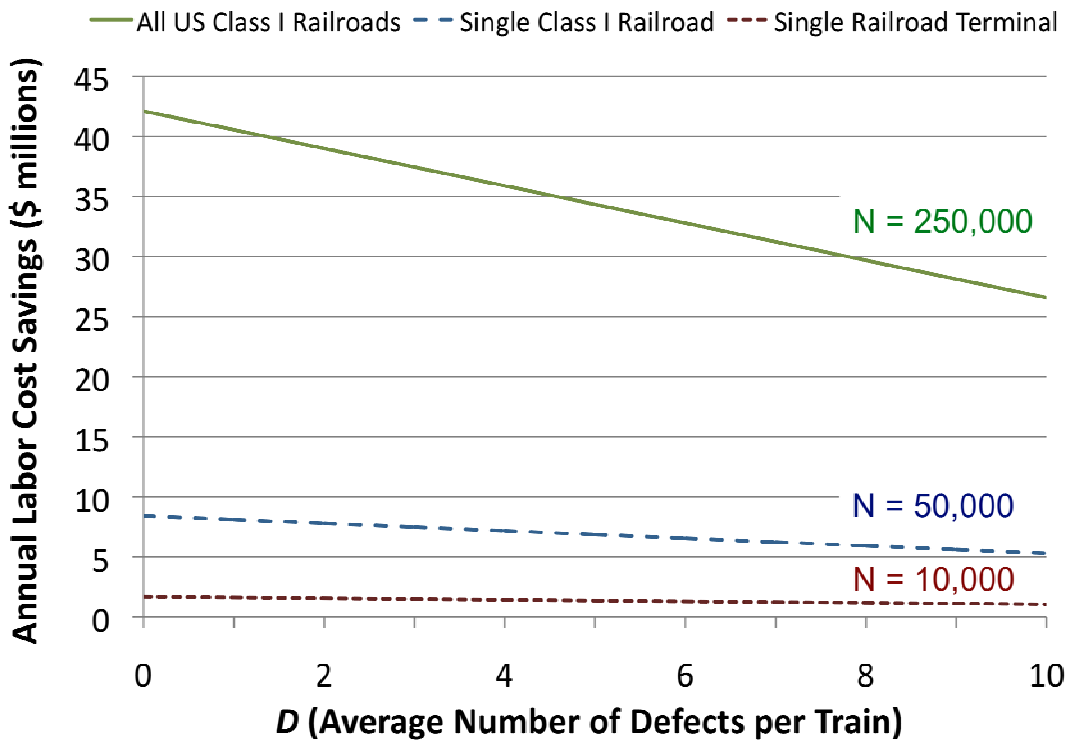

Figure 5.4 Sensitivity Analysis Showing Labor Cost Savings for Varying Levels of Railcar Fleet Size (N) and Railcar Condition (D)

In all cases, labor cost savings decrease linearly with D . Therefore, as maintenance practices improve, D will decrease and cost savings will increase. Values for N are representative of a single (major) Class I railroad terminal ($N = 10,000$), an entire Class I railroad ($N = 50,000$), and all US Class I railroads ($N = 250,000$). Although these are rough estimates, they enable comparisons among various magnitudes of N . Assuming approximately 250,000 Class IA train inspections per year and less than 5 detectable FRA defects per train inspection, the US railroad industry would save over \$35 million per year in reduced labor costs. Although not included in this analysis, ACMT can also provide additional savings as preventive maintenance strategies increase car utilization rates.

Although discussed in Section 4.3, capital and operating costs of ACMT development, installation and maintenance were not considered in the evaluation of terminal efficiency. An exhaustive study of the costs and benefits of ACMT and terminal efficiency was beyond the scope of this thesis. However, the analysis provides a basis for further, more detailed research on the benefits of applying lean methodology in conjunction with ACMT to improve terminal efficiency.

5.3.4 *Summary of Results*

This economic analysis indicates that the use of a hybridized machine-search human decision inspection process is over five times more efficient, in terms of labor costs, than pure manual inspection (i.e. $C_{manual} / C_{hybrid} = 5.3$). These results, although limited to a single Class I railroad terminal, demonstrate the potential for significant reduction in operational waste. Although wayside detection technology is not yet implemented to the level where every railroad terminal could benefit from the hybrid process, the efficiency of a large portion of these inspections could be improved by eliminating manual inspection of healthy cars. In addition to these savings, other costs can be reduced through the elimination of other forms of waste, the appropriate allocation of buffers, and the reduction of variability.

5.4 **Conclusions and Discussion**

Railroad yards, like other manufacturing systems, can substantially benefit from the application of lean production methods. A methodology has been presented for the application of Lean Railroading to railcar inspection and maintenance practices using the four-step approach of: 1) eliminating direct waste, 2) swapping buffers, 3) reducing variability, and 4) performing continuous improvement. An example Class I railroad terminal was used to calculate the potential reduction in direct waste, and a savings of approximately \$1.8 million was estimated

for a single terminal. If these results are extended to the Class I railroad industry, implementation of the first step of Lean Railroading could save them over \$35 million per year. Through the implementation of steps 2 through 4, additional operational cost savings could be realized.

In order to eliminate the operational waste associated with railcar inspection practices, two industry milestones must be reached. First, automated wayside detection systems capable of monitoring all safety-critical railcar components must be fully developed and integrated. This will require the development of reliable and robust condition monitoring systems capable of addressing every aspect of the FRA Class IA 1,000-mile air-brake inspection. When this is achieved, new regulations may then be adopted to allow automated technology to augment manual inspection, resulting in a more effective and efficient hybrid system. The industry has already begun to move in this direction, as regulations have been introduced to allow extended-haul trains to travel up to 1,500 miles before stopping for a required inspection (US DOT 2010). In addition, trains equipped with electronically controlled pneumatic (ECP) brakes are permitted to travel up to 3,500 miles before a required air brake inspection (US DOT 2010). As wayside detection systems are further incorporated into railroad mechanical practices, the distance between inspections may be increased and/or the labor requirements for individual inspections reduced.

CHAPTER 6: MAINLINE EFFICIENCY

6.1 Lean Approach to Evaluate Mainline Efficiency

In Chapter 5, the concept of Lean Railroading was introduced and applied to yards and terminals to determine the potential impact of improved inspection and maintenance practices on terminal performance. To understand the broader impact of ACMT on network efficiency, mainlines operations must also be considered. In this chapter, the lean principles of waste elimination and variability reduction are used to understand potential gains in mainline efficiency. First, simulation data and a linear train delay cost calculator (TDCC) were used to quantify the direct waste associated with equipment-caused in-service failures (ISFs) for a single-track route. Next, a similar analysis was conducted using both single and double-track routes to assess changes in variability as a function of both traffic density and length of ISF.

6.2 Analysis of Train Delay

As US freight traffic volumes have risen in recent years, research has been undertaken to better understand train delay and the impact of delay on network capacity and reliability. Schafer (2006) developed a train delay cost calculator (TDCC) to estimate the amount of train delay and the corresponding costs of broken rail derailments and service failures. In 2009, a study was conducted to understand the impact of higher train speed on freight railroad mainline capacity (Harrod 2009). More recent research has used Rail Traffic Controller (RTC) from Berkeley Simulation Software to analyze the impact of train type heterogeneity on railway capacity (Dingler et al. 2009). RTC is a dispatch simulation software package used by the North American railroad industry to simulate both freight and passenger train operations (PBQ&D 2002, WGI 2007). Dingler (2010) provides an in-depth study of the use of RTC to investigate train delay and its relationship to capacity (Dingler 2010). In the current study, I conducted RTC

simulations on both single and double-track routes. I used results from these simulations to assess the potential economic impact of reducing equipment-related ISFs through the use of ACMT.

ISFs result in both primary and secondary delays. Primary, or exogenous delay is direct delay due to an external event affecting only the train experiencing a mechanical defect (Mattsson 2007). This includes either the time needed to repair a broken or defective railcar while on the mainline, or the time required to set out a car on a passing siding for future repair. Secondary delay, also called reactionary delay (Gibson et al. 2002), is the delay to all other trains in the network that are affected in some manner by the service outage. According to lean principles, both primary and secondary train delay due to equipment-caused ISFs represent direct waste in the railroad network. Through improved CBM afforded by ACMT, the frequency of ISFs, and the resulting operational waste, could be greatly reduced.

In this study, I analyzed the effect of train delay on unit coal train traffic. In 2008, coal traffic comprised the greatest portion of tonnage and carloads originated (45 and 26 percent, respectively) and the most gross revenue (24 percent) among all commodities transported by the US Class I railroads (AAR 2009b). Additionally, unit coal trains operate on some of the highest density rail corridors in North America, where delays due to ISFs have the greatest impact. Another reason for analyzing unit coal train traffic is the small variation in the design of railcars used to transport coal. This uniformity is advantageous for the design and implementation of machine vision and certain other condition monitoring systems. For both of these reasons, the first applications for many ACMT systems will be unit train inspection on high-density coal routes.

6.3 Train Delay Cost Calculator (TDCC)

The total cost due to train delay from a service interruption can be estimated using the following formula modified from Schafer (2006):

$$C = Tx + \sum_{n=1}^m (T - nt)x \quad (3)$$

where,

C = total train delay cost for multiple trains

T = total delay time for service interruption

x = cost of delay per train-hour

m = number of following trains delayed = T/t (rounded to the nearest integer)

t = hours per train arrival (24 hours / number trains per day)

The TDCC represented by Equation 3 provides a cost estimate based on traffic volume (in trains per day) for a single-track route segment and assumes that trains arrive at constant time intervals from both directions. At least one US class I railroad estimates major derailments using a linear approximation, similar to the TDCC. Using this equation, total train delay (i.e. C/x) was determined for 1, 3, and 5-hour ISFs on a single-track mainline route (Figure 6.1).

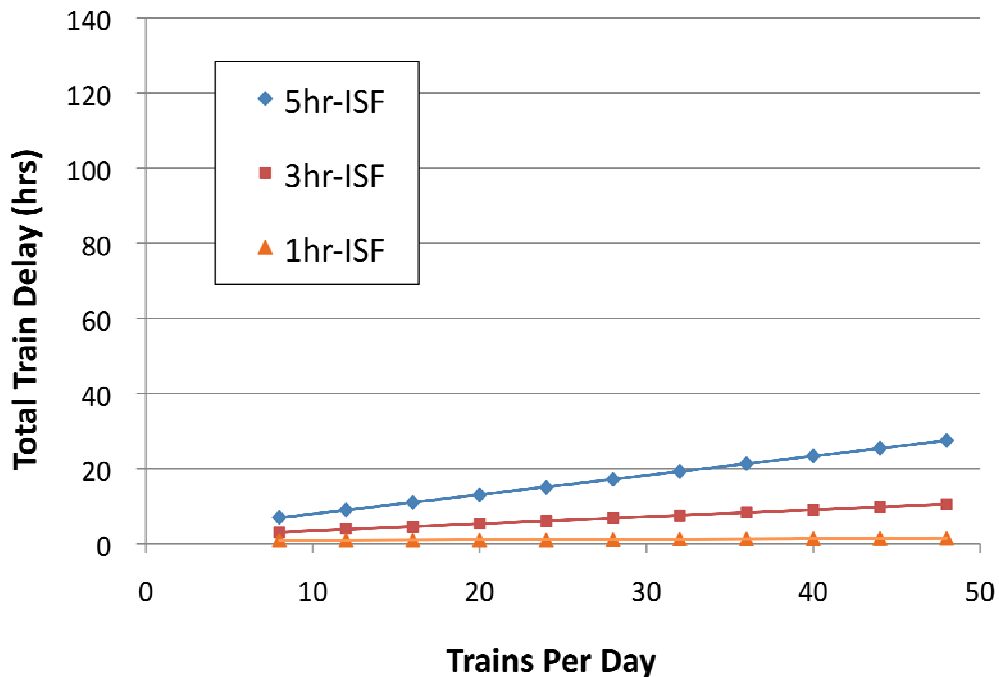

Figure 6.1 Total Delay Times for Various Durations of ISF Calculated Using the TDCC (Equation 3)

Using the TDCC, total train delay increases linearly with traffic volume. In addition, total train delay also increases with the length of ISF. The linear increase in delay with traffic volume is due to an increase in secondary delay. At low traffic volumes, the other trains on the route are unaffected because the average headway (i.e. the spacing between trains) is longer than the ISF. Therefore, for all traffic volumes less than 24 trains per day (one per hour), a one-hour ISF results in only the one hour of primary delay. However, at the other extreme, a 5-hour ISF on a track segment with 40 trains per day would cause over 23 hours of total train delay. In this case, the total secondary delay is approximately 18 hours.

6.4 Dispatch Simulation Analysis – Single-Track Route

A common method of calculating train delay is through the use of dispatch simulation software, such as RTC. Previous rail capacity research using RTC provides a substantial

background for the application of this software (Dingler 2010). A similar methodology was used in the current study, including the development of a representative North American single-track mainline subdivision and corresponding train schedule (Table 6.1).

Table 6.1 Parameters used for Single-Track RTC Simulations

Route Characteristics	Train Characteristics
260 miles long	Unit coal trains
10 miles between control points	115 cars, 6,325 ft. long
8,000 ft. signaled sidings	16,445 tons per train (loaded)
2.5-mile signal spacing	3,795 tons per train (empty)
3-block, 4-aspect signaling	0.78 HP / trailing ton
0% grade and curvature	3 SD70 4,300 HP locomotives
	Maximum speed: 50 mph

The attributes used for this simulation are idealized for simplicity, as the purpose of this study is to determine the relative impacts of ISF length and traffic volume on mainline train delay. This analysis provides a baseline cost estimate for a typical rail route; however, estimation of costs for a particular route would require the actual characteristics specific to that route. The analysis presented here is intended as a guide to the methodology and to provide insights regarding the relative magnitude of the effects that might be expected in a route-specific analysis.

Traffic consisted of 115-car unit coal trains on a 260-mile, single-track route. In order to replicate typical coal route operations, loaded trains were run in one direction along the route, while empty trains were run in the opposite direction. During the simulation, a train was stopped at random times on the mainline in order to replicate 1, 3, and 5-hour ISFs. Twenty-four simulations were performed using a random variation of train starts, with each train departing within a range of 30-minutes. In other words, each train departure could vary by plus or minus 15 minutes from its scheduled departure time. The total delay time was determined by

subtracting the inherent delay for the base case (i.e. simulations without a service failure) from the delay for the simulations where an ISF was initiated (Figure 6.2).

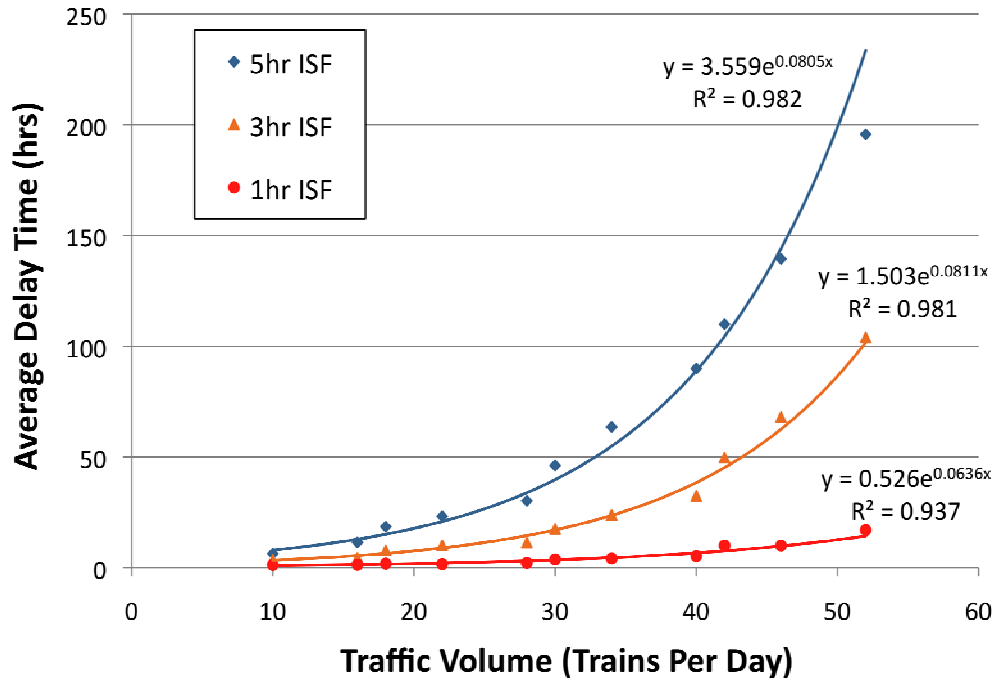

Figure 6.2 Average Train Delay Data Generated from RTC Dispatch Simulation Software for Varying ISF Durations

Similar to data from the TDCC (Figure 6.1), delay times increase with traffic volume, however the RTC delay data display a different trend. At low traffic volumes, up to approximately 20 trains per day (T/D), the increase in average delay times is close to linear. A traffic volume of 20 T/D corresponds to approximately 74 annual million gross tons (ANMGT), assuming an equal amount of loaded and empty trains. However, at higher volumes (i.e. above 20 T/D), the data indicate an exponential relationship. This exponential relationship is consistent with findings from other railway capacity research (Gibson et al. 2002, Mattsson 2007). In addition, train delay curves increase more sharply for ISFs of greater duration, indicating that mainline capacity on this route is also sensitive to the length of ISF.

The increases in train delay are mainly due to an increase in secondary delay. The

primary advantage of using RTC as compared to the TDCC is the ability to more accurately predict the secondary delay caused by an ISF. For example, RTC simulations capture the “shockwave” effect created by an ISF, akin to those observed in highway traffic streams (Garber 2009). Thus, a primary advantage of using RTC as compared to a linear train delay cost calculator is the ability to more accurately predict delays to following trains that are far away from the location of the ISF. In addition, RTC incorporates the time needed for braking and acceleration, thus providing more realistic train delay estimates.

6.4.1 Delay Cost Estimation for In-Service Failures

To determine the delay cost incurred by a railroad due to an ISF, delay time is multiplied by a constant delay cost figure that includes four components: car cost, locomotive cost, fuel cost, and crew labor cost. The delay cost incorporates both the actual consumption of railroad company resources as well as the opportunity cost (in the case of cars and locomotives) of resources that are underutilized. A recent estimation of average total train delay cost was approximately \$213 per train-hour for US Class I railroads (Schafer 2006, Schafer and Barkan 2008). This figure assumed an average of 69.2 cars per train and 2.7 locomotives per train, and did not incorporate the lost revenue, or opportunity cost, due to lading delay. Dinger (2010) recently approximated lading delay for a 99-car bulk commodity unit train to be approximately \$410 per train-hour.

For the current study on coal trains, I assumed 115 cars and 3 locomotives per train. Accounting for these changes, the train delay cost (excluding lading delay) increased to \$232 per train-hour. Additionally, increasing the train length from 99 cars to 115 cars resulted in an increase in the lading delay cost, resulting in a cost of \$430 per train-hour. This results in a total train delay cost of \$662 per train-hour. Using this value, cost curves were determined at various

traffic volumes for both the TDCC estimates and RTC simulation data (Figure 6.3).

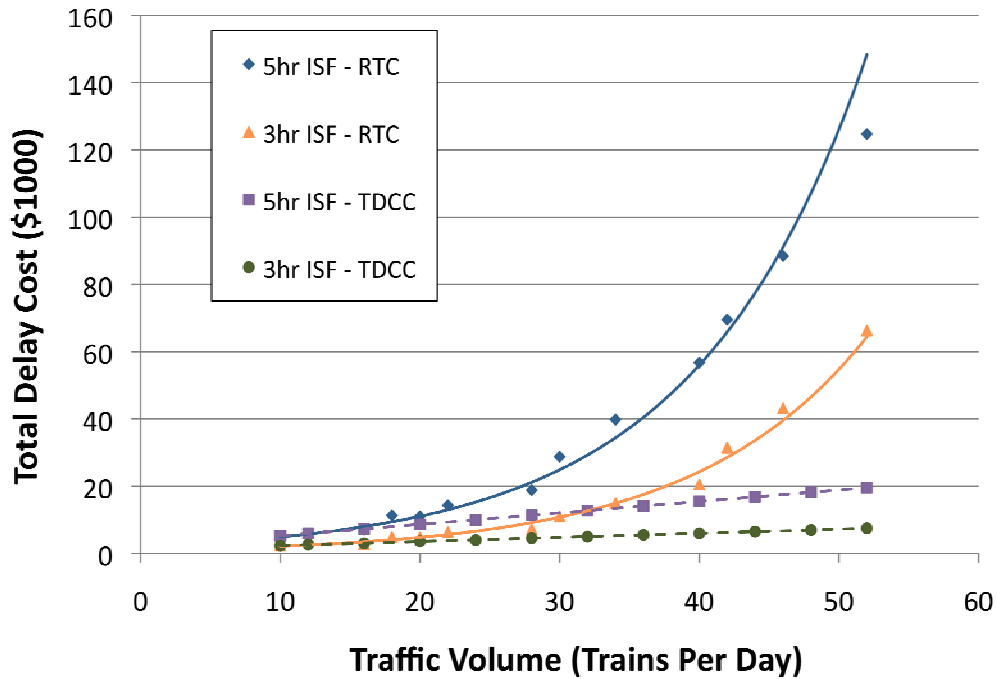

Figure 6.3 Comparison of RTC and TDCC Estimates of Total Delay Costs Due to 3 and 5-Hour ISFs at Varying Traffic Volumes

For traffic volumes up to approximately 20 T/D, total delay cost estimates using the TDCC are close to the RTC simulation estimates. At this volume, both estimation methods predict delay costs of about \$10,000 and \$4,000 for 5-hour and 3-hour ISFs respectively. Thus the TDCC can be an effective tool for estimating train delay for low and medium traffic volumes. However, at higher volumes, RTC simulation data closely follow an exponential relationship, suggesting longer total delays than predicted using the simple linear model.

RTC simulation data suggest that for traffic volumes above 40 T/D (approximately 148 ANMGT), delay costs for a 5-hour ISF would be approximately \$60,000. In most cases, however, ISFs will result in delays shorter than five hours. In general, less severe ISFs result in one of two scenarios: 1) the train will be inspected and repaired along the line-of-road and then continue service after repairs have been made, or 2) the defective railcar(s) is removed from the

train and set out at a storage track, passing siding, or yard. For either case, industry surveys estimate that the train will typically be delayed between 1 and 2 hours. Using an approximation of 1.5 hours, I estimated the potential costs of different types of ISFs at various traffic levels: low (10 T/D, or 37 ANMGT), medium (20 T/D, or 74 ANMGT), and high (40 T/D, 148 ANMGT) (Table 6.2). Given an example single-track route with a medium traffic volume and 1,000 ISFs per year, train delays would cost over \$2.1 million using the RTC cost estimate.

**Table 6.2 Delay Cost for an Example 1.5-Hour ISF;
Comparison of TDCC and RTC Estimates at Various Traffic Volumes**

Traffic Volume (Trains per Day: ANMGT)	Train Delay Cost Calculator (TDCC)	Rail Traffic Controller (RTC)
Low (10:37)	\$1,071	\$1,254
Medium (20:74)	\$1,390	\$2,126
High (40:148)	\$2,184	\$7,728

For longer mainline service outages (e.g. 24 to 48 hour ISFs caused by major derailments), it was not practical to perform RTC simulations due to the amount of time and computer memory that would be required. Therefore, the TDCC was the best option for estimating train delay costs for major derailments. Using the TDCC for a medium traffic volume of 20 T/D, a 24-hour derailment would result in approximately \$170,000 of train delay costs while a 48-hour derailment would cost approximately \$650,000. Due to the rerouting that occurs and the additional complexities that accompany derailments, actual train delay costs may be much higher. In addition, for higher traffic volumes, the delay costs would most likely increase nonlinearly, resulting in much higher values.

6.5 Dispatch Simulation Analysis – Double-Track Route

Since many of the primary corridors used to transport coal traffic experience large volumes and require a high level of maintenance, these routes are often built with multiple mainline tracks. As a result, RTC simulations were conducted using an example double-track

route. As before, 1, 3, and 5-hour ISFs were randomly initiated in order to quantify total train delay at various traffic volumes (Figure 6.4). In this case, twenty-two random simulations were conducted on the new route using the same train and route characteristics as before (Table 6.1), except that the entire route contained two mainline tracks instead of a single-track with sidings. The simulations implemented directional running (i.e. empty and loaded coal trains travelled in opposite directions, with each train type primarily using only one specified track). When necessary, trains were able to cross over to the other mainline track to run around a stopped train, following standard train dispatching rules.

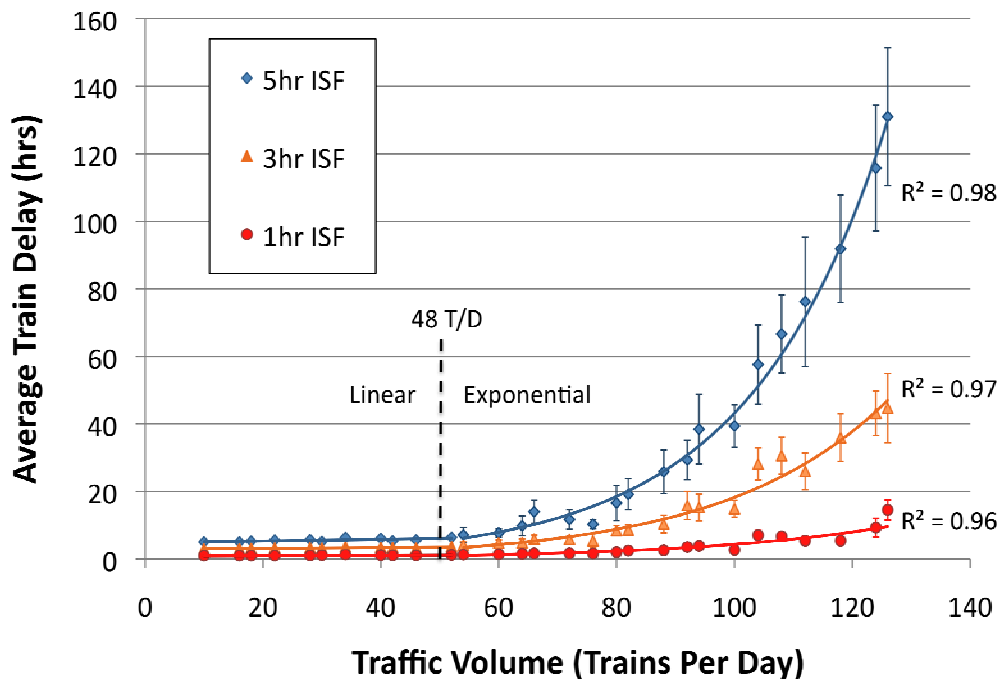

Figure 6.4 Total Train Delay as a Function of Traffic Volume with 95 Percent Confidence Intervals for 1, 3, and 5-hour ISFs on a Double-Track Route

Similar to the single-track simulations (Figure 6.2), train delay increases with an increase in either traffic volume or the length of ISF. As before, the increase is due to increased secondary delay. For traffic volumes less than approximately 48 T/D (i.e. one train on each

mainline track per hour) average train delay increases linearly with traffic volume. However, above 48 T/D, train delay increases exponentially.

In addition, variation in average delay times increases both at higher traffic volumes and for longer ISFs. A 95 percent confidence interval was used to determine the upper and lower bounds (denoted by the bars above and below each data point for average train delay) (Figure 6.4). As traffic volume increases, the confidence intervals become larger, indicating that variability is increasing. This variability in the system generates indirect waste that should be accounted for in addition to the direct waste created by train delay. An analysis of train delay variability is provided in section 6.7.

6.6 Cost Estimation Using Both Single and Double-Track Routes

Mainline capacity is directly related to the physical infrastructure along a fixed route length. Increasing the number of tracks on a line (e.g. upgrading from single-track to double-track) results in a disproportionately greater increase in network capacity (Mattsson 2007). As a result, for traffic volumes under 48 T/D (approximately 177 ANMGT) the delay costs due to ISFs on a double-track route are almost negligible in comparison to those on a single-track route. Consequently, these values are not shown in Figure 6.5. The delay costs at these low volumes are all less than \$4,500, regardless of the length of ISF and they display a linear trend as seen with the average train delay data (Figure 6.4).

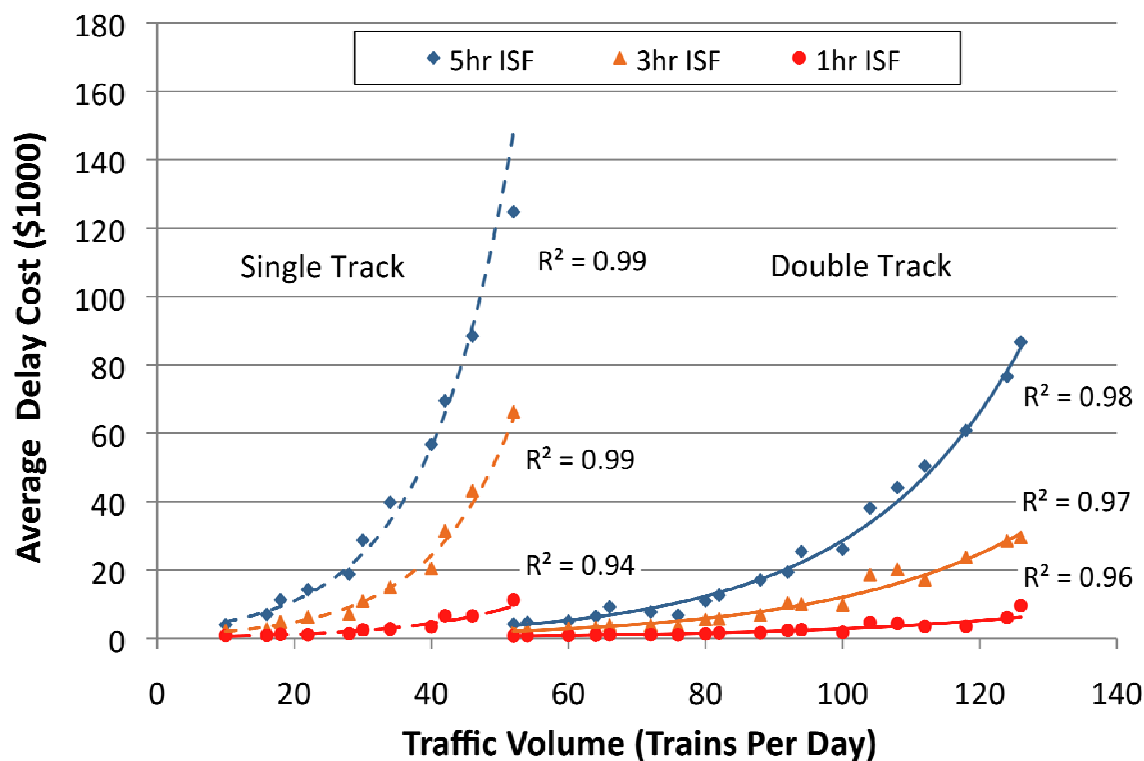

Figure 6.5 Total Train Delay as a Function of Traffic Volume for 1, 3, and 5-hour ISFs on Single and Double-Track Routes

In order to estimate the number of equipment-caused ISFs per year, I conducted a survey of three US Class I railroads. Based on data from these railroads, I estimated that there were approximately 11,500 mainline ISFs that could potentially have been detected by ACMTs (e.g. HBD stops, burnt off journals, broken axles, knuckle failures, load shifts, wheel defects, WILD stops, sticking brakes, hot wheel etc.) I did not include DED stops or ISFs related to defective air hoses because these defects are addressed by reactive technologies rather than ACMT. Since the total freight car miles traveled on the three surveyed railroads in 2008 comprised approximately 50% of all freight car miles traveled on US Class I railroads that year, I estimate a rate of approximately 670 ACMT-detectable defects per BFCM, and by extrapolation estimate that there were approximately 23,000 detectable equipment-caused ISFs in 2008. This is a

conservative estimate due to difficulties in determining the exact causes for some ISFs and exactly which defects could be detected by ACMT.

Based on these numbers, total delay costs were calculated using delay cost estimates for a 1.5-hour ISF (using RTC data and a value of \$662 per train hour) and average traffic volumes for different track types on the US railroad network (Table 6.3).

Table 6.3 Train Delay Cost and Percentage of Ton-Miles by Traffic Type Based on RTC Simulation Data for a 1.5-Hour ISF with Various Traffic Volumes (BTS 2006)

Average ANMGT	Single-Track		Double-Track	
	Delay Cost (\$)	Ton-Miles (%)	Delay Cost (\$)	Ton-Miles (%)
<40 (~37)	1,250	31.3	990	0.9
40-60	1,600	17.9	1,000	2.3
60-100	2,190	18.7	1,040	6.2
>100 (~110)	4,640	5.5	1,160	16.3
Total	--	73.5	--	25.6

Averages for the percentage of ton-miles on various single and double-track routes were determined using data from the Bureau of Transportation Statistics (BTS), National Transportation Atlas (BTS 2006). Although these ton-mile percentages include other types of traffic besides unit coal trains, final cost estimates should still be conservative because lading delay costs for other commodities will generally be higher. These data indicate that only one percent of US ton-miles are transported on routes with more than two mainline tracks, and since delay costs would be minimal, these routes were not included.

Multiplying delay costs by ton-mile percentages at each level of traffic and the total number of ISFs per year (approximately 23,000), the annual delay costs due to ISFs is approximately \$37.4 million per year for US class I railroads. For comparison, the average annual cost of track and equipment damages due to mainline derailments (from Chapter 2) was approximately \$38 million for the four largest US Class I railroads from 1999 to 2008 (US DOT

2009, Schlake et al. 2010). Thus, delay costs due to mainline delay from ISFs are comparable to costs associated with derailments.

6.7 Variability in Train Delay

Because variability results in buffering (e.g. added slack time in train schedules), it is a fundamental source of waste (Hopp and Spearman 2004). Based on RTC simulations, the variability associated with equipment-related mainline train delay increases with both traffic volume and length of ISF. Both factors were analyzed separately using frequency diagrams depicting the number of trains delayed, versus the length of individual train delay (in minutes) per 100 train miles. The lengths of individual train delays were divided into 10 frequency bins (Figure 6.6).

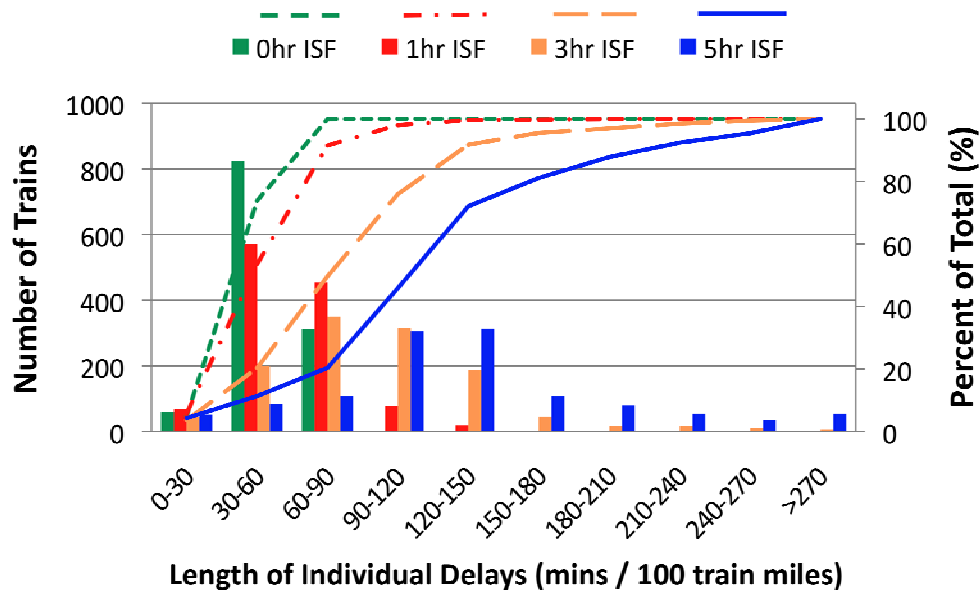

Figure 6.6 Frequency Diagram Showing the Amount of Delay For Each Train Due to Various ISFs on a Single-Track Route with 52 T/D

The frequency bins ranged from 0 to over 270 minutes for the single-track route and from 0 to 90 minutes for the double-track route. Trains in the first bin are those that experienced little or no delay, while the trains in the last bin experienced the greatest delay. Curves showing the

cumulative percentage of total trains as a function of delay length are also provided to illustrate the increase in variability.

6.7.1 Length of In-Service Failure and Variability

The first factor I analyzed was the length of ISF. To evaluate the effect of this factor, I chose simulations using the single-track route at the highest simulated traffic volume (52 T/D, or 192 ANMGT). Although this traffic volume is higher than most single-track operations, use of exaggerated conditions in the simulations enabled better understanding of the relative impacts of ISF length on mainline capacity. In the previous sections, total delay was calculated by subtracting the delay for 1, 3, and 5-hour ISFs from the base case. In this analysis, I compared the frequency of delay for ISFs with that of the base case (0hr ISF) to show changes in train delay variability. Thus, train delay for this analysis is defined as the difference between the minimum, or unopposed, run time and the actual time it takes a train to traverse the route (Dingler et al. 2009). Given this definition, over 60 percent of the trains in the base case experience between 30 and 60 minutes of delay (Figure 6.6).

As the length of ISF increases from 0 to 5 hours, both average train delay and the variability in delay increase. For the various lengths of ISF, the distribution shifts from a skewed distribution to more symmetrical, with the modal value increasing (i.e. shifting to the right) as the length of delay increases. For the base case, most trains experience 30-60 minutes of delay (per 100 train miles), while for a 5-hour ISF, the modal value increases to 120-150 minutes. In addition, the distribution curves become wider and shorter for longer ISFs, indicating an increase in variance. This increase in variance affects a railroad's level of service because when a higher percentage of trains are delayed, more customers are affected, resulting in greater potential costs to the railroad.

For double-track routes, the increases in average delay and variability are not as evident. I analyzed the same double-track route described previously, again using the highest simulated traffic volume (126 T/D, 465 ANMGT). Since there is less total delay on the double-track route, I used 10-minute frequency bins instead of the 30-minute bins used in Figure 6.6. The data show that for a 1-hour ISF, 90 percent of the trains experience little or no effect (i.e. 0 to 10 minutes of delay) and less than 1 percent of the trains are delayed for more than 40 minutes (Figure 6.7a). However, for a 5-hour ISF, only 46 percent of the trains experience little to no effect, and over 20 percent of the trains experience a delay greater than 40 minutes. Thus, the longer the ISF, the greater the number of trains affected.

In order to see the distributions of train delay more clearly, I replotted the data without the 0 to 10 minutes bin and adjusted the scale of the vertical axis (Figure 6.7b). For 1 and 3-hour ISFs, the frequency of delays decreases as the length of delay increases. However, the 5-hour ISF case had a different distribution in which the number of trains experiencing longer delays increased. These data suggest that when a service outage exceeds a certain threshold, the shockwave affecting the network becomes larger and more unpredictable. Thus, although the effects are not as pronounced as in the single-track route, the length of service outage does affect the amount of operational waste generated on the double-track route.

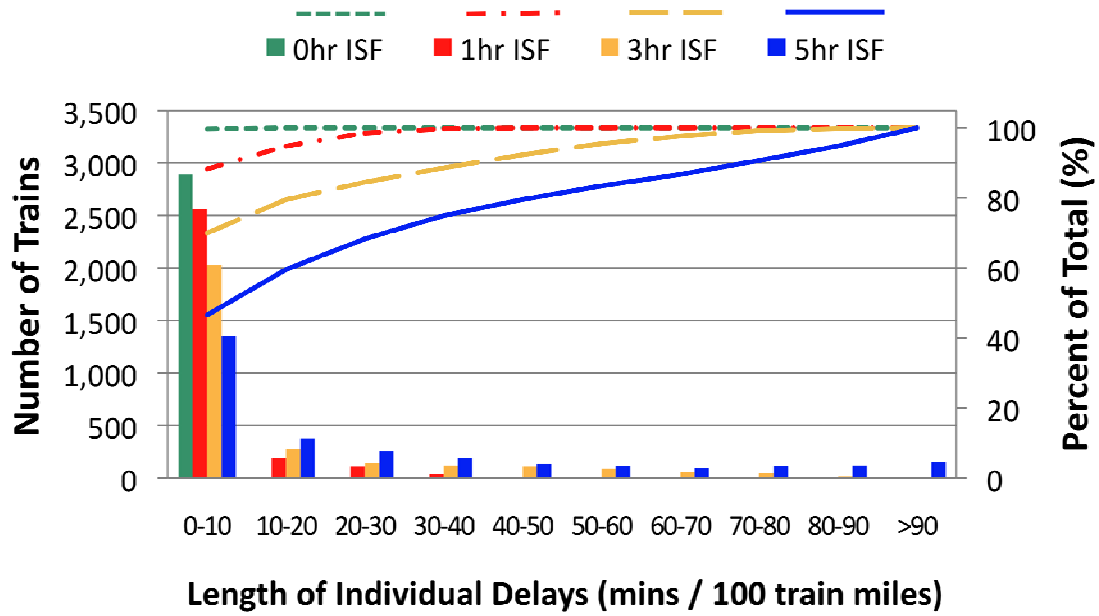

(a)

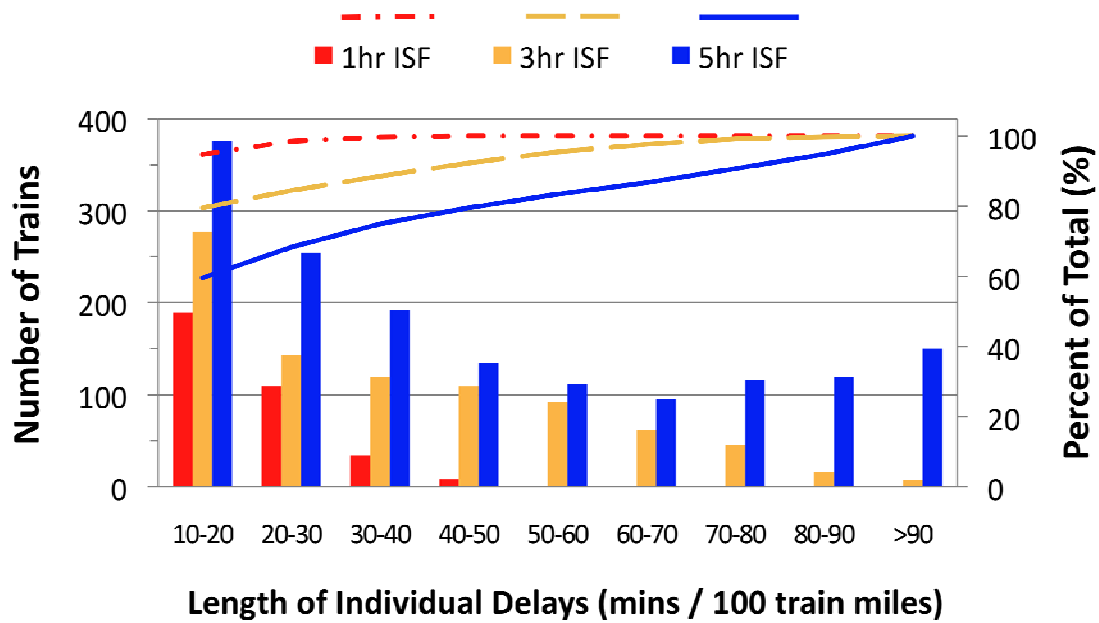

(b)

Figure 6.7 Frequency Diagrams Showing the Amount of Delay For Each Train (a) and For Trains Experiencing Delays Greater Than 10 minutes (b) Due to Various ISFs on a Double-Track Route With 126 T/D

6.7.2 Traffic Volume and Variability

The second factor I considered was traffic volume. I analyzed RTC data for a 5-hour ISF on both the single and double-track routes, with traffic volumes ranging from 16 to 52 T/D and 64 to 126 T/D, respectively (Figures 6.8 and 6.9). Similar to the impact of ISF length, increased traffic volume also results in increased variability in train delay. As before, the distribution curves for the single-track data shift to the right and become wider and shorter as traffic volume increases (Figure 6.8).

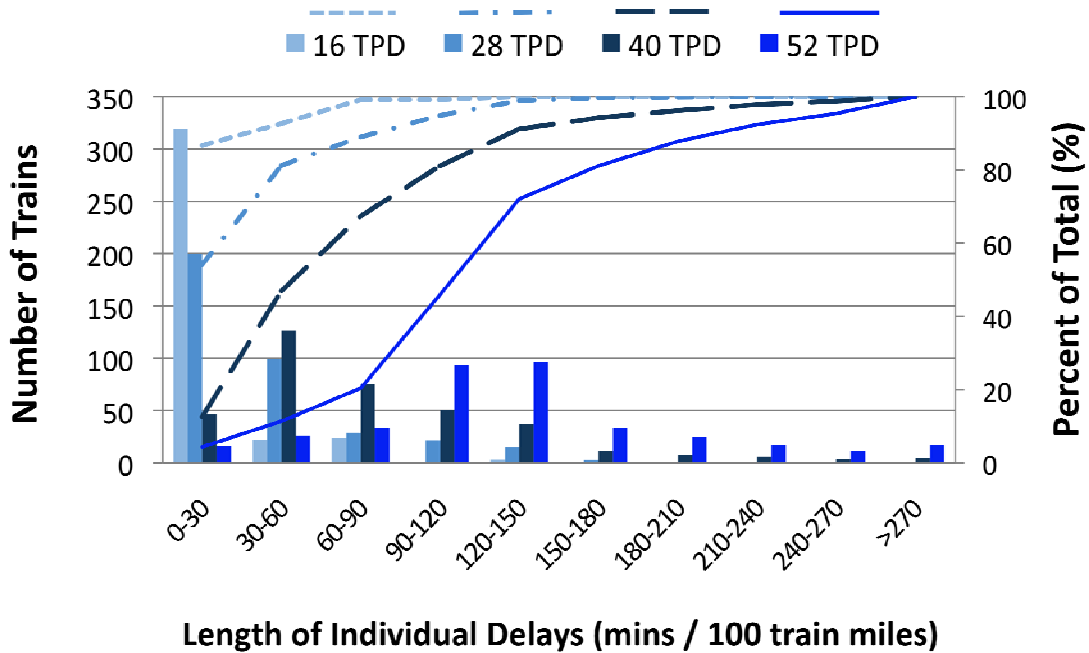
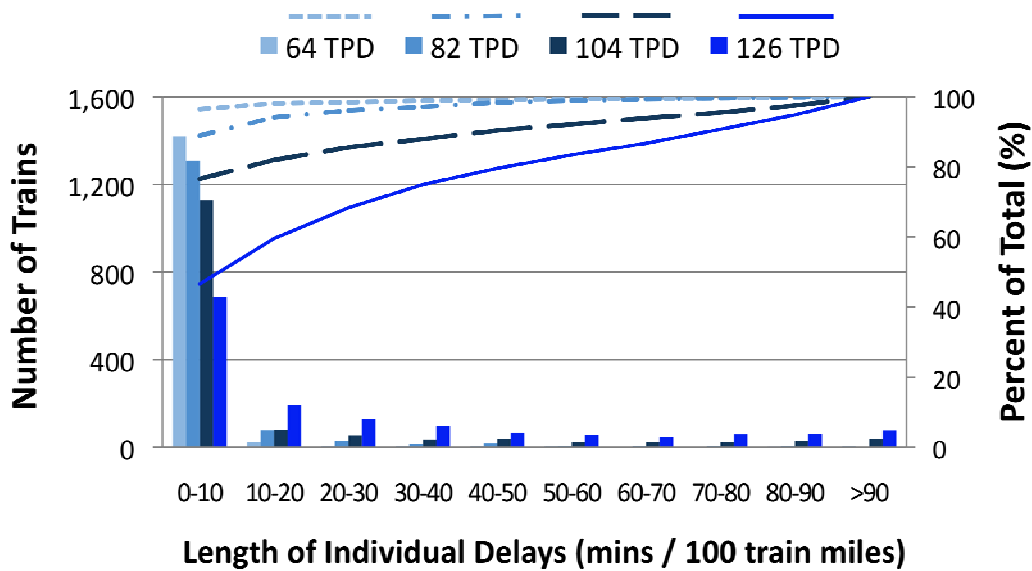
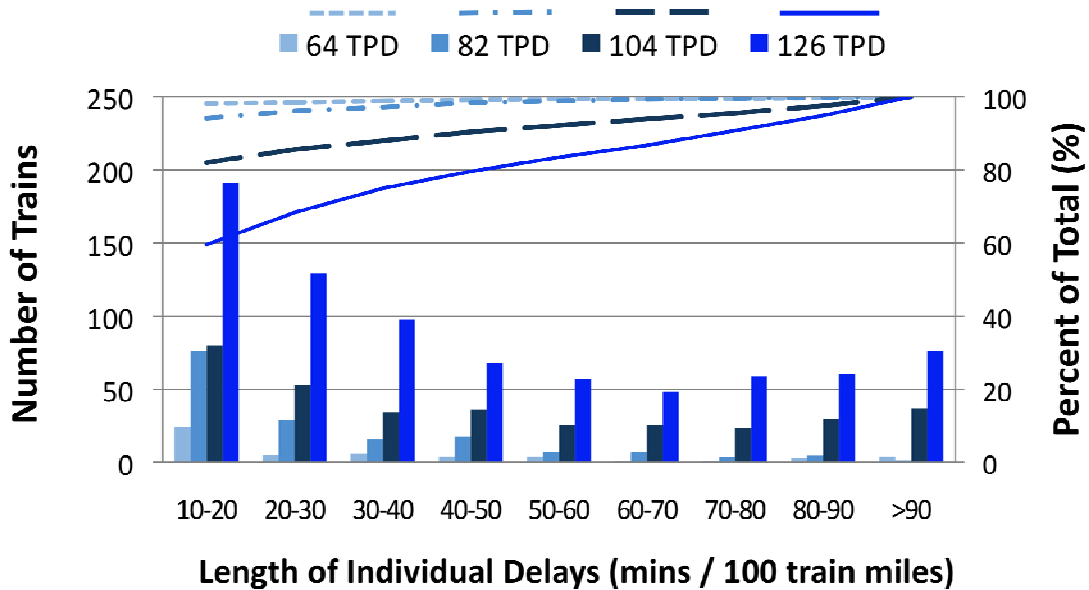

Figure 6.8 Frequency Diagram Showing the Amount of Train Delay for Each Train Due to a 5-Hour ISF on a Single-Track Route With Varying Traffic Volumes

Data for the double-track route are presented in Figure 6.9. The impact of traffic volume on train delay is less apparent on the double-track route, due to its higher line capacity. However, it is clear that average train delay and train delay variability do increase at higher traffic volumes.



(a)



(b)

Figure 6.9 Frequency Diagrams Showing Amount of Train Delay For Each Train (a) and For Trains Experiencing a Delay Greater Than 10 Minutes (b) Due to a 5-Hour ISF on a Double-Track Route With Varying Traffic Volumes

For very high traffic volumes (i.e. above 82 T/D, or 302 ANMGT), the train frequency distributions (Figure 6.9b) follow the same trend as in Figure 6.7b. The number of trains delayed

decreases until the length of individual train delay reaches approximately 70 minutes, and then begins to increase. As before, when traffic volumes exceed a certain threshold, the shockwave affecting the network becomes larger and more unpredictable. Therefore, the mechanical reliability of freight cars becomes more important at higher traffic levels. Although this is true for double-track, its impact is much greater on single-track routes.

6.8 Conclusions

The effectiveness of railcar condition monitoring has a large impact on rail transportation efficiency. I used dispatch simulation software to analyze the effect of ISF duration and traffic volume on single and double-track versions of a hypothetical route to estimate delay. The simulations indicated that both traffic volume and length of ISF had a nonlinear effect on delay, with traffic volume having an exponential effect. These associated costs may be higher than previously estimated, especially for high traffic volumes. Based on RTC simulations, the estimated cost of direct waste due to these mainline delays is approximately \$37 million per year for US Class I railroads. Although train delay costs due to ISFs are not often considered in economic analyses of ACMT systems, they are substantial in comparison to the track and equipment damages associated with derailments (Chapter 2). Another factor not often considered is the large variability in train delay at high traffic volumes. When variability increases, there is a higher probability that more trains will experience longer delays, resulting in indirect waste in the form of increased time buffers. Although the costs due to variability are more difficult to quantify, this negatively affects the level of service that railroads can offer their customers. Therefore, additional failure costs associated with train delay can be recovered by improving railcar inspection and maintenance practices and reducing the likelihood of equipment-caused mainline ISFs.

CHAPTER 7: MACHINE VISION CONDITION MONITORING OF HEAVY-AXLE LOAD RAILCAR STRUCTURAL UNDERFRAME COMPONENTS

(In Press, Proceedings of the Institution of Mechanical Engineers, Part F: Journal of Rail and Rapid Transit, 2010)

7.1 Introduction

There are approximately 1.6 million freight cars (wagons) operating in the North American railroad network and they are subject to wide ranging forms of wear and damage while in service (AAR 2008). The United States Department of Transportation (US DOT) Federal Railroad Administration (FRA) regulations require a car inspector or train crew member to inspect every car placed in a train before that train may depart from a yard or terminal (US DOT 2008). The current railcar inspection process is tedious, labor intensive, and relies on personnel with varying degrees of experience and training who must perform their tasks under a wide range of environmental conditions. Additionally, there is currently no practical means of recording and retaining inspection information unless a billable repair is required. This makes it difficult to track the condition of an individual railcar's components over time, thereby preventing trend analyses and predictive maintenance. As a result, US railways have progressively moved away from reactive maintenance to planned and scheduled component replacement in order to improve efficiency and reduce costs (Lundgren and Killian 2005). Consequently, the Association of American Railroads (AAR) and the Transportation Technology Center, Inc. (TTCI) initiated the Advanced Technology Safety Initiative (ATSI) and a program called Technology Driven Train Inspection (TDTI) to develop and implement automated inspection technologies (Hawthorne et al. 2005, Tournay and Cummings 2005, and Robeda and Kalay 2008).

The objective of ATSI and TDTI is to provide safer, more efficient, and traceable means of rolling stock inspection by automating the mechanical inspection process through a variety of technologies. Examples of these technologies include wheel impact load detectors (WILDs),

truck (bogie) performance detectors (TPDs), acoustic bearing detectors (ABDs), and machine vision inspection of truck components, safety appliances, and brake shoes (Hart et al. 2004, Barke and Chiu 2005, Hawthorne et al. 2005, Lundgren and Killian 2005, Ahuja and Barkan 2007, Edwards et al. 2007, Freid et al. 2007, Hart et al. 2008, Robeda and Kalay 2008, Ouyang et al. 2009, and Railway Age 2009). The plan for TDTI is to implement an integrated network of automatic wayside (lineside) systems capable of inspecting and monitoring the North American freight car fleet with two principal objectives. The first goal is to cost-effectively maintain compliance with FRA regulations and railroad-specific maintenance and operational standards and the second is to improve the overall effectiveness and efficiency of the railcar inspection and maintenance process.

In order for TDTI to provide substantial improvement to the inspection process, each component and system on the railcar must be addressed. If not, railcars and trains will still need to stop in order to manually inspect the components excluded from automated inspection. An automated system that only addresses a limited selection of inspection tasks, or only inspects certain cars, would offer incremental and qualitative benefits, but it may not provide sufficient savings to cost justify the investment in these expensive technologies (Ouyang et al. 2009). Consequently, the final wayside inspection systems should be comprehensive in scope, inspecting as many aspects of the car as possible (Railway Age 2009). In addition to the wide variety of components requiring inspection, there are also many variations in the nature of component defects, symptoms of interest, and the required means of ascertaining component condition. As a result, the requisite technologies capable of addressing these inspection demands must vary in design and application. The AAR has initiated research and development on a variety of different automated inspection technologies that will address many aspects of the

federally mandated freight car inspections including brake application and release verification, brake shoe thickness measurement, safety appliance condition inspection, wheel defect inspection, and wheel profile measurement (Lundgren and Killian 2005, Robeda and Kalay 2008, and Hart et al. 2004).

7.2 Background

7.2.1 Structural Underframe Components

One component of the TDTI initiative is the development of a system known as Automated Inspection of Structural Components (AISC) that will use cameras and computer-aided image-search methods to inspect freight car underframes. Steel structural underframe components contribute to the structural integrity of the railcar by supporting the car body and lading and transmitting longitudinal buff and draft forces (slack action) within the train. On many types of freight cars the principal structural member of the underframe is the center sill, extending longitudinally along the center from one end of the car to the other. The center sill is the largest element in the underframe structure, supporting vertical loads and also transmitting the majority of buff and draft forces through the car (Kratville 1997). In addition to the center sill, several other components are needed to support vertical, longitudinal, static, and dynamic loads while the car is in transit. These components include sidesills, body bolsters, and crossbearers. Some cars also have smaller cross members (sometimes called crossties) and smaller longitudinal members known as stringers or floor supports. Unlike other underframe structural members, neither crossties nor stringers bear substantial loads. The sidesills are longitudinal members running along each side of the car. They are connected to the center sill by various cross members that run transversely from the sidesills to the center sill. The two body bolsters are the largest of these transverse members and are located near each end of the car.

Besides their role as major transverse members of the underframe structure, they support the car body atop its trucks (bogies). Crossbearers (and crosssties) are additional transverse members connecting the sidesills to the center sill and further help to distribute and support vertical loads. All of these components combine to form a structural system that maintains the car's camber and structural integrity.

7.2.1.1 Structural Underframe Defects

Freight car structural underframe components are subject to cyclic loading, shock, and vibration while in service. Cyclic longitudinal loading, also called slack action, occurs in the form of buff and draft forces. The majority of these forces are absorbed by a car's draft system, but extreme loading in buff (compression) or draft (tension) must be absorbed by the center sill and the accompanying structural components. Lateral cyclic loading occurs in curves as centripetal forces generate higher loads on one side of the railcar. A portion of these loads are carried by the sidesill and transferred to the center sill through the crossbearers. Damage and repeated loading and unloading can lead to fatigue-crack growth and ultimately result in fracture of structural members. When cars are overloaded or loaded unevenly, cyclic forces en route are higher, exacerbating fatigue stresses. In addition to cyclic loading, railcars are also subject to periodic "shocks" as a result of loading or coupling practices or track geometry deviations, which can lead to structural component defects. Examples may include: dropping lading into a gondola car rather than slowly lowering it or excessive coupling impact speeds during switching or classification yard operation. Due to these potential sources of structural component damage, the FRA and railroad mechanical department practices require railcar underframes to be regularly inspected to ensure the safe and efficient operation of rolling stock.

7.2.1.2 Structural Underframe Inspection

Due to the robust nature of railcar designs, frequent inspections, and AAR mechanical standards, serious problems with the structural elements are unusual and failures are rare. However, when failures do occur, they pose a high risk of causing a derailment. As a result, FRA mechanical regulations require the inspection of center sills for breaks, cracks, and buckling, and the inspection of sidesills, crossbearers, and body bolsters for breaks, as well as other selected inspection items (US DOT 2008). To detect defects in all of these structural elements with certainty, a car inspector must walk around the entire car, carefully looking beneath it (often with the aid of a flashlight) to adequately view each structural component. North American freight trains average approximately 70 cars in length (AAR 2008) and are often over 100 cars long. Each car typically receives about 1-2 minutes for either in-bound or outbound mechanical inspections. Under these conditions, defects that are not easily seen may go undetected. Cars are typically inspected with the level of scrutiny necessary to detect structural component problems only when entering a railcar repair shop for major repairs. Machine vision technology for inspection of underframe components offers the possibility for inspections to be performed more efficiently and effectively, hence the rail industry's interest in development of the AISC system.

7.2.2 Machine Vision Technology

A machine vision system acquires data using digital cameras, organizes and analyzes the images using computer algorithms, and produces useful information, such as the type and location of defects. Machine vision algorithms use visual cues to locate areas of interest on the freight car and then analyze each component to determine its variance from the baseline case (Lundgren and Killian 2005, Barke and Chiu 2005, and Hart et al. 2004). AISC will work

collectively with other automated systems, leading to railcar inspections that are more efficient, effective and objective than current human-vision inspections. By storing digital inspection data, it will be possible to maintain historical health records for each car that undergoes inspection. Maintaining these records will enable condition monitoring of structural elements over time, allowing the repair of defects or damaged components to be appropriately scheduled prior to an in-service failure. As a result, applying machine vision technology to the railcar inspection process has the potential to enhance rolling stock maintenance efficiency and safety.

A primary benefit of machine vision and other automated inspection systems is the facilitation of predictive, or condition-based, maintenance. Condition-based maintenance (CBM) involves monitoring certain parameters related to component health or degradation and taking corrective action prior to component failure (Lagnebäck 2007). Despite the advantages of CBM, current railcar structural component repair and billing practices encourage reactive maintenance to correct extant defects, rather than prevention of incipient failures. One of the reasons for this is the lack of cost-effective technology and infrastructure to conduct thorough inspections of many railcar elements, especially underframes. Due to the reactive nature of corrective maintenance, repairs cannot be effectively planned, resulting in higher maintenance expenses and less efficient repairs. For example, it is more economical to patch a cracked crossbearer before it breaks than to replace a fully broken crossbearer. Having recognized the need for CBM, railroads have begun implementing other technologies similar to AISC that monitor various indicators of railcar component health (e.g. TPDs and the AAR's Fully Automated Car Train Inspection System - FactISTM) (Barke and Chiu 2005, Tournay and Cummings 2005, and Ouyang et al. 2009).

7.2.3 *Previous Machine Vision Research*

Among the earliest research and development in North America on the use of machine vision for railroad inspection tasks was the work conducted by Conrail who developed a system to detect low-hanging air hoses in the 1990s (Steets and Tse 1998). Since then, research on use of machine vision for a variety of other railroad inspection tasks has been conducted, including work sponsored by the AAR, FRA, BNSF Railway, US DOT Region V Regional University Transportation (i.e. NEXTRANS) Center, and the Transportation Research Board (TRB) High-Speed Rail IDEA Program (Hart et al. 2004, Lundgren and Killian 2005, Ahuja and Barkan 2007, Berry et al. 2007, Edwards et al. 2007, Freid et al. 2007, Lai et al. 2007, Berry et al. 2008, Hart et al. 2008).

The University of Illinois at Urbana-Champaign (UIUC) has conducted several railroad machine vision research projects that have been an interdisciplinary collaboration between the Railroad Engineering Program in the Department of Civil and Environmental Engineering and the Computer Vision and Robotics Laboratory at the Beckman Institute for Advanced Science and Technology. The first of these was a project investigating wayside inspection of railcar truck components (Hart et al. 2004). The experimental setup used a perpendicular view of the truck with respect to the track, and algorithms were developed to both detect the locations of brake components and spring sets and identify missing bearing end cap bolts. This research provided a basis for subsequent research on the Automated Safety Appliance Inspection System (AS AIS) (Edwards et al. 2007). AS AIS detects deformed ladders, handholds, and brake wheels and uses visual learning techniques to determine the difference between FRA defects needing immediate attention and deformations that are less critical. The results and methods developed

in these projects have been incorporated into the AAR's TDTI program and are currently being developed by technology companies and adopted by railroads for field testing.

Subsequent UIUC research demonstrated the feasibility of using machine vision to detect defects and other anomalies on the underbodies of passenger cars and locomotives (Freid et al. 2007, Ahuja and Barkan 2007, Hart et al. 2008). Image acquisition and machine vision techniques were developed to record images and inspect rolling stock and locomotive undercarriages. Algorithms using images captured in both the visible and the infrared spectra demonstrated that missing, damaged, or overheated components could be detected as well as incipient failures and foreign objects beneath the cars. Videos of trains were recorded as they moved over a stationary camera mounted between the rails in a repair pit beneath the tracks. The combination of information from both the thermal and the visible spectra identified certain defects that might have otherwise gone unnoticed by human inspectors in the course of routine visual inspections. This research addressed some of the problems associated with acquiring images from beneath a railcar: an inherently challenging location due to lighting requirements, space constraints, and difficulties involved with keeping the equipment clean and protected. Hardware, algorithms, and technical methodologies for image acquisition developed in these earlier projects were adapted and expanded to develop a system for machine vision inspection of freight car underframes in the AISC project described in this article.

7.2.4 Regulatory Compliance

The FRA regulations for freight car inspection formed the basis for determining which components would be inspected by AISC. Section 215.121 of Title 49 in the U.S. Code of Federal Regulations (CFR) governs the inspection of freight car bodies and two of the six parts in this section pertain to the inspection of structural components (US DOT 2008b). According to

the FRA regulations, the center sill may not be broken, cracked more than 15.24 cm (6 in), or bent/buckled more than 6.35 cm (2.5 in) in any 1.83 m (6 ft) length. Specific parameters are established for the allowable magnitude of cracks and buckling because these defects may undermine the integrity of the center sill, resulting in a failure (US DOT 2008b). Therefore, these regulations are intended to identify potentially hazardous cars so that they will be repaired before an in-service failure. During FRA motive power and equipment (MP&E) inspections, inspectors have multiple enforcement options. The inspector may take exception to the condition of a structural component and issue a warning to the operating railroad of possible monetary penalties if the defect is not repaired immediately. When deemed necessary, inspectors can also issue violations having monetary penalties ranging from \$2,500 to \$6,000 depending on the type, severity, and location of the defect (US DOT 2008b).

7.2.5 Research Focus

In order to determine which structural elements should have the highest priority among AISC inspection tasks, railcar inspection data from the FRA Office of Safety were analyzed for the time period of 2000 to 2007. Inspection data pertaining only to railcar underframe components were considered in this analysis. Fifty-nine percent of all structural component defects identified by FRA MP&E inspectors, were broken, cracked, bent, or buckled center sills, while the remaining 41 percent were defective sidesills, body bolsters, or crossbearers (Figure 7.1).

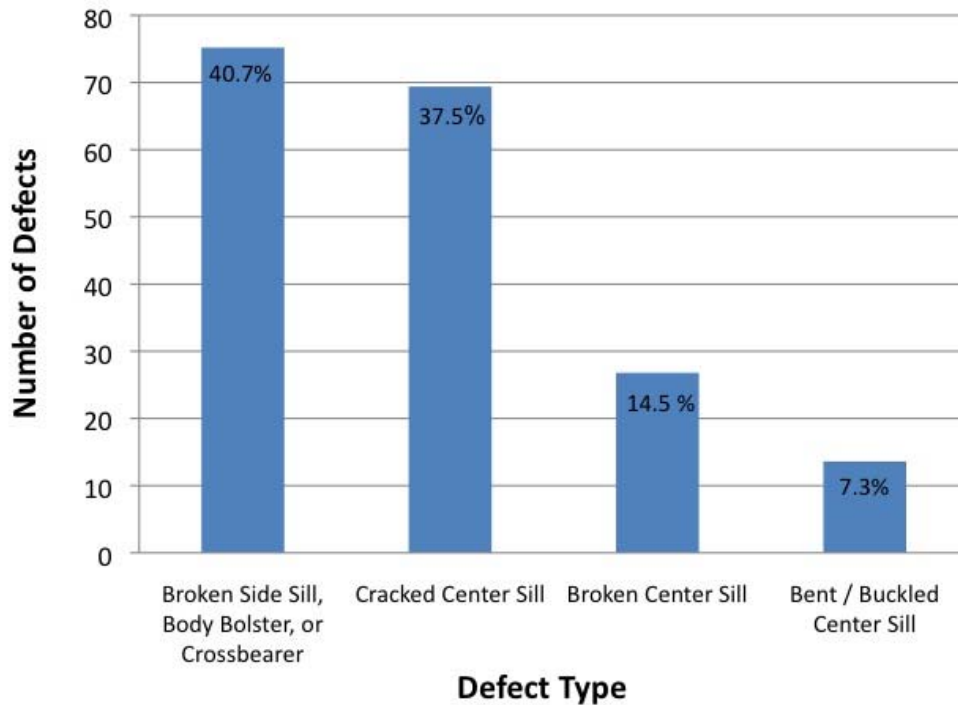

Figure 7.1 Average Number of Annual Structural Underframe Defects Recorded by FRA MP&E Inspectors (2000-2007)

These data suggest that defects in the center sill are the most frequent type among freight car structural underframe components. This is consistent with FRA train accident data from 1999 to 2008. Over this 10-year period, bent or broken center sills were responsible for 75 train accidents on US Class I railroads in comparison to only 31 accidents due to broken side sills and only one accident due to a defective body bolster (US DOT 2009). Given the importance of center sills in providing load bearing capacity and their role in transmitting buff and draft forces, the consequence of center sill failures are higher than other structural components. Fines assessed by FRA inspectors due to a broken center sill are among the highest of those listed in CFR 215.121, matched only by violations due to loose or broken axles. Risk is typically defined as the product of frequency (or probability) and consequence (Glickman and Gough 1990). Center sill defects are more frequent and have higher consequences than other structural

components, thus the risk associated with center sill failure is the highest among railcar structural components. Therefore, the inspection of center sills is a primary focus of AISC and of this research.

7.3 Methodology

7.3.1 Preliminary Image Acquisition

The initial stage of this research focused on collecting images of representative railcar structural components. Preliminary tests were conducted at the Monticello Railway Museum in Monticello, IL on a 1950-era AAR-standard-design hopper car. The basic data recording system was adapted from UIUC's previous passenger car inspection research (Freid et al. 2007, Ahuja and Barkan 2007, Hart et al. 2008). Camera and lighting equipment were mounted, facing upward, on the floor of a three-foot-deep inspection pit, and connected to a laptop computer adjacent to the pit. Eight halogen lights were arranged in a circle with the camera in the center and were manually adjusted in order to provide proper illumination of the railcar's center sill. Experiments were conducted in which the car was rolled over the pit track at various speeds, and images were recorded under various levels of light intensity. A panoramic image was developed using image data from the best (i.e. most clearly visible) trial. Using previously developed panoramic image creation algorithms, the central portions of each consecutive video frame were extracted and appended together to form a complete image of the entire railcar underbody (Freid et al. 2007) (Figure 7.2).

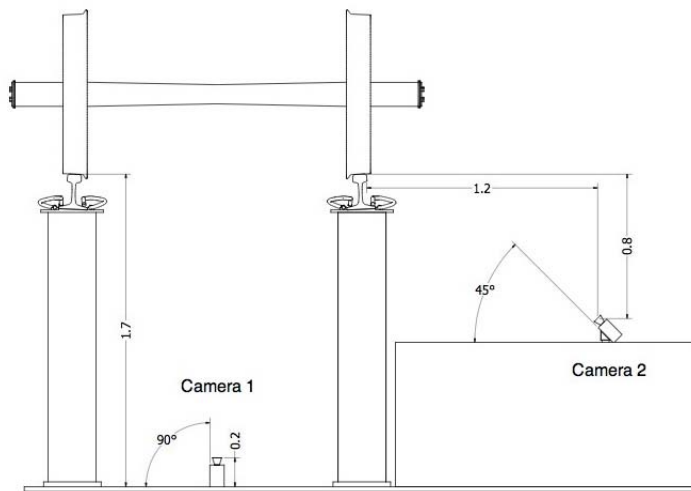

Figure 7.2 Panorama of Hopper Car Underframe Using Preliminary Image Acquisition Methods

The resulting panorama provided initial confidence in the feasibility of this method of automated structural component inspection. Several critical structural underframe components, including the center sill and crossbearers, are clearly visible in the panoramic image as well as other mechanical components such as the couplers, draft gear, truck bolsters, brake rigging, brake beam, interior springs in each spring nest, and axles. Results from these tests identified specific areas for improvement, including better illumination of the recessed portions of the underframe most distant from the camera (e.g. the tops of the hoppers).

7.3.2 Data Collection

After analyzing preliminary image acquisition results, a more precise experimental setup was developed using an additional camera (Figure 7.3a), and data collection procedures were defined. This equipment arrangement was used during testing at the Norfolk Southern (NS) locomotive repair facility in Decatur, IL (Figure 7.3b).



(a)



(b)

Figure 7.3 Diagram of Equipment Setup With Measurements in Meters (a) and Locomotive Repair Pit Used for Data Collection (b)

The test set-up included two cameras placed below the rails. In an arrangement similar to the setup used at Monticello, Camera 1 was located 1.65 m (65 in) below the top of rail, centered between the two rails and aimed straight upward, 90° from horizontal (Figure 7.3a). The video-image collection system for this camera view was a Dragonfly 2 camera recording at 15 frames per second, with a 4.8mm lens and an f/1.8 aperture. Illumination was provided by eight 575W (115V) halogen lights, each with parabolic reflectors and medium flood lenses. The lights were oriented on the floor of the pit in a circle around the camera, and the intensity of each light could be individually adjusted. Using a handheld light meter, the maximum luminous intensity of each light was determined to be 40,900 lx (3,880 foot candles at a distance of 3 ft.). The lights were aimed upward but adjusted inwardly at various angles to provide even illumination of the camera's entire field of view. Half of the lights were oriented to illuminate the center sill, whereas, the other four lights were positioned at higher angles (closer to 90° vertically) in order to illuminate the more distant portions of the underbody (i.e. the top sections of the hoppers).

Camera 2 was positioned 1.22 m (48 in) from the field side of the rail, 0.76 m (30 in) below the top of rail, oriented perpendicular to the track and aimed upward 45° above horizontal (Figure 7.3a). Equipment for this camera view included a Marlin camera recording at 15 frames per second and a 6mm lens with an f/1.4 aperture. Four individually adjustable halogen lights (with the same specifications as those used for Camera 1) provided illumination for Camera 2, each oriented at approximately 45 degrees above horizontal. Tests were run using two NS gondola cars and one NS covered hopper car by rolling them past the cameras at 5-8 km/h (3-5 mph). Fourteen different videos were recorded during testing, and the image data were converted into panoramic images (Figure 7.4). Since the two gondola cars were almost identical to each other, images of only one of the cars are shown.

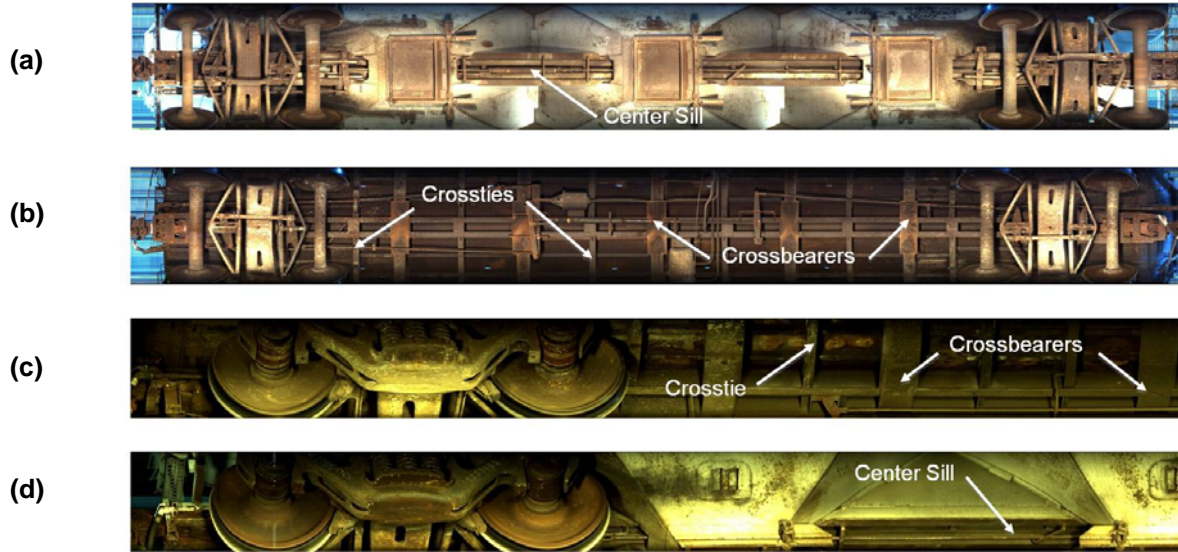

Figure 7.4 Panoramic Images of Hopper Car (a & c) and Gondola Car (b & d) From Camera 1 (a & b) and Camera 2 (c & d)

Results from the testing at Decatur show much more even illumination for the covered hopper car image (Figure 7.4a) compared to the previously recorded hopper car panorama (Figure 7.2). The panorama of the gondola underbody (Figure 7.4b) provides a clear view of the center sill, crossbearers and crossies (thinner lateral members between the crossbearers). Other components of the gondola that are clearly visible include the brake reservoir, brake cylinder and the entire foundation of the braking system. In order to determine the resolution of the panoramic images, engineering drawings were acquired from NS for each of the cars that were tested. By measuring certain components in the panoramic image in pixels and dividing by the actual lengths of those components, the pixel-to-cm ratio (i.e. the image resolution) was determined to be 3.03 pixels per centimeter (~7.8 pixels per inch). Each panoramic image was developed by combining the center strips of over 400 video frames, with each strip having a mean strip size of approximately 12 pixels.

The panoramas from Camera 2 are much longer due to the fact that this camera was located closer to the track than Camera 1. As a result, the images in Figure 7.4c and 7.4d only represent one half of each railcar. The images from this camera view are valuable because cracks or breaks in the side of the center sill would be visible from this angle. This view can also be used to inspect the camber of the car, to determine whether the center sill is sagging or deformed.

7.4 Data Analysis

7.4.1 Multiscale Image Segmentation

Given a panoramic image of the car underframe, algorithms must detect and localize the center sill in the image and inspect it for two types of defects: (i) deformation caused by bending and/or buckling and (ii) the presence of breaks or cracks. The nature of the two types of defects being considered necessitates the development of a multiscale analysis approach, where defect search functions are performed at various scales, or levels, of image segmentation. The area occupied by the center sill differs significantly in size compared to the area encompassing a crack. As a result, the detection of the center sill requires analysis of large pixel neighborhoods, whereas, the detection of breaks and cracks requires analysis of higher-resolution image details. A computationally efficient strategy capable of addressing these two image-analysis extremes is known as multiscale image segmentation (Ahuja 1996, Tabb and Ahuja 1997, Arora and Ahuja 2006). Multiscale image segmentation provides access to pixel neighborhoods of varying size, which can be further used for detection and inspection of the center sill for defects.

The machine vision algorithm requires the following steps:

1. Using pixel values present in the image, parse the panorama into homogeneous-intensity regions at all degrees of inter-region versus intra-region homogeneity.

2. Analyze regions obtained at the coarsest scale (showing limited detail) to detect the center sill by using a known model (e.g. a rectangular shaped object located at the center of the panoramic image).
3. Inspect the contours of the image regions that identify the center sill to measure their deviation from the model, thus determining the degree of center sill bending and/or buckling.
4. Recursively analyze sub-regions at different scales of the segmentation, from fine to coarse, to detect cracks or breaks in the center sill. Use models developed from example images containing cracks or breaks (e.g. a crack typically appears in the image as an elongated, dark region that represents a discontinuity in brightness).

This recursive analysis is feasible due to the multiscale image-segmentation algorithm previously developed at UIUC and noted in step one (Ahuja 1996, Tabb and Ahuja 1997, Arora and Ahuja 2006). In this case, object detection immediately produces object segmentation since region boundaries generally coincide with boundaries of an object present in the image (i.e. detection of the center sill in step 2 simultaneously delineates its boundaries, and thus localizes its position in the image). Similar to center sill detection, the identification of cracks and breaks in the center sill is based on models of these defects. Identification of a crack or break simultaneously localizes its position, orientation, and length, and this information can be used to evaluate the magnitude of the discovered defect.

The segmentation algorithm partitions the image into homogeneous regions of previously unknown shape, size, gray-level contrast, and topological context. A region is perceived to be homogeneous if variations in pixel intensity within the region are smaller than intensity

variations of its surroundings, regardless of its absolute degree of variability. Consequently, image segmentation may be performed at a range of homogeneity values (Figure 7.5).

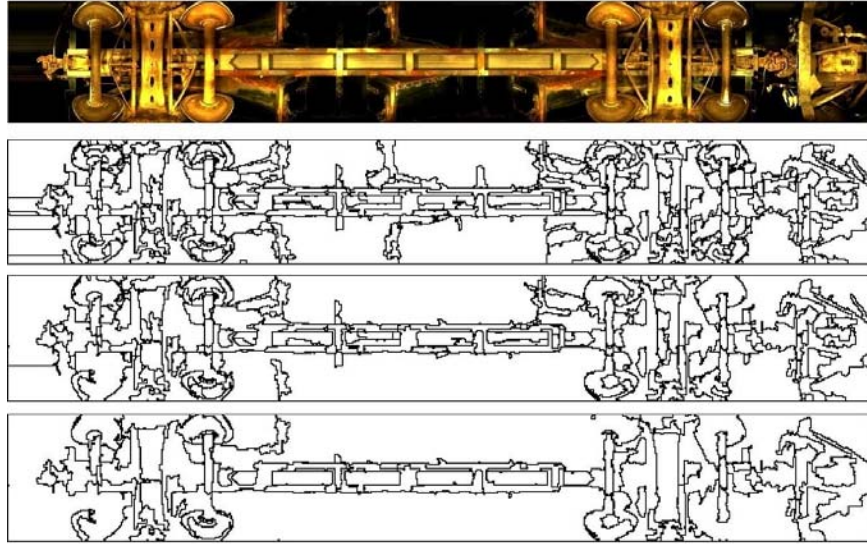

Figure 7.5 Multiscale Segmentation Hierarchy of Hopper Car Image Showing Car Underframe With the Segmentation Scale Increasing (i.e. Becoming More Coarse) From Top to Bottom

At any scale, recursive segmentation may be performed to extract finer scale segments characterized by an increasing degree of homogeneity. This process continues until one obtains strictly constant intensity regions, yielding a multiscale segmentation of the image. The black pixels form the boundary lines of the segmented regions. As the scale increases, smaller regions strictly merge to form a larger region, meaning that the segmentation algorithm is hierarchical. The same multiscale segmentation algorithm can also be used for simultaneous inspection of other structural components in addition to the center sill. For example, analyzing the image segmentation at a finer scale than that used for center sill inspection, crossbearers can also be inspected for breaks, cracks, bending, and buckling.

7.4.2 Center Sill Inspection

The center sill is the largest and single most critical structural component in the railcar underbody; therefore its correct identification and inspection is the highest priority of the AISC inspection tasks. The consistency of the camera orientation and panorama development techniques allow one to hypothesize that the center sill: (1) is centrally located in the corresponding panorama, (2) appears as a rectangle with possible embedded patterns within the rectangle, and (3) contains two long parallel edges that lie along two horizontal image rows. Therefore, the center sill can be modeled as a large, rectangular-shaped object, prominently featured at the center of the panoramic image. A template is developed based on the model parameters above or made from averaging templates created from panoramic images from cars of the same type. Then, starting with the coarsest levels of the segmentation hierarchy, the template is matched to the segmentation image to find the central location of the center sill between the wheelsets (Figure 7.6a).

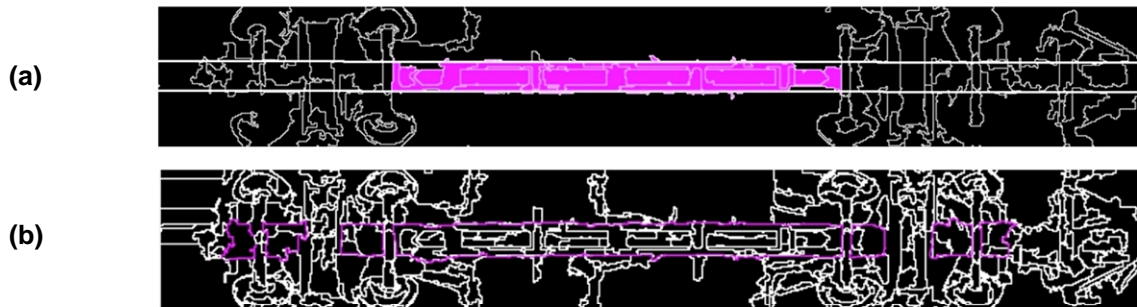

Figure 7.6 Center Sill Detection Using the Coarsest-Scale Segmentation (a) and Center Sill Boundary Identification Using Finer Scale Segmentation (b) (Colors Have Been Modified for Document Reproduction Purposes)

Once identified, the matching edges are interpreted as contours of the center sill. These identified edges also indicate the general direction in which the center sill extends across the image. However, some parts of the center sill (e.g. the portion above the truck bolster) are

partially occluded, and other parts appear in the cluttered areas around the railcar truck (bogie). These parts cannot be directly detected using the aforementioned strategy. Therefore, the detected edges must be used to guide an additional search for the remaining portions of the center sill. It is assumed that the amount of possible deformation of the partially occluded parts is relatively small, so these portions of the center sill should occur in the vicinity of the previously identified general direction of the sill. The remaining visible parts can then be detected by analyzing a finer-scale segmentation and identifying the edges that lie along the general direction of the center sill. Nearby segmentation boundary pixels are identified to fill in missing parts of the center sill contour (Figure 7.6b).

Given that the camera view is along the surface perpendicular to and directly below the center of the car, the known physical width of the center sill in the scene can be immediately mapped to the number of pixels associated with this width in the image. This mapping technique serves to calibrate the measurement of deformation of the center sill in the image. The average error of identified contours of the center sill using multiscale segmentation is two pixels, which corresponds to about 0.66 cm (one pixel corresponds to 0.33 cm, or 0.13 in). Improved camera resolution should further reduce this error. Additional errors could be generated by lateral motion of the train when passing the AISC system. These errors were not witnessed during testing, however, they could be remedied, should they prove to be a problem. By maintaining a tight track gauge and using guardrails that force the wheel flange against the gauge side of the rail at the inspection site, lateral motion could be substantially reduced or eliminated.

7.4.3 *Pixel Summation*

An alternative, less computationally intensive method can also be used to find the location of the center sill. This method, based on pixel summation, is carried out by summing

the pixels longitudinally for each row of the segmented image (or edge image) of the car panorama. The number of pixels along each horizontal row is computed from the edge image (Figure 7.7a). Long, straight sections in the panoramic image will appear as prominent peaks in the histogram of the pixel summation (Figure 7.8a).

Since the center sill creates the longest edges in the panoramic image, the two largest peaks (a and f in Figure 7.8a) correspond to the outer contours of the center sill, while the four interior peaks (b - e in Figure 7.8a) in the histogram correspond to the inner contours of the center sill (see Figure 7.8b). The outer contours along the length of the center sill are then denoted with white parallel lines (Figure 7.7b and Figure 7.8b). These detected edges can then be used to guide the search for the remaining parts of the center sill as described in the previous method. Once the contours of the center sill are identified, they are compared with the ideal template. Any deviation from the parallel lines is interpreted as deformation. This method can also be applied in the lateral direction to identify and inspect crossbearers and cross ties.

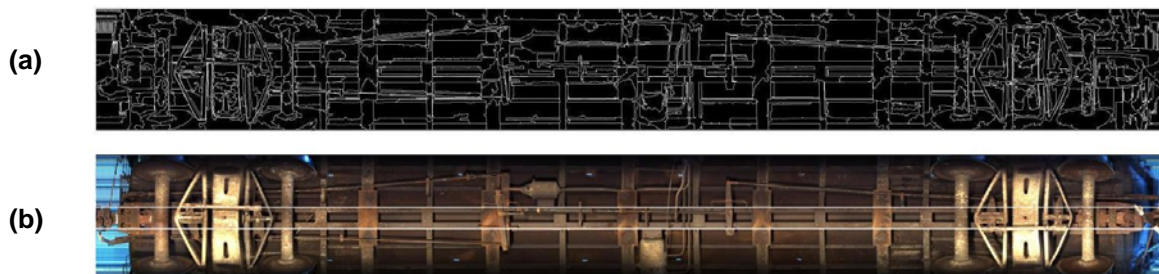

Figure 7.7 Edge Image of Gondola Car Underbody Panorama (a) and Original Panorama With Center Sill Detected (b)

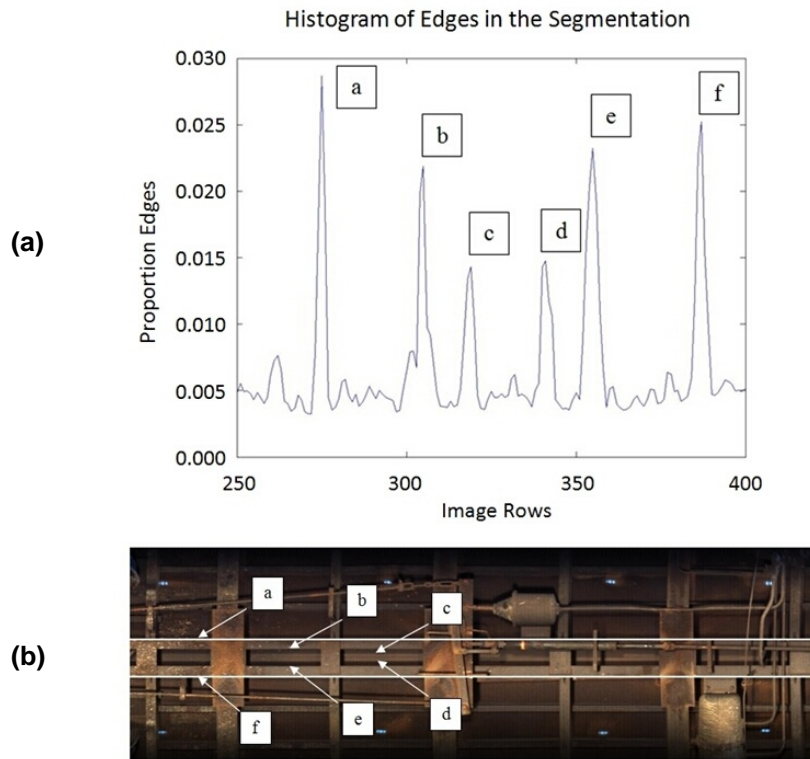

Figure 7.8 Histogram of the Pixel Summations Belonging to Center Sill Region Boundaries, With the Row Index of the Image on the Horizontal Axis and the Proportion of Strong Edges on the Vertical Axis (a); (b) is a Close-Up of Figure 7.7b, Showing the Edges (a - f) Corresponding to (a)

Additionally, using the panoramas from Camera 2 (Figure 7.4c and 7.4d), the same methods described above can be utilized to identify the location of the center sill from the side of the car. Using pixel summation, the bottom edge of the center sill can be identified and inspected for breaks or bends. As a result, the AISC system will detect whether or not the center sill maintains appropriate camber and could determine if a car has been overloaded to the point of causing the center sill to deform. Pixel summation provides detection and inspection flexibility with reduced computational requirements but does not provide the same level of accuracy or robustness as the multiscale segmentation approach.

7.4.4 *Inspection of Cracks and Breaks*

The image region identified as the center sill will be analyzed to detect the presence of cracks and breaks. This phase of work is still in preliminary stages, but a multiscale process has been proposed as a potential approach to this aspect of inspection. Both cracks and breaks can be modeled as distinct objects that may occur in the image area occupied by the center sill. A crack can be modeled as a homogeneous, elongated region that appears darker than the center sill. Similarly, a break can be modeled as a dark region that represents a discontinuity in the following properties of the center sill: brightness, contiguity of the sill's contours, and co-linearity and parallelism with parts of the center sill's contours.

The algorithm will first identify the region that delineates the boundary of the center sill (Figure 7.6a). To identify breaks and cracks, a multi-scale search strategy will be used that recursively searches smaller subregions embedded in the region occupied by the center sill. At each segmentation scale, the regions found will be compared to the models developed for breaks and cracks, identifying suspect regions corresponding to a center sill crack (Figure 7.9).

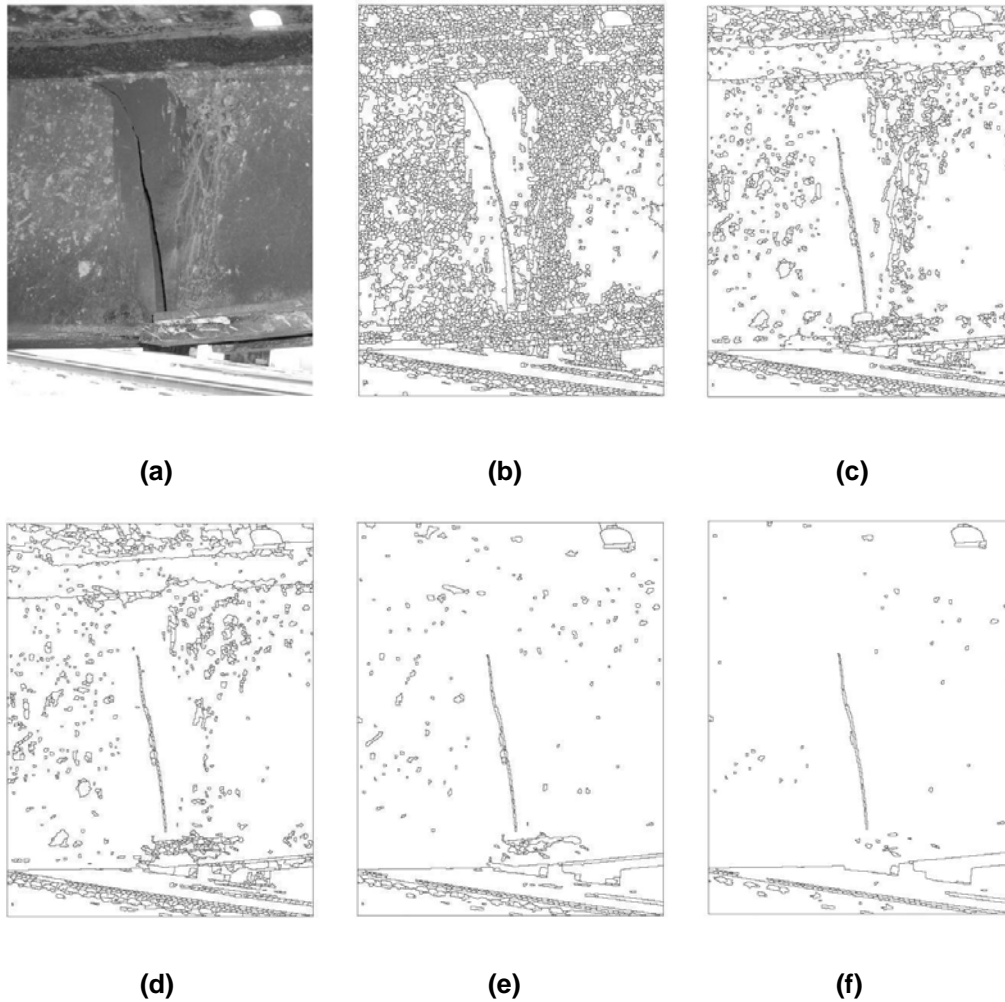

Figure 7.9 Original Digital Image of a Cracked Center Sill, Provided Courtesy of AAR (a) and Fine to Coarse Segmentation Images (b-f), Showing the Crack at Various Segmentation Levels

If any of these subregions exhibit properties defined by the models, they will be considered as potential cracks or breaks. In addition to detection, the AISC system will also be able to identify the position, orientation, length and other characteristics of cracks and breaks and thus assess the degree of damage. Since cracks, in general, appear at finer resolutions of the image, their detection is expected to be more difficult than breaks; however, preliminary field data indicate that it will be feasible.

7.5 Discussion

The ultimate goal for an automated machine vision railcar inspection system is one that can inspect railcars using a series of integrated wayside cameras, including the AISC cameras located below the track. Through automated inspections, freight cars will be inspected more thoroughly and potential risks associated with manual car inspection minimized. A completely functional AISC will be capable of inspecting the underframes of an entire train of cars moving at mainline speeds, identifying areas of concern and reporting the suspected defects to railroad inspection personnel for further review or repair at terminals ahead. After implementing algorithms for structural component inspection, AISC will provide a basis for future systems capable of addressing other mechanical component defects visible from the bottom of the car (e.g. missing knuckle pins, broken or missing coupler retaining pins and broken train line trolleys).

In addition to the goals of TDTI, there are other advantages afforded by the use of this technology. The collection of high-quality images of railcar components, even without the use of machine vision and computer-aided defect detection, can provide benefits to the railroad industry. For example, a car inspector could be stationed in an office with the task of manually inspecting the digital images of railcar underbodies, as trains pass the inspection site. If used in this manner, benefits could be immediately realized, as car inspectors would have a much clearer and more comprehensive view of railcar underbodies than is currently possible. In addition, the collection of high-quality images of railcar underframes would also be helpful for security and liability purposes, as AISC could provide railroads the ability to detect “non-standard features” including contraband or explosive devices (Lundgren and Killian 2005). These images would also provide historical documentation of railcar underbody condition that has not been previously

available. As machine vision systems develop further, software could be integrated to aid the human inspector by highlighting potential defects visible in the images. Models of humans and machines have been used to develop similar hybrid automation systems for other industries, which typically perform better than either humans or machines alone (Chi and Drury 2001 and Hou et al. 1993). In this way, railroads could benefit from the increased speed of an automated system while improving the quality of human decision making.

Finally, the use of automated inspection systems will eliminate wasted effort by allowing car inspectors to spend less time inspecting cars and dedicate more time to the value-adding task of making repairs. This will result in reduced inspection times and will potentially add capacity to receiving and departure tracks, thus improving the efficiency of an entire terminal (Edwards 2006). As a result of the benefits in terminals, these technologies may also improve overall railroad network efficiency, since average train speed and service reliability are greatly dependant on terminal dwell (Martland et al. 1992, Kwon et al. 1995, Murray 2002, Dirnberger 2006, Logan 2006, Dirnberger and Barkan 2007). In order to improve yard and terminal efficiency most effectively, all freight car inspection tasks will need to be automated. Since a railcar's physical features (including underframes) vary substantially among car types, extensive testing will be required to ensure appropriate inspection accuracy and minimal false alarm rates. Machine vision inspection capabilities will initially be most applicable to unit trains (i.e. those containing cars of nearly uniform design) due to the fact that component image templates (e.g. the shape of the center sill) will be consistent for the entire train. After successfully integrating this technology in unit train operations, the use of machine vision underframe inspection can then be extended to manifest trains, which contain a variety of different car types. Although a partially automated inspection system (i.e. one that still required one or more cars or components

to be manually inspected) would provide incremental benefits in effectiveness, terminal efficiency and/or labor utilization, the benefits would be disproportionately less. Therefore, the larger TDTI vision, of which AISC is a part, is being pursued by the North American railway industry.

The technical knowledge exists for the TDTI objective to become a reality, however additional work is required to develop and integrate the appropriate systems. Calibration and validation requirements will need to be determined for AISC and other machine vision systems similar to those developed for wheel impact load detectors (WILDs) and acoustic bearing detectors (ABDs) (AAR 2010d). In addition, each location where AISC is installed will require site validation, which will likely be more extensive than what is required for either WILD or ABD sites, due to the large number of disparate components that AISC will inspect. Although the validation period may be longer for AISC and other machine vision systems, these technologies will benefit from the framework that has been established for previous wayside detector implementation.

7.6 Conclusions

The image acquisition system and machine vision inspection algorithms described in this article have demonstrated the feasibility of AISC for the improvement of the effectiveness, efficiency and objectivity of railcar inspections. The initial machine vision system parameters needed to inspect and evaluate the health of railcar structural underframes have been determined and railway technology supply firms have built a subsequent test installation at TTCI. This installation currently collects images of railcar underbodies at speeds up to 64 km/h (40 miles per hour) and provides the capability to further develop and refine the AISC system for use with multiple types of freight car underframes. As a result of implementing this machine vision

technology and other automated inspection systems, railroads will be poised to improve inspection effectiveness, take advantage of the operation and management benefits of predictive maintenance strategies and improve system-wide network reliability and efficiency.

CHAPTER 8: CONCLUSIONS AND FUTURE RESEARCH

8.1 Conclusions

The objective of this thesis was to determine the safety and economic impacts of implementing ACMT in the US railroad industry. I identified three potential areas of cost savings for the railroads, driven by the goal of improved railcar condition monitoring (Figure 1.2). The total potential cost savings for each area are summarized in Figure 8.1. The purpose of these analyses was to understand the magnitude of ACMT cost benefits and to develop methodologies for estimating these costs. Although detailed cost-benefit analyses will be required to develop more accurate, industry-wide estimates for each of these areas of cost savings, individual railroads can use the methods developed in Chapters 2, 5, and 6 to estimate the cost savings specific to their company.

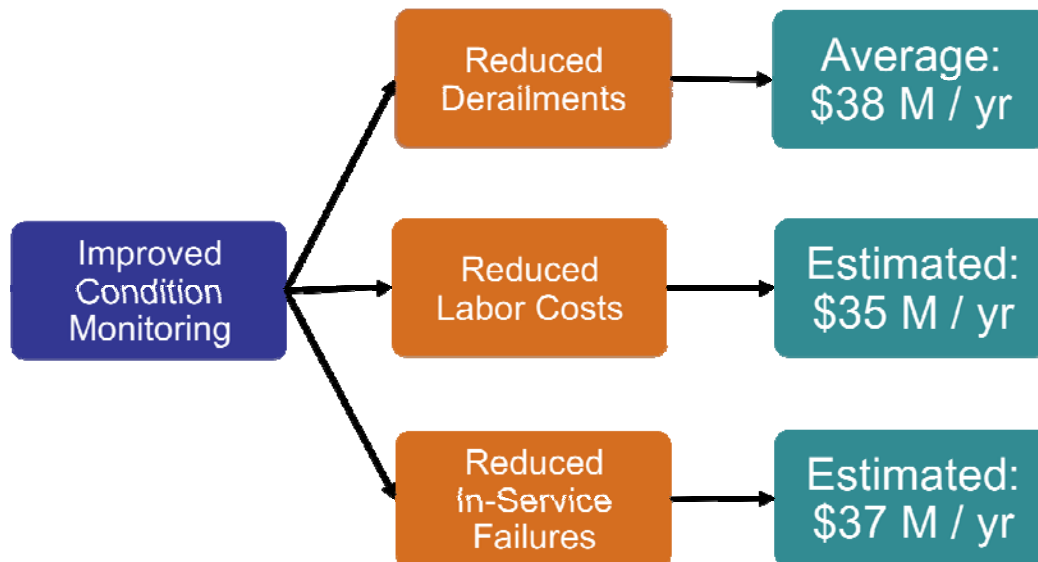

Figure 8.1 Maximum Estimated Annual Cost Savings due to the Implementation of ACMT for the US Railroad Industry

8.1.1 *Reduced Derailments*

Based on analysis of FRA accident data from 1999 to 2008, reportable equipment-caused mainline derailments lead to approximately \$38 million per year in track and equipment damages

for the four largest US Class I railroads. Thus, the potential savings from ACMT implementation will be a portion of this value. The extent to which ACMT can reduce the likelihood of derailments will be an important area of future research.

8.1.2 Reduced Terminal Dwell

The second area of potential cost savings is the reduction in labor costs associated with manual railcar inspection. Using ACMT to augment manual inspections, I estimated that the US railroad industry could save over \$35 million in labor costs per year through the reduction of direct operational waste. Additional cost savings would result from implementing lean production techniques such as managing buffers more efficiently and reducing variability in yard operations.

8.1.3 Reduced In-Service Failures

By increasing the effectiveness of condition monitoring, railcar components can be maintained more efficiently, resulting in fewer mainline ISFs. A survey of the Class 1 railroads indicated that approximately 23,000 ACMT detectable ISFs occur per year. Based on RTC simulation data and assuming a constant delay cost per hour, I estimated that equipment-caused mainline ISFs result in approximately \$37 million in delay costs per year. However, this is probably an underestimate due to limitations in the data. As with the cost savings due to derailment reduction, the actual savings will be some portion of this value, determined by the distribution of specific causes of ISFs and the relative effectiveness of ACMTs to prevent particular causes of ISFs.

8.2 Future Research

8.2.1 Railcar Component Risk Metric

To effectively estimate the potential cost savings of ACMT, a framework must be

developed to associate derailment and/or ISF risk with component condition. One means of doing so would be to develop a risk metric for each FRA equipment-related (Group E) accident cause code. For example, the cause code for a broken wheel rim (E61C) would have a much higher risk metric value than the cause code for an open boxcar door (E83C). This metric would need to be a function of both the historical frequency in which a given cause code was responsible for causing a derailment or ISF and the severity of those incidents (e.g. the number of cars derailed). These data are more readily available for derailments (using the FRA accident database) than for ISFs. Incorporating the risk associated with ISFs will require data from individual Class I railroad mechanical databases. Although these data may be difficult to acquire, it would be advantageous to do so, because the cost of train delays due to equipment-caused mainline ISFs (approximately \$37 million per year) is comparable to the annual track and equipment damages of equipment-caused mainline derailments (approximately \$38 million per year). Through the use of a railcar component risk metric, it would be possible to more accurately determine the potential cost savings of implementing ACMT.

8.2.2 ACMT Inspection Accuracy

After developing a railcar component risk metric, the accuracy of ACMT must be determined in order to assess the extent to which derailment and/or ISF risk can be reduced. I provide a brief discussion of ACMT accuracy in Chapter 5 (Section 5.3.3) but only general estimates of correct identification and false alarm rates were possible given the data. In order to develop more precise estimates for the potential cost savings of ACMT, a more rigorous analysis will need to be performed to determine the true correct identification and false alarm rates for current ACMT. Since some technologies are still in development, the data are still insufficient to estimate their long-term, operational accuracy. As railroads continue to install ACMT and

collect more field data, it will be possible to develop better estimates of system accuracy.

8.2.3 Terminal Efficiency

To better understand the potential operational waste associated with railcar inspection practices, the entire railcar maintenance process should be studied. This will involve identification of each individual inspection sub-process and determination of the value and/or waste associated with each. Value stream maps (Dirnberger 2006) can be developed and time-in-motion studies performed in terminals to identify and quantify operational waste. Variability in the railcar maintenance process can also be addressed and methodologies developed to reduce variability using Statistical Process Control (SPC) and Six Sigma techniques. As Lean Railroading methods are further developed and refined for unit train operations, these methods can also be applied to other areas including intermodal trains, and more specifically, intermodal terminals. Intermodal traffic is expected to continue to grow over the next several decades, and the impact of intermodal terminal operations on network capacity and efficiency will become even more important. Applying lean production methods to these terminals could result in substantial cost savings in terms of reduced labor, terminal dwell and operational variability.

8.2.4 Additional Derailment Costs

Another area of future research is the quantification of train delay costs due to major derailments. For longer mainline service outages (e.g. 24 to 48 hours), it was impractical to perform RTC simulations due to the amount of time and computational resources required. In addition, due to the rerouting that occurs and other complexities that accompany major derailments, actual train delay costs cannot be easily estimated using either linear or exponential estimation methods. Other costs that could be included in this analysis are environmental clean-up and litigation costs associated with equipment-caused derailments. These costs, in addition to

train delay costs, could vary substantially, so the best approach may be to use an empirical analysis with historical derailment data.

8.2.5 Additional Cost of ACMT Implementation

Finally, future research may also include assessing additional costs associated with the implementation of ACMT. Beyond the cost of purchasing, installing and maintaining the physical ACMT systems, other costs include: building electronic infrastructure, incorporating institutional changes (e.g. developing company policies regarding system operation, maintenance, and integration with railcar inspection and repair practices), and performing additional railcar maintenance afforded by improved inspection effectiveness. A thorough analysis of both the costs and benefits of improved railcar condition monitoring will provide railroads with the tools necessary to make informed decisions regarding the implementation of ACMT.

REFERENCES

- Aldrich, M. (2006). *Death Rode the Rails – American Railroad Accidents and Safety 1828-1965*. Johns Hopkins University Press: Baltimore.
- Ahuja, N. and C. P. L. Barkan (2007). Machine Vision for Railroad Equipment Undercarriage Inspection Using Multi-Spectral Imaging – HSR 49. Final Report. High-Speed Rail IDEA Program, Transportation Research Board, National Research Council, Washington, DC, 2007, <http://144.171.11.40/cmsfeed/TRBNetProjectDisplay.asp?ProjectID=2419>, [8 November 2009].
- Ahuja, N. (1996). A transform for multiscale image segmentation by integrated edge and region detection. *IEEE Trans. Pattern Anal.*, 1996, vol. 18, no. 12, pp. 1211–1235.
- Anand, P., C. P. L. Barkan, D. J. Schaeffer, C. J. Werth, and B. S. Minsker (2005). Environmental risk analysis of chemicals transported in railroad tank cars. In Proceedings of the 8th *International Heavy Haul Conference*, Rio De Janeiro, June 2005, pp. 395-403.
- Arora H. and N. Ahuja (2006). Analysis of ramp discontinuity model for multiscale image segmentation. *Proc. Int. Conf. Patt. Recog.*, 2006, vol. 4, pp. 99–103.
- Association of American Railroads (AAR) (2008). *Railroad Facts*, Association of American Railroads, Washington, DC, 2008.
- Association of American Railroads (AAR) (2008b). *Analysis of Class I Railroads*, Association of American Railroads, Washington, DC, 2008.
- Association of American Railroads (AAR) (2008c). “Field Manual of the A.A.R. Interchange Rules. Association of American Railroads, Washington, D.C.
- Association of American Railroads (AAR) (2009). “High-Tech Advances Improve Safety & Efficiency.” Association of American Railroads, Washington, D.C., <http://www.aar.org/InCongress/BackgroundPapers.aspx>, [8 March 2010].
- Association of American Railroads (AAR) (2009b). *Railroad Facts*, Association of American Railroads, Washington, DC, 2009.
- Association of American Railroads (AAR) (2010). “Railroads: Moving America Safely.” Association of American Railroads, Washington, D.C., <http://www.aar.org/KeyIssues/Background-Papers.aspx>, [10 October 2010].
- Association of American Railroads (AAR) (2010b). “The Impact of the Staggers Rail Act of 1980.” Association of American Railroads, Washington, D.C., <http://www.aar.org/KeyIssues/Background-Papers.aspx>, [10 October 2010].

- Association of American Railroads (AAR) (2010c). "Railroad Performance Measures." *Association of American Railroads*, Washington, D.C., <http://www.railroadpm.org>, [7 May 2010].
- Association of American Railroads (AAR) (2010d). "Field Manual of the A.A.R. Interchange Rules. Association of American Railroads, Washington, D.C.
- Austin, K. B. (1949). Hotbox signal for railway trains, U.S. Patent 2486546.
- Barke, D. and W. K. Chiu (2005). Structural health monitoring in the railway industry: A review. *Structural Health Monitoring*, vol. 4, pp. 81-93.
- Berry, A., X. Gibert-Serra, D. McNew, B. Nejikovsky, and A. Tajaddini (2007). High Speed Joint Bar Inspection Using Advanced Image Collection and Processing Techniques. *In Proceedings of the American Railway Engineering and Maintenance of Way Association Annual Conference*, Chicago, IL, September 2007.
- Berry, A., D., B. Nejikovsky, A. Tajaddini and R. Gagne (2008). Implementation and Deployment of Machine Vision Technology in Rail Inspection and Maintenance. *In Proceedings of the American Railway Engineering and Maintenance of Way Association Annual Conference*, Salt Lake City, UT, September 2008.
- Bladon et al. (2004). Predictive condition monitoring of railway rolling stock. *In Proceedings of the Conference on Railway Engineering*, Darwin, 20-23 June 2004.
- Brickle, B., R., Morgan, E. Smith, J. Brosseau, and C. Pinney (2008). *Wheelset Condition Monitoring - RSSB Report for Task T607*, TTCI(UK), Ltd., July 2008.
- Bureau of Transportation Statistics (BTS) (2006). Research and Innovative Technology Administration, U.S. Department of Transportation. National Transportation Atlas Database. http://www.bts.gov/publications/national_transportation_atlas_database Accessed March 16, 2010.
- Burpee, C. M. ed. (1945). *Railway Engineering and Maintenance Cyclopedia*, 6th edn., Simmons-Boardman Publishing Company, Chicago, IL.
- Chi, C.-F. and C. G. Drury (2001). Limits to human optimization in inspection performance. *International Journal of Systems Science*, vol. 32, no. 6, pp. 689-701.
- Clark, C. H. (1966). The Railroad Safety Movement in the United States: Origins and Development, 1869 to 1893, Ph.D. Thesis, University of Illinois at Urbana-Champaign, Urbana, IL, 1966. pp. 1-387.
- Cline, J. E., J. R. Bilodeau, and R. L. Smith (1998). Acoustic wayside identification of freight car roller bearing defects. *In Proceedings of the 1998 ASME/IEEE Joint Railroad Conference*, Philadelphia, 15-16 April 1998. pp. 79-84.

- Dingler, M. H., Y-C. Lai, and C.P.L Barkan (2009). Impact of Train Type Heterogeneity on Single-Track Railway Capacity. *In Transportation Research Record: Journal of the Transportation Research Board*, No. 2117, Transportation Research Board of the National Academies, Washington, D.C., pp. 41–49.
- Dingler, M. H. (2010). Understanding the Impact of Operations and New Technologies on Railroad Capacity. Performance, M.S. Thesis, University of Illinois at Urbana-Champaign, Urbana, IL.
- Dirnberger, J. R. (2006). Development and Application of Lean Railroading to Improve Classification Terminal Performance, M.S. Thesis, University of Illinois at Urbana-Champaign, Urbana, IL.
- Dirnberger, J.R. and C.P.L. Barkan (2007). Lean railroading: Improving railroad classification terminal performance through bottleneck management methods. *Transportation Research Record - Journal of the Transportation Research Board*, 1995, pp. 52-61.
- Droege, J. A. (1925). *Freight Terminals and Trains*, Second Edition, McGraw-Hill Book Company, New York.
- Edwards, J. R. (2006). Improving the Efficiency and Effectiveness of Railcar Safety Appliance Inspections Using Machine Vision Technology, M.S. Thesis, University of Illinois at Urbana-Champaign, Urbana, IL, 2006.
- Edwards, J. R., J. M. Hart, S. Todorovic, C. P. L. Barkan, N. Ahuja, Z. Chua, N. Kocher, and J. Zeman (2007). Development of Machine Vision Technology for Railcar Safety Appliance Inspection. *In Proceedings of the 9th International Heavy Haul Conference Specialist Technical Session - High Tech in Heavy Haul*, Kiruna, Sweden, 2007, pp. 745-752.
- Freid, B., C. P. L. Barkan, N. Ahuja, J. M. Hart, S. Todorovic, and N. Kocher (2007). Multispectral Machine Vision for Improved Undercarriage Inspection of Railroad Rolling Stock. *In Proc. of the 9th International Heavy Haul Conference Specialist Technical Session - High Tech in Heavy Haul*, Kiruna, Sweden, 11-13 June 2007, IHHA Inc., pp. 737-744.
- Gallagher, C. A. and W. M. Pelino (1959). Hot-box detector, U.S. Patent 2880309.
- Gallamore, R.E. (1999), Regulation and Innovation: Lessons from the American railroad industry. In: J.A. Gomez-Ibanez, W.B. Tye, & C. Winston, Eds. *Essays in Transportation Policy & Economics*. Brookings Institution Press, Washington, D.C., pp. 493-529.
- Garber N. J., and L. A. Hoel (2009). *Traffic and Highway Engineering*. 4th ed. Cengage Learning, Toronto, ON.
- Gibson S, G. Cooper, and B. Ball (2002). Developments in transport policy: The evolution of capacity charges on the UK rail network. *Journal of Transport Economics and Policy*, vol. 36, pp. 341–354.

- Glickman, T. S., and M. Gough (Eds.) (1990). *Readings in Risk*. Washington D.C., Resources for the Future.
- Harrod, S. (2009). Capacity Factors of a Mixed Speed Railway Network. *Transportation Research Part E*. vol. 45, no. 5, pp. 830-841.
- Hart, J. M., N. Ahuja, N., C. P. L. Barkan, and D. D. Davis (2004). A Machine Vision System for Monitoring Railcar Health: Preliminary Results. *Technology Digest: TD-04-008*. Association of American Railroads, Pueblo, Colorado, 2004.
- Hart, J. M., E. Resendiz, B. Freid, S. Sawadisavi, C. P. L. Barkan, and N. Ahuja (2008). Machine Vision Using Multi-Spectral Imaging for Undercarriage Inspection of Railroad Equipment. *In Proceedings of 8th World Congress on Railway Research*, Seoul, Korea, 2008.
- Hawthorne, K., R. B. Wiley, and T. Guins (2005). Wayside monitoring with ATSI aids wagon maintenance, *Railway Gazette*, 2005, vol. 161, no. 6, 337-340.
- Hopp, W. J. and M. L. Spearman (2004). To Pull or Not To Pull, What is the Question? *Manufacturing & Service Operations Management* vol. 6, no. 2, pp. 133–148, © 2004 INFORMS, www.factoryphysics.com, [7 May 2010].
- Hou, T.-H., L. Li, and C. G. Drury (1993). An empirical study of hybrid inspection systems and allocation of functions. *International Journal of Human Factors in Manufacturing*, vol. 3, pp. 351-367.
- Interstate Commerce Commission (ICC) (1889). *Proceedings of A General Conference of Railroad Commissioners*. Washington, D. C., 5-7 March 1889, pp. 108-110.
- Interstate Commerce Commission (ICC) (1893). *Seventh Annual Report of the Interstate Commerce Commission*, GPO, Washington D.C, 1893, pp 1-285.
- Interstate Commerce Commission (ICC) (1909). *Twenty-Third Annual Report of the Interstate Commerce Commission*, GPO, Washington D.C, 1909, pp 1-338.
- Kratville, W. W. ed. (1997). *The Car and Locomotive Cyclopedia of American Practices*. 6th ed, Simmons-Boardman Books, Inc. Omaha, NE.
- Kwon, O. K, C. D. Martland, J. M. Sussman, and P. Little (1995). Origin-to-Destination Trip Times and Reliability of Rail Freight Services in North American Railroads. *Transport. Res. Rec.*, 1995, 1489, pp. 1-8.
- Lai, Y.-C., C. P. L. Barkan, J. Drapa, N. Ahuja, J. M. Hart, P. J. Narayanan, C. V. Jawahar, A. Kumar, L. Milhon, and M. P. Stehly (2007). Machine vision analysis of the energy efficiency of intermodal freight trains. *Proc. Instn. Mech. Engrs., Part F: J. Rail and Rapid Transit*, vol. 221, pp. 353-364.

- Lagnebäck, R. (2007). Evaluation of wayside condition monitoring technologies for condition-based maintenance of railway vehicles, Licentiate Thesis, Luleå University of Technology, Luleå, Sweden, 2007.
- Logan, P. (2006). Role of Yard or Terminal in Operating Performance and Capacity. Presentation at 85th Annual Meeting of the Transportation Research Board, Washington, D.C.
- Lundgren, J. and C. Killian (2005). Advanced rail vehicle inspections system. *In Proceedings of 8th International Heavy Haul Conference*, Rio De Janeiro, Brazil, 14-16 June 2005, IHHA Inc., pp. 807-814.
- McGuire, B., R. Sarunac, and R. B. Wiley (2007). Wayside Wheel/Rail Load Detector Based Rail Car Preventive Maintenance. *Proceedings of 2007 ASME/IEEE Joint Rail Conference & Internal Combustion Engine Spring Technical Conference*, Pueblo, CO, 13-16 March 2007, pp. 19-28.
- Martland, C. D., P. Little, O. K. Kwon, and R. Dontula (1992). Background on Railroad Reliability. *AAR Report No. R-803*. Association of American Railroads, Washington, DC, 1992.
- Mattsson, L.-G. (2007). *Railway Capacity and Train Delay Relationships*. Springer, Berlin Heidelberg, pp. 129-150.
- Morgan, R. (2002). TTCI evaluates wheel profile condition measurement systems: machine-vision-based wheel profile measurement systems can fill a gap in revenue-service equipment condition monitoring - TTCI R & D - Transportation Technology Center, Inc. *Railway Track and Structures*, July 2002.
- Morgan, R. and A. Gerald (2003). TTCI plays detective - Transportation Technology Center Inc.'s Integrated Railway Remote Information Service. *Railway Age*, February 2003, Simmons-Boardman Publishing Corporation, http://findarticles.com/p/articles/mi_m1215/is_2_204/, [1 December 2009].
- Murray, T. (2002). Wrong train running. *Trains*, July 2002, pp. 30-35.
- National Association of Railway Commissioners (NARC) (1909). *Proceedings of the Twenty-First Annual Convention*. Washington D.C., 16-19 November, 1909.
- National Railway History Society, Inc. (NRHS) (2006). Railroad Historical Almanac 1900-1919, <http://www.nrhs.com/almanac/index.html>, [June 2010].
- Office of Technology Assessment (OTA), Congress of the United States (1978). *An Evaluation of Railroad Safety*. US Government Printing Office, Washington, D.C., May, 1978.

- Ohno, T. (1988). *Toyota Production System: Beyond Large Scale Production*. Productivity Press, Cambridge, MA.
- Ouyang, Y., X. Li, Y.-C. Lai, C. P. L. Barkan, and A. Kawprasert (2009). Optimal Locations of Railroad Wayside Defect Detection Installations. *Comput.-Aided Civ. Inf.*, 2009, vol. 24, pp. 1-11.
- Parsons Brinckerhoff Quade & Douglas (PBQ&D), Inc. (2002). The Long Term Financial Feasibility of the Northwestern Pacific Railroad, Draft Final. <http://www.northcoastrailroad.org/feasibility.html>, [March 15, 2009].
- Post, W. M. (1936). Protective system for railways, U.S. Patent 2063336.
- Post, W. M. (1937). Protective system for railways, U.S. Patent 2095616.
- Railway Age (2009). Turning “finders” into “fixers”: Data for data’s sake, or for a useful purpose? *Railway Age*. November 2009. pp. 29-31.
- Railway Educational Bureau (REB) (1996). Guidelines for Trainyard Inspection of Freight Cars, The Railway Educational Bureau, Omaha, NE.
- Railroad Gazette (1884). “The Car Inspector.” *Railroad Gazette: A Journal of Transportation, Engineering and Railroad News*, vol. 16, 28th yr., 18 April 1884, New York, pp. 306.
- Railroad Gazette (1903). “Inspecting Cars.” *Railroad Gazette: A Journal of Transportation, Engineering and Railroad News*, vol. 35, 48th yr., 30 October 1903, New York, pp. 784.
- Railway Systems and Management Association (RSMA) (1967). *Railroad Terminal Strategy*. Railway Systems and Management Association, Chicago, IL, June, 1967, pp. 1-96.
- Robeda, J. and S. Kalay (2008). Technology drives US train inspections. *International Railway Journal*, vol. 48, no. 5, pp. 47-50.
- Robert, W., A. Aeppli, and P. Little (2009). Post-Audit of Wayside Detector Costs and Benefits. Cambridge Systematics Inc., 10 September 2009.
- Savage, Ian (1998). *The Economics of Railroad Safety*. Kluwer Academic Publishers, Norwell, MA, pp. 25-26.
- Schafer, D. H. (2006). Effect of Train Length on Railroad Accidents and a Quantitative Analysis of Factors Affecting Broken Rails, M.S. Thesis, University of Illinois at Urbana-Champaign, Urbana, IL.
- Schafer, D. H. and C.P.L. Barkan (2008). A Prediction Model For Broken Rails and an Analysis of their Economic Impact, *Proceedings of the 2008 AREMA Conference*, Salt Lake City, UT.

- Schlake, B. W., C. P. L. Barkan, and J. R. Edwards (2010). Impact of Automated Inspection Technology on Unit Train Performance, in Proceedings of *Joint Rail Conference 2010*, Urbana, IL, 27-29 April 2010.
- Schlake, B. W., C. P. L. Barkan, and J. R. Edwards (2010b). Impact of Automated Condition Monitoring Technologies on Railroad Terminal Performance, in Proceedings of *AREMA Annual Conference 2010*, Orlando, FL, 29 August to 1 September, 2010.
- Schlake, B. W., C. P. L. Barkan, and J. R. Edwards (2010c). Train Delay and Economic Impact of Railroad Rolling Stock In-Service Failures, submitted to *Transportation Research Record: Journal of the Transportation Research Board*, Transportation Research Board of the National Academies, Washington, D.C.
- Schlake, B. W., S. Todorovic, J. R. Edwards, J. M. Hart, N. Ahuja, and C. P. L. Barkan (2010d). Machine Vision Condition Monitoring of Heavy-Axle Load Railcar Structural Underframe Components. (In Press) Proceedings of the Institution of Mechanical Engineers, Part F: Journal of Rail and Rapid Transit.
- Steets, P. G, and Tse, Y. H. (1998). Conrail's integrated automated wayside inspection, *In Proceedings of the IEEE/ASME Joint Railroad Conference 1998*, IEEE, Piscataway, NJ, pp. 113–25.
- Tabb, M. and N. Ahuja (1997). Multiscale image segmentation by integrated edge and region detection. *IEEE Trans. Image Process.*, 1997, vol. 6, no. 5, pp. 642–655.
- Tournay, H. M. and S. Cummings (2005). Monitoring the Performance of Railroad Cars by means of Wayside Detectors in Support of Predictive Maintenance. In *Proceedings of 8th International Heavy Haul Conference*, Rio De Janeiro, Brazil, 14-16 June 2005, IHHA Inc., pp. 501-510.
- Tournay, H. and T. Stahura (2010). Detector Technology Implementation and Advanced Technology Safety Initiative. Presentation at 15th Annual AAR Research Review, Pueblo, CO, 2-3 March 2010.
- United States Census Office (1902). Cars, Steam Railroad, By G.A. Hutchins, Manufactures Report, Twelfth Census of the United States, 1900, Part IV, Washington D.C., pp. 263-289.
- United States Department of Transportation (US DOT) (2008). Federal Railroad Administration (FRA) Office of Safety. Code of Federal Regulations Title 49, Railroad Freight Car Safety Standards – Parts 215. March 1, 2008 (Simmons-Boardman Books, Inc., The Railway Educational Bureau, Omaha, NE).
- United States Department of Transportation (US DOT) (2008b). Federal Railroad Administration (FRA). Motive Power and Equipment Compliance Manual. Chapter 4, pp. 22, <http://www.fra.dot.gov/us/content/1248>, [25 July 2008].

- United States Department of Transportation (US DOT) (2009). Federal Railroad Administration (FRA) Office of Safety. Federal Railroad Administration Office of Safety Analysis, Washington, D.C., sec. 3.01-3.04, 9.01 and 9.05, <http://safetydata.fra.dot.gov/officeofsafety/>, [14 December 2009].
- United States Department of Transportation (US DOT) (2010). Federal Railroad Administration (FRA) Office of Safety. Code of Federal Regulations Title 49, Railroad Freight Car Safety Standards – Parts 215 and 232. 17 February 2010, (Simmons-Boardman Books, Inc., The Railway Educational Bureau, Omaha, NE).
- Washington Group International (WGI), Inc. (2007). RTC Simulations – LOSSAN North Railroad Capacity and Performance Analysis. LOSSAN Rail Corridor Agency and IBI Group, www.sbcag.org/Meetings/SCSPC/2007/February/Item5LOSSANSR.pdf, [15, March 2009].
- Wellington, A. (1887). *The Economic Theory of Railway Location*, Sixth Edition. John Wiley & Sons, New York. pp. 485-491.
- White, J. H. Jr. (1993). *The American Railroad Freight Car*. Johns Hopkins University Press, Baltimore, pp. 64, 65, and 107.
- Womack, J. P., D. T. Jones, and D. Roos (1990). *The Machine That Changed the World: The Story of Lean Production*. HarperCollins Publishers, New York.
- Womack, J. P., and D. T. Jones (2003). *Lean Thinking: Banish Waste and Create Wealth in Your Corporation*. Free Press, New York.
- Wright, Roy V. ed. (1922). “Apprentices-Inspectors,” *Car Builders’ Cyclopedia of American Practice*, 10th ed. Simmons-Boardman, New York, pp. 1162- 1163.