

LABORATORY STUDY TO DETERMINE
THE EFFECTS OF TIE PAD STIFFNESS ON THE
ATTENUATION OF IMPACT LOADS IN
CONCRETE RAILROAD TIES

by

Francis E. Dean and Harold D. Harrison

January, 1982

BATTELLE
Columbus Laboratories
505 King Avenue
Columbus, Ohio 43201

NOTICE

The United States Government does not endorse products or manufacturers. Trade or manufacturers' names appear herein solely because they are considered essential to the object of this report.

NOTICE

This document is disseminated under the sponsorship of the Department of Transportation in the interest of information exchange. The United States Government assumes no liability for its contents or use thereof.

1. Report No. <i>FRA/ORD-82/19</i>	2. Government Accession No.	3. Recipient's Catalog No.	
4. Title and Subtitle Laboratory Study to Determine the Effects of Tie Pad Stiffness on Attenuation of Strain in Concrete Ties		5. Report Date January 1982 (MAY 82)	6. Performing Organization Code
7. Author(s) FE Dean & HD Harrison		8. Performing Organization Report No.	
9. Performing Organization Name and Address Battelle Columbus Laboratories 505 King Avenue Columbus, Ohio 43201		10. Work Unit No. (TRAVIS)	11. Contract or Grant No. DOT-FR-9162
12. Sponsoring Agency Name and Address US Department of Transportation Federal Railroad Administration Office of Research & Development Washington, DC 20590		13. Type of Report and Period Covered Interim Report April - June 1981	
15. Supplementary Notes		14. Sponsoring Agency Code RRD 32	
16. Abstract <p>The effect of tie pad stiffness on the bending moments produced by impact loading of concrete railroad ties was investigated in laboratory tests. Controlled impact loads were applied to a one-tie test arrangement in which the pads were interchanged. Beginning with a rigid plastic pad currently in use on the Northeast Corridor track, the test loads reproduced the time history of bending strain which had been previously measured in track. It was also found that the initiation of bending cracks and their subsequent propagation closely matched crack development observed in track.</p> <p>Using the rigid plastic pad as a reference, the ability of a variety of tie pads to attenuate impact response was measured at load levels below the cracking limit. The stiffness of each pad was measured statically and at load rates of 9 - 10 Hz. It was found that major reductions in pad stiffness can significantly reduce the effect of impact loading, but that the stiffness measurements of flexible pads do not provide a reliable measure of impact attenuation properties.</p>			
17. Key Words Concrete ties Impact Loads Tie pads Pad Stiffness Strain attenuation		18. Distribution Statement Document is available to the public through the National Technical Information Service, Springfield, Virginia 22161	
19. Security Classif. (of this report) Unclassified	20. Security Classif. (of this page) Unclassified	21. No. of Pages	22. Price

METRIC EQUIVALENTS OF ENGLISH UNITS USED IN THIS REPORT

Multiply the English Unit by To obtain the Metric Unit

Basic Units:

Foot	(ft)	0.3048	Meter	(m)
Inch	(in)	25.4	Millimeter	(mm)
Pound (force)	(lb)	4.4482	Newton	(N)
Degrees Fahrenheit	(°F)	$5/9 (F - 32)$	Degrees Celcius	(C)

Combined Units

Kip = 1000 lb	(kip)	0.3048	Kilonewton	(kN)
Foot-Pound	(ft-lb)	1.3358	Joule = Watt-Sec.	(J)
Pound/Inch	(lb/in)	1.751	Newton/millimeter	(N/mm)
Strain	(μ in/in)	1	Strain	(μ m/m)

TABLE OF CONTENTS

	<u>Page No.</u>
PREFACE.	iii
EXECUTIVE SUMMARY.	iv
INTRODUCTION	1
SUMMARY OF RESULTS	2
TEST PROCEDURES.	4
Impact Loading Fixture	4
Instrumentation.	4
Strain Measurement.	4
Strain Calibration.	7
Crack Identification	7
TEST RESULTS	10
Spectral Analysis.	10
Variation of Impact Parameters	10
Effect of Pad Stiffness on Strain Attenuation.	12
Selection of Pads for NEC Field Tests	12
Additional Impact Attenuation Tests	17
Tests Under Worst-Case Impacts.	19
Destructive Tie Tests.	22
CONCLUSIONS.	24
REFERENCES	26

LIST OF FIGURES

	<u>Page No.</u>
FIGURE 1. Schematic of Impact Test Arrangement.	5
FIGURE 2. Impact Loading Fixture.	6
FIGURE 3. Loading Arrangement for Calibration	8
FIGURE 4. Instrumentation for Measurement of Impact Strain.	9
FIGURE 5. Frequency Spectra of Rail Seat Bending Strain From Track and Laboratory Measurements.	11
FIGURE 6. Typical Time Histories of Tie Strain From Track and Laboratory Measurements	13
FIGURE 7. Effect of Tie Pad Substitutions on Impact Strain at Tie Rail Seat	14
FIGURE 8. Typical Load-Deflection Plots From Tie Pad Stiffness Measurements.	15
FIGURE 9. Tie Bending Moment vs. Drop Height for Tests Up to Maximum Simulated Track Input	20
FIGURE 10. Tie Crack Development vs. Impact Hammer Drop Height . . .	23

LIST OF TABLES

TABLE 1. Tie Pad Stiffness and Impact Attenuation Rates from Basic Tests	16
TABLE 2. Tie Pad Stiffness and Impact Attenuation Rates from Additional Tests.	18

PREFACE

This investigation was conducted at Battelle's Columbus Laboratories to determine the effects of tie pad stiffness on the attenuation of dynamic loads in prestressed concrete railroad ties. The work represents one phase of a program sponsored by the Federal Railroad Administration (FRA) with the assistance of the National Railroad Passenger Corporation (Amtrak). The program is being carried out under Contract DOT-FR-9162, "Tie and Fastener Verification Studies".

The overall objective of the program is to define a practical method for reduction of impact-produced tie strain to levels which will prevent further crack development. Other phases of the program include: (1) an analysis of dynamic loads and tie strain data previously collected on the Northeast Corridor track, and (2) track measurements using pads of different stiffness, to verify the results of the laboratory study described in this report.

Mr. Howard Moody of the FRA Improved Track Structures Research Division was the Contracting Officer's Technical Representative for this program. Other sponsoring participants were Mr. Ted Ferragut of the FRA Office of Intercity Programs, Mr. Dennis Wilcox of Amtrak, and Mr. Dan Jerman of Amtrak. The contributions of these people to the successful completion of this project are greatly appreciated.

EXECUTIVE SUMMARY

The effect of tie pad stiffness on the attenuation of impact loads in concrete railroad ties was investigated with a one-tie laboratory test arrangement. This study was one part of a program conducted to identify the cause and to recommend a solution for the development of rail seat bending cracks in concrete ties on the Northeast Corridor track. These hairline cracks have been found in ties with service histories ranging from a few months to about two years. While the cracks do not constitute structural failure, they have caused concern because: (1) the ties were designed to sustain all anticipated loads without cracking, and (2) the cracks are of the same type which has eventually resulted in failure of earlier tie designs.

The major objectives of the laboratory tests were: (1) to identify a value of tie pad stiffness which would prevent the initiation of cracks in ties subjected to the highest levels of impact energy found in service and (2) to select pads for subsequent verification of the laboratory results in field tests. The thickness of the pads to be used in field tests was limited to 6.5 mm to permit retention of current fastener clips.

A fixture was constructed to deliver controlled impact loads to a short rail segment which was fastened to one rail seat of the test tie. Tie bending strain was calibrated to measure rail seat bending moment in a manner identical to that previously used in track. The time history of field-measured impact bending moment was closely matched by the impact loading fixture.

Nondestructive instrumented tests were conducted with the rigid plastic pad currently used on the Northeast Corridor track and with a variety of more flexible pads of thicknesses between 5 and 9 mm. Within the practical range of pad thickness, a maximum impact bending moment attenuation of 25 percent was found relative to that produced by the current pad. The overall maximum impact attenuation was obtained with a heavily grooved pad of 9 mm thickness. This pad, with one-tenth the stiffness of the current pad, provided a 40 percent attenuation of impact bending moment.

Pad stiffness was measured as the slope of the line connecting points at 4,000 and 20,000 pounds on the compressive side of a load-deflection curve recorded at the loading rate of 9 - 10 cycles per second. While impact attenuation generally increased with decrease in stiffness, the stiffness did not provide a reliable indicator of impact attenuation.

Destructive impact tests were conducted on two Northeast Corridor ties and on a smaller tie made of latex-modified concrete. The current rigid plastic pad was used in all of these tests. Cracks initially appeared on the conventional ties at a drop height of 16 inches, vs. 18 inches for the latex-modified tie. With increased drop heights, the cracks continued to propagate upward and to develop a pattern often found in service: a "Y" which starts at the top prestress strand and propagates toward the gage and field side fastener shoulders.

The subsequent field tests [3] verified that a flexible pad which is compatible with the current fastener clip could significantly reduce the frequency of occurrence of impact loads with the potential to crack a tie. However, some exceedances of the cracking threshold occurred with the most flexible pad tested in service. Therefore, the elimination of further crack development will require both a more flexible pad and a program to remove the worst wheel tread conditions on high-speed passenger traffic.

LABORATORY STUDY TO DETERMINE THE EFFECTS
OF TIE PAD STIFFNESS ON THE ATTENUATION
OF IMPACT LOADS IN CONCRETE RAILROAD TIES

INTRODUCTION

This investigation was conducted by Battelle's Columbus Laboratories to determine the effect of tie pad stiffness on the attenuation of impact loads in prestressed concrete railroad ties. The need for this study arose in June, 1980 when hairline rail seat cracks were found on ties initially put in service in December, 1978 on the Northeast Corridor (NEC) track at Aberdeen, Maryland. Other inspections found cracks on ties in service only a few months. While the cracks do not presently impair the function of the ties, continued crack growth could result in loss of bending strength to an extent which could require tie replacements after a life cycle much shorter than the projected 50 years.

As part of another FRA project in June 1980, Battelle conducted measurements of wheel/rail loads and tie strains on the NEC track at Aberdeen. An analysis of these measurements [1] showed that the most severe dynamic loads are produced by wheel irregularities on passenger coaches travelling at speeds above 70 mph. Wheel/rail loads up to 5 times the static wheel load were measured. Tie strains above the level which can initiate cracks were caused by about 0.1 percent of the passenger train wheels. This frequency of occurrence of high-impact loading has been sufficient to initiate cracks in most ties with more than one year of service [2].

One possible solution to reduce the extent of cracking consists of replacing the current tie pad with a more flexible pad which offers greater attenuation of impact loads. This offers the potential of reducing the impact loading from anomalies in the rail running surface (engine burns, welds and joints) as well as from the irregularities of train wheels. To assess the effect of pad substitution in the laboratory, a method was required by which impact loads could be reproduced in a controlled manner. For this purpose, Battelle designed and constructed an impact loading fixture and conducted the tests described in the following sections.

The major objective of the laboratory tests were: (1) to identify a level of tie pad stiffness which would prevent the initiation of tie cracks when the ties were subjected to the highest levels of impact energy measured in track and (2) to select pads to be used in a field test program. The first objective was accomplished within the limitations of the "single-tie" laboratory setup. The effects of the tie pad substitutions were then verified by measurements in track [3].

SUMMARY OF RESULTS

The major results of this investigation were:

- a. Tie bending moments produced by impact loads measured in track were successfully reproduced in the laboratory by single blows of the impact fixture drop hammer. By varying drop heights of the 115-lb hammer, the range of track-measured bending moment amplitudes was spanned. The rise time and shape of the impact pulse was closely duplicated by trial-and-error adjustment of a resilient shim between the hammer head and hammer. The dynamic response of the tie was shown to be essentially independent of the tie support conditions.
- b. The strain measurement system used in track and in the laboratory was calibrated to indicate bending moment in the elastic (pre-crack) range. This same calibration or sensitivity was maintained after cracking to indicate relative magnitudes of strain. In tests with the pad currently installed in track, the first crack initiation occurred consistently at a drop height of 16 inches for two types of current-design prestressed concrete ties.* Tie strain at the previous drop height (14 inches) was equivalent to 350 inch-kips of statically applied bending moment. This is approximately 10 percent less than the mean bending moment at which crack initiation occurs in static bending moment tests. These results indicate that there is very little difference between the static and dynamic bending strength of the ties.
- c. With increased drop heights, the rail seat bending cracks continued to propagate upward from the tie bottom and developed a pattern often found in service: a "Y" which initiates at the top of the prestress strands. The maximum drop height was 36 inches, at which point the cracks extended to heights between 4 and 5 inches, measured perpendicularly from the bottom surface of the tie. This represents the approximate condition of the most advanced cracks seen in track.
- d. Nondestructive instrumented drop tests were conducted with the EVA pad which is currently used on the Northeast Corridor and with eight pads of lower stiffness. These tests demonstrated a decrease in bending moment levels with decrease in pad stiffness for most pads. The following table illustrates the approximate degree of bending moment attenuation obtained with reduction in pad stiffness:

*Santa-Fe/San Val RT7SS-2 (used on the NEC) and Conforce Costain CC244C.

PAD TYPE	NOMINAL DYNAMIC STIFFNESS (LB/IN) FOR LOADS BETWEEN 4,000 AND 20,000 POUNDS	PERCENT PEAK BENDING MOMENT ATTENUATION
EVA	5,000,000	0
DAYCO 7454, X4 JAMES WALKER 584 TOKAI TYPE B	1,300,000 - 2,400,000	11 - 15
STEDDEF 5 mm SYNTHETIC RUBBER	1,180,000	18
DANISH TRELLEBORG	950,000	19
STEDDEF 6.5 mm SYNTHETIC RUBBER	850,000	25
STEDDEF 9 mm SYNTHETIC RUBBER	500,000	40

- e. Instrumented tests were extended to simulate the worst conditions measured in track. With the EVA pad, a drop height of 20 inches produced bending moment levels greater than the maximum track-measured value of 600 inch-kips. A test to this height with the 6.5-mm synthetic rubber pad produced bending moments which indicated a borderline cracking condition. With the 9-mm synthetic rubber pad, this same borderline cracking level required 28 inches of drop height, which simulated an impact condition substantially worse than any measured in track during the June 1980 tests.
- f. A noninstrumented test of a Stresscoated tie was conducted with the 9-mm pad to a drop height of 36 inches. No rail seat bending cracks were found. However, the thickness of 9 mm is not a practical alternative for the NEC track at this time.
- g. A noninstrumented destructive test was also conducted on one BW-3 latex modified concrete tie. After drops to a maximum height of 36 inches with an EVA rail pad, this tie developed a rail seat bending crack which extended slightly under 4 inches up the tie face from the bottom tie surface (vs. 4 to 5 inches for the conventional ties). The first crack developed at a drop height of 18 inches vs. 16 inches with the conventional ties. Additional tests would be required to determine if this improvement in crack restraint is statistically significant.
- h. Examination of both rail seats on ties in the noninstrumented destructive tests revealed that both rail seats can crack when impacts are applied to only one rail seat. This is due to the lightly damped propagation of impact strain through the tie, which vibrates with a combination of its three lowest bending frequencies. The cracks were less severe on the nonimpacted end. The cracking was not sensitive to the application of static clamping load to the nonimpacted end. This phenomenon was less apparent on the latex modified tie.

TEST PROCEDURES

Impact Loading Fixture

A schematic of the dynamic loading arrangement is illustrated in Figure 1. To obtain the greatest possible range of impact amplitude and frequency content, provision was made for:

- a. Static loading in parallel with the impact loading
- b. Variation of impact hammer impedance by substitution of a shim between the hammer head and hammer, and if required, variation of the shape of the hammer head
- c. Variation of the support condition under the tie, by changing the spacing of Neoprene support strips
- d. A hammer weight range of 0 to 400 pounds
- e. Drop heights from 0 to 56 inches.

The physical arrangement of the drop fixture is shown in the photo of Figure 2. The two vertical tubes provide static load, guide the drop hammer and permit the positioning of a frame which seats the drop hammer at any selected height. An electric hoist is suspended at the top of the frame and spring-mounted to prevent overload of the hoist chain as the hammer is seated. A quick-release mechanism releases the drop hammer from its seat in the frame.

Instrumentation

Strain Measurement

To be consistent with methods used earlier in field tests, tie strain was measured by strain gage coupons placed as shown in Figure 1. Each coupon consists of two active gages mounted longitudinally along the coupon axis and two "floater" gages, mounted transversely and mechanically isolated from the test specimen. The four gages form a complete resistance bridge. The floater gages provide temperature compensation, although the degree of compensation is less than that which would be available if the transverse gages were active (attached to the tie). Active transverse gages could not be used because transverse compressive stresses would add to the coupon response.

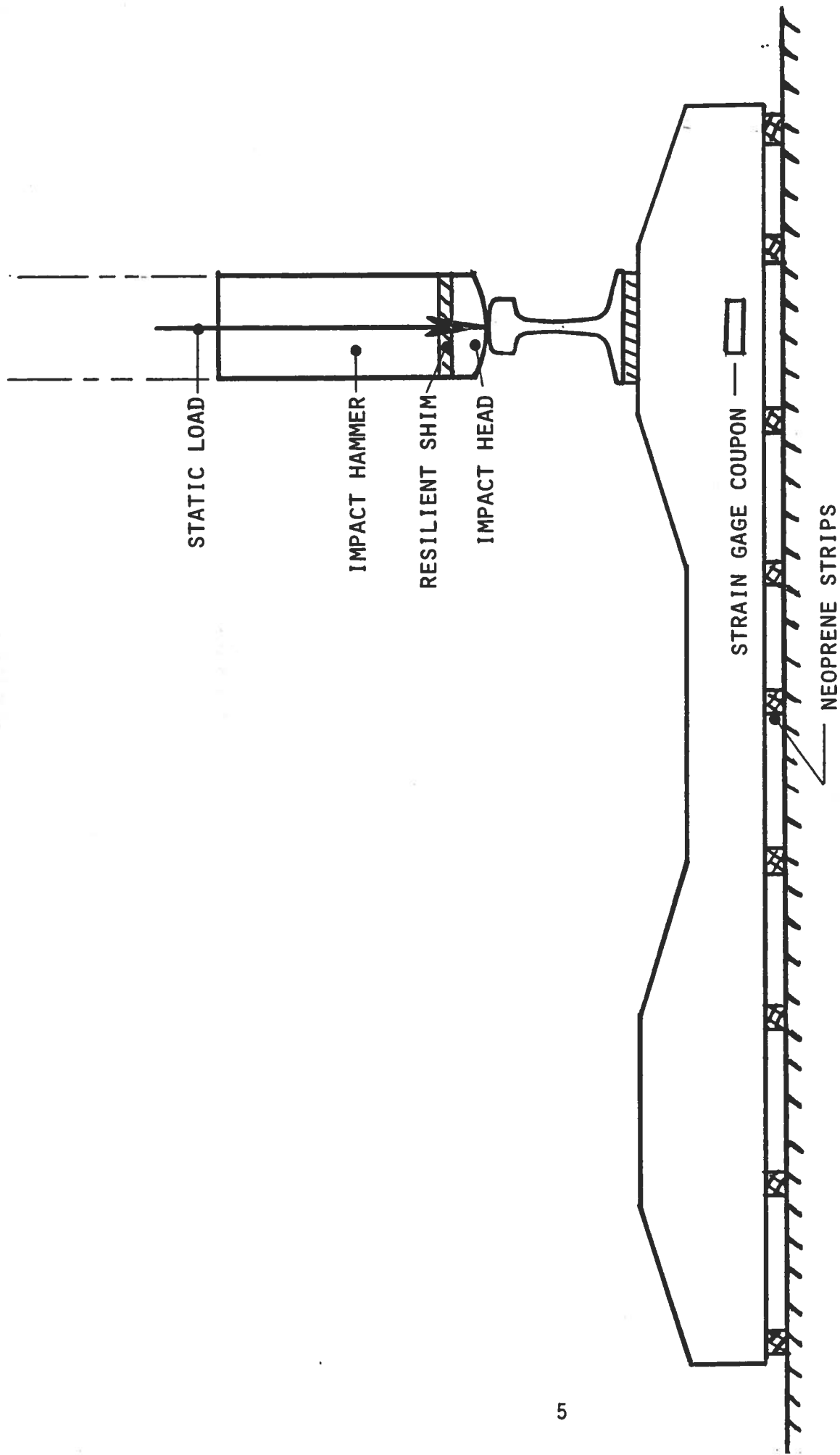

FIGURE 1. SCHEMATIC OF IMPACT TEST ARRANGEMENT

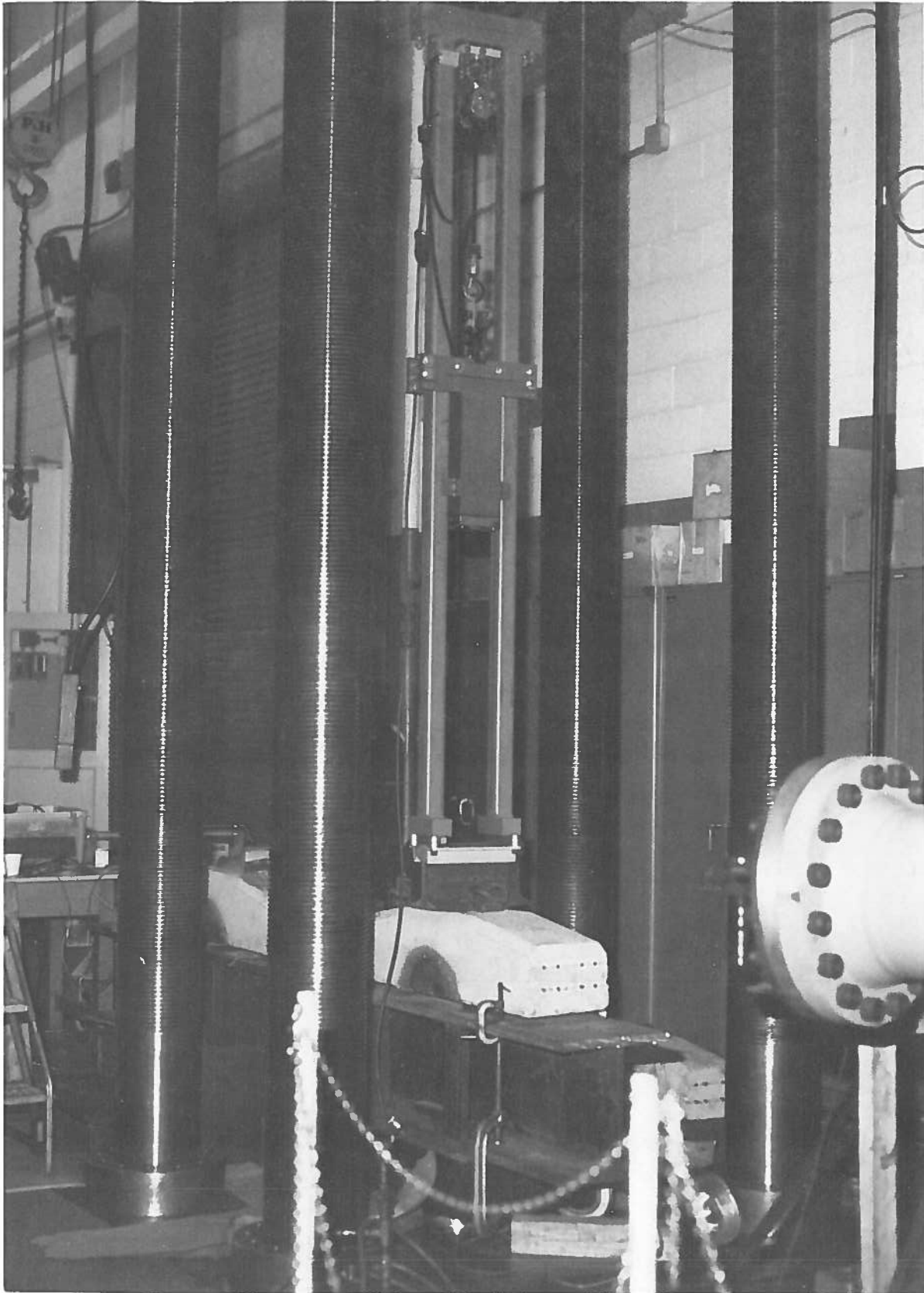

FIGURE 2. IMPACT LOADING FIXTURE

Strain Calibration

Strain calibration was performed on two ties by application of static bending moment to the rail seat area of the tie. The loading arrangement normally used in track was duplicated as shown in Figure 3. The pad load is assumed to be replaced by two discrete forces located by an effective moment arm. This moment arm was determined during an earlier calibration program in which loads applied through 2-inch rubber strips and through pads were compared.

The calibration permits the output voltage of the strain gage bridge to be expressed in terms of the static bending moment which produces this output voltage in the linearly elastic (non-crack) range. The same bridge sensitivity was maintained after cracking to show relative strain magnitudes. With first cracking, the slope of the strain - bending moment curve is maintained, but the amplitude may increase or decrease. With more advanced cracking, the original relationship is lost and permanent strain can be seen with each blow of the drop hammer.

Because the static calibrations were very consistent with the first 2 instrumented ties, the third tie was calibrated by adjusting the peak of the strain coupon output voltage to match that produced on the first two ties at 14-inch drop height (350 inch-kips). A later setup of the fixture in a new location produced higher strain response (375 inch-kips) with the same sensitivity. This was due in part to a change in the modulus of support (steel beam vs. concrete floor) and in part because the third gage displayed some drift during all of its tests.

The gain or sensitivity of the recording circuit was maintained by shunt calibrations. Originally, this calibration was performed with two 1-Megohm resistors placed in parallel across each of the two active gages. This was equivalent to one 500 K-ohm resistor across each of the 2 gages. A later arrangement used only a single-arm calibration with one 250 K-ohm resistor. This change produced no apparent error. A schematic of the strain gage bridge and the recording system used for calibration is shown in Figure 4.

Crack Identification

An opaque epoxy coating was applied to the first trial tie, a previously instrumented CC244C. After crack initiation had been identified from a sudden drop in bending moment amplitude, a hairline crack was discovered in the epoxy on the face opposite the gage. A crack could not be found on the gage side. This led to a search for a coating which would more quickly reveal crack initiation. The final result consisted of Stresscoat undercoat and resin designed for use at temperatures as low as 65 degrees. The temperature of the fatigue lab is held continuously at 70 degrees - a necessary condition for effective use of brittle coatings. On Stresscoated tie faces, crack initiation could be identified earlier than with the epoxy coating or on untreated faces. While this procedure is not consistent with the method used to identify cracks on ties in track, it was deemed important to find cracks at the lowest bending moment level at which they occurred.

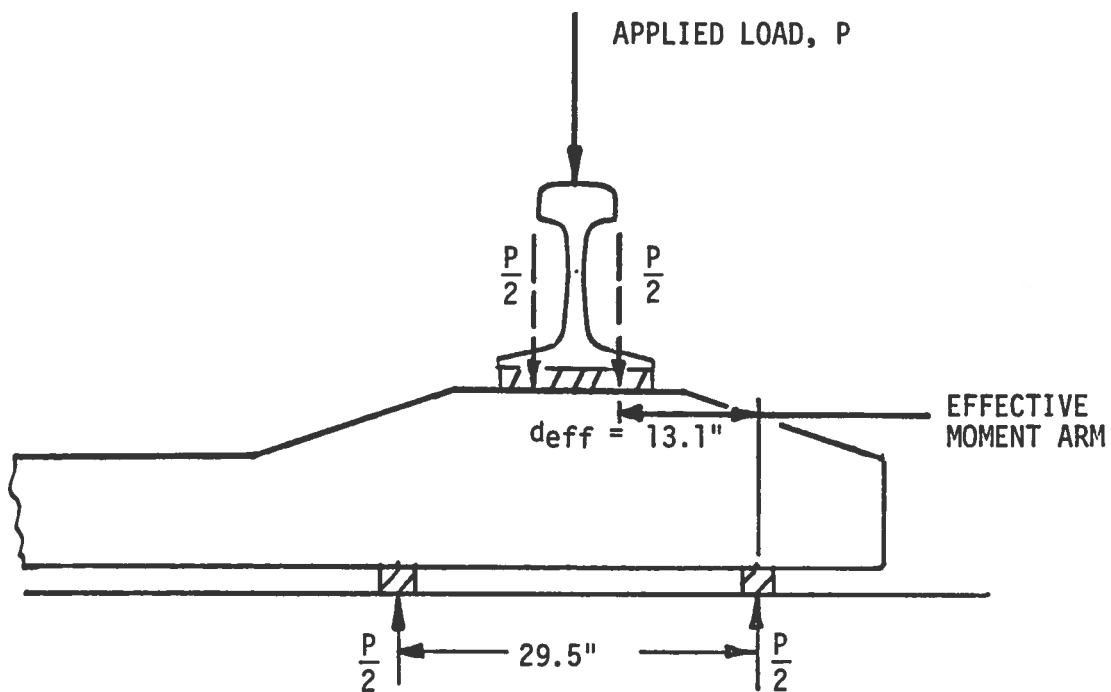

$$\text{APPLIED MOMENT } M = \frac{P d_{eff}}{2} = 6.55 P$$

FIGURE 3. LOADING ARRANGEMENT FOR CALIBRATION

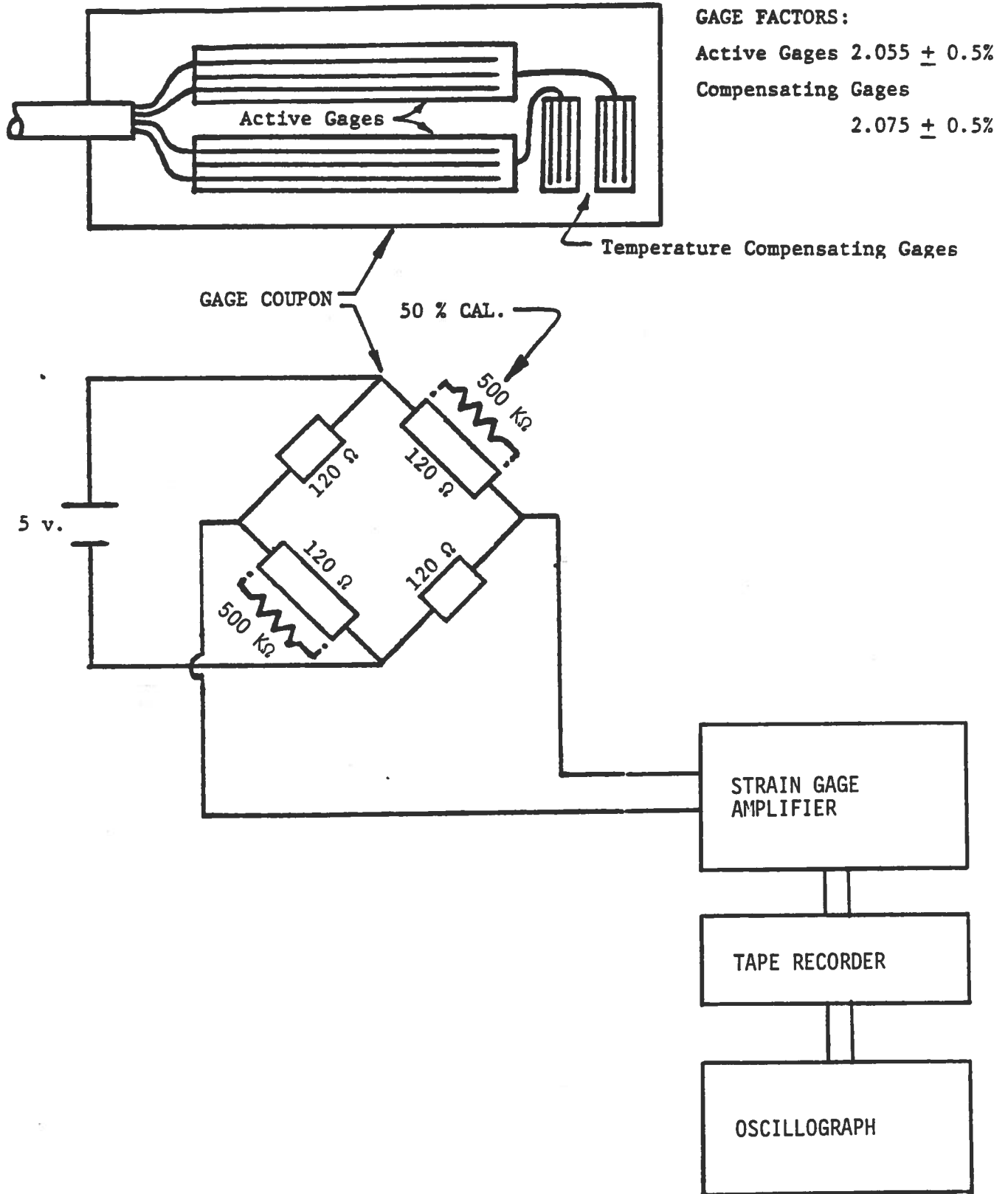

FIGURE 4. INSTRUMENTATION FOR MEASUREMENT OF IMPACT STRAIN

TEST RESULTS

Spectral Analysis

Spectral analysis of the tie dynamic response was performed early in the program by placing an accelerometer at each of 11 points of the tie surface and capturing the vibration produced by each of three blows with the drop hammer. These acceleration spectra were used to identify the relative magnitudes of acceleration occurring at the first three bending frequencies.

While contributions from the first three bending modes of the tie could be seen in the laboratory spectral analyses, the second bending mode was dominant. This contrasted with a much more even distribution of frequency content seen in the field data (Figure 5). However, the presence of the first three bending modes from both field and laboratory data indicated that the tie response was largely independent of the tie support conditions. This allowed the analysis to be conducted in the laboratory without an extensive effort to duplicate the tie support conditions experienced in track.

Variation of Impact Parameters

Trial-and-error variations of impact parameters were conducted to obtain laboratory simulation of impact strains and tie support conditions. Time histories of track-measured strains were characterized by initial impact pulses of about 1.5 millisecond time duration and peak amplitudes ranging up to 600 inch-kips. Spectral analyses showed significant excitation of the first three bending modes of the tie, at 131, 356 and 638 Hz. For the laboratory simulation, it was considered essential to span the range of measured strain amplitudes, to closely match the time duration of the first impact strain pulse, and to approximately match the first three bending frequencies of the tie.

A series of tests were conducted with the current Northeast Corridor pad (EVA) and a previously instrumented CC244C tie, which has approximately the same stiffness and weight distribution as the RT 7SS-2 tie. The impact parameters varied during this series included the drop height, hammer head shim stiffness, static load and the spacing of the tie support strips. These tests revealed that:

- a. Strain amplitudes near the static breaking strength of the tie were produced at a drop height of 14 inches with the 115-pound drop hammer. Since the drop height could be increased up to 56 inches, an adequate reserve of impact energy was available.
- b. The time duration of the first impact pulse could be most closely simulated with minimum static load and a flexible hammer head shim. A section of Duraflex pad was used as the final shim. For

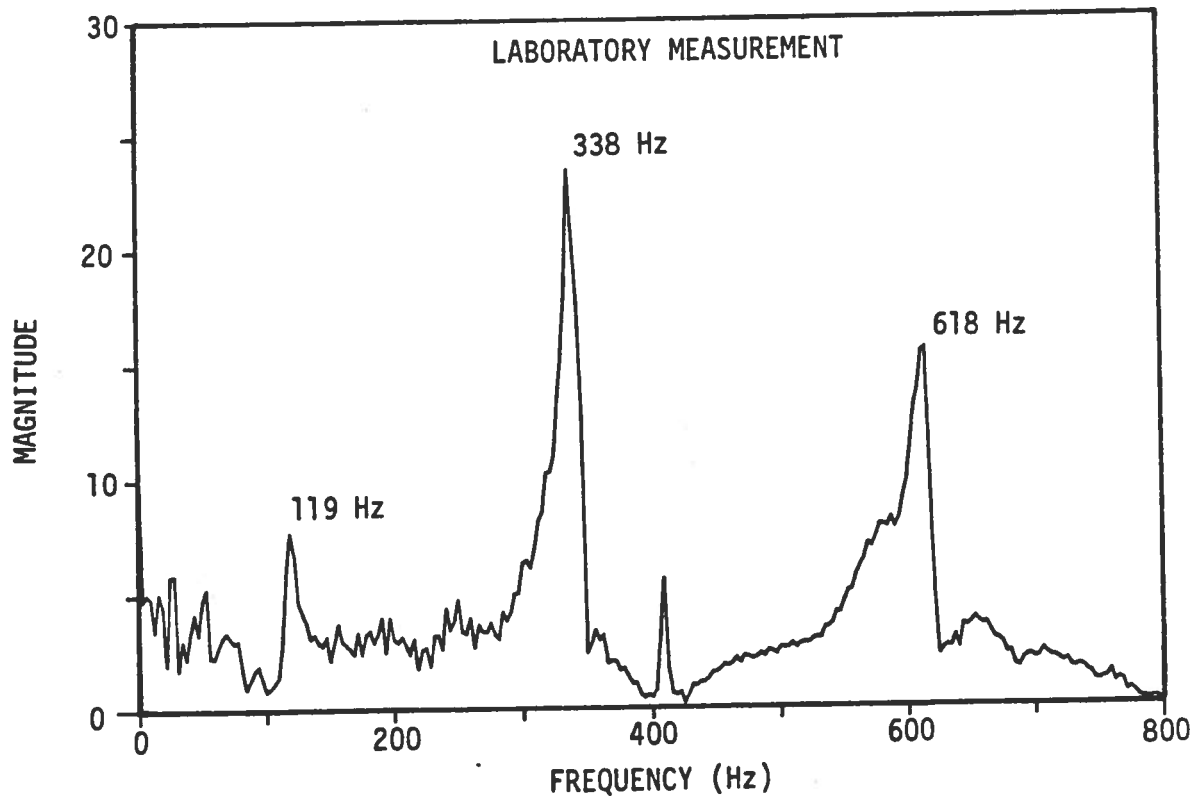
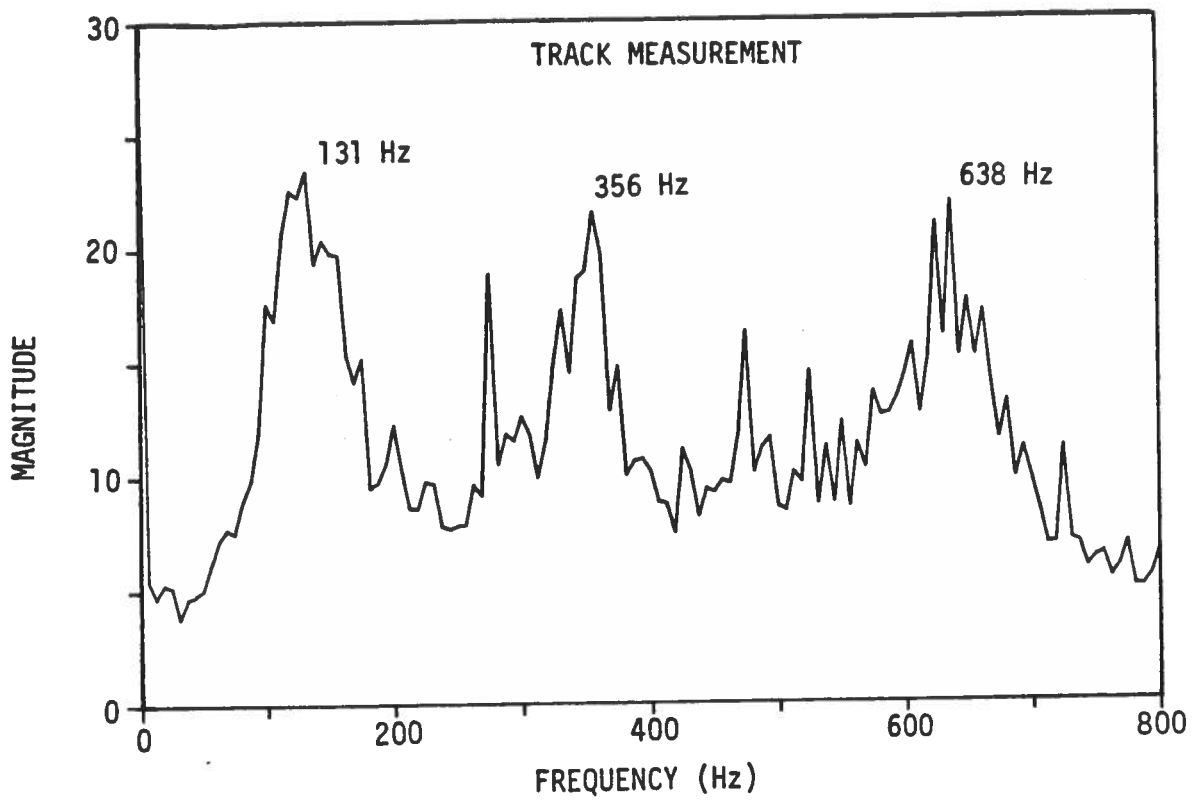

FIGURE 5. FREQUENCY SPECTRA OF RAIL SEAT BENDING STRAIN FROM TRACK AND LABORATORY MEASUREMENTS

all future tests, the static load was restricted to that sufficient to restrain the fixture (about 300 pounds). Time histories of track and laboratory impact strains are compared in Figure 6.

- c. Variation in spacing of the tie supports from 12 to 30 inches produced an increase in strain amplitudes of about 10 percent. Therefore, it was concluded that the spacing was not a critical factor so long as it was maintained constant. A spacing of 12 inches was adopted.

Effect of Pad Stiffness on Strain Attenuation

Selection of Pads for NEC Field Tests

For the EVA pad and eight potential alternatives, the peak bending strains from low-level (non-crack) drops are shown in Figure 7. The left side of the figure shows the results for a cluster of more flexible pads of standard (5-mm) thickness. These results can be compared directly with the curve for EVA #1, the first EVA test pad. The right side of the figure shows similar results for two pads of increased thickness. The two pads were heavily grooved to increase flexibility. Their results can be compared directly with the curve for EVA #2, the second EVA test pad.

The vertical force-deflection characteristics of each pad were measured statically and at loading/unloading rates up to 9 cycles per second. For each pad, a value of "dynamic stiffness" was determined as the slope of the line connecting 4,000 and 20,000 pounds during the pad compression portion of the dynamic loading cycle. Figure 8 shows the dynamic load-deflection results for the three pads which were later selected for field testing.

From comparable peak bending moments at each drop height in Figure 7, a mean percentage bending moment reduction was calculated for each alternative pad. The static and dynamic values of pad stiffness were obtained from load-deflection plots of the type illustrated in Figure 8. The results are compiled in Table 1 along with stiffness values for a number of pads which were not selected for impact testing.

While the results show a general increase in impact attenuation as pad stiffness decreases, the trend is not monotonic. The dynamic stiffness measurement cannot be depended upon to indicate the ability of a pad to attenuate impact strain. There are several possible causes for this lack of correspondence:

- a. The impact phenomena occurs much more rapidly than the stiffness measurement at 9 Hz. It is possible that some materials continue to stiffen with increase in loading rate.

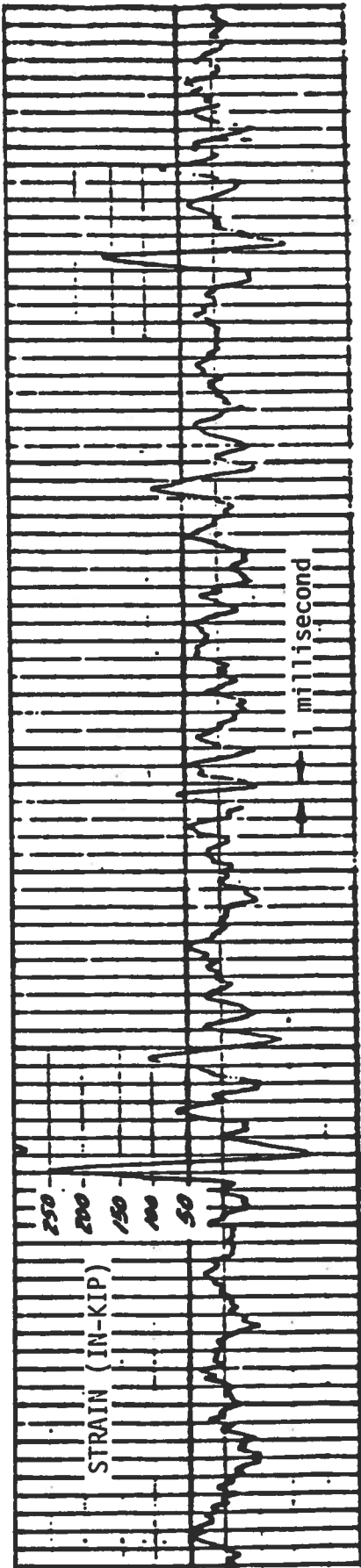

(a) Track Measurement

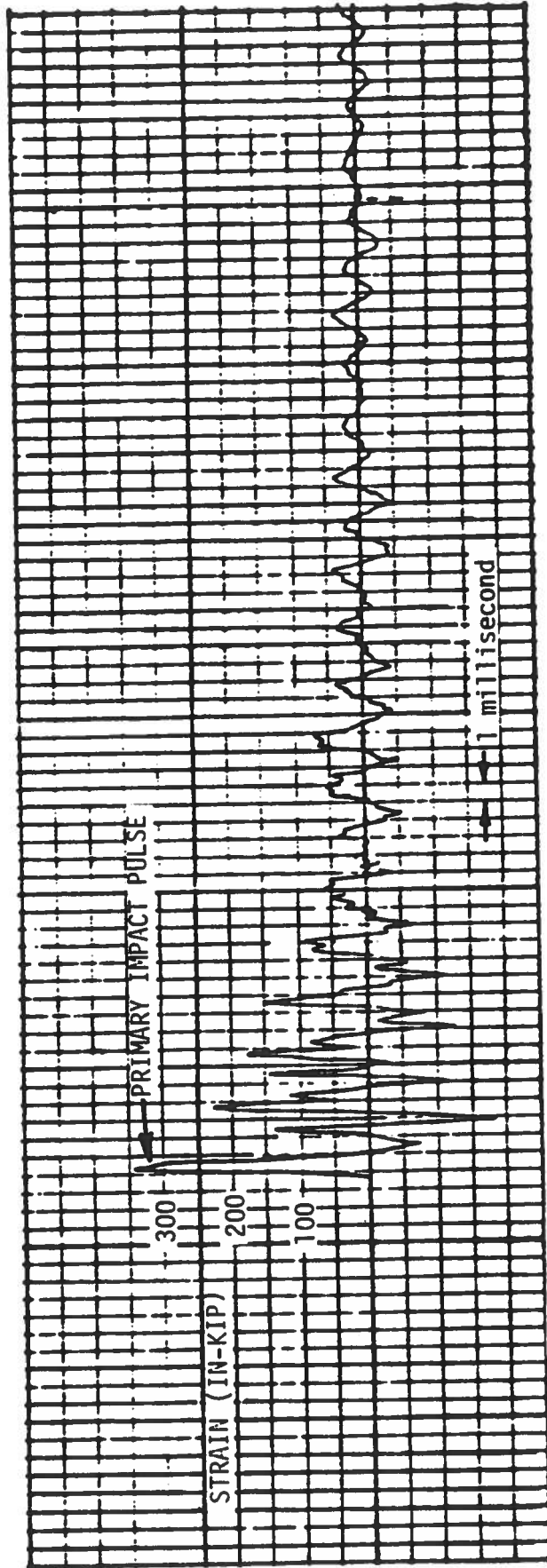

(b) Laboratory Measurement

FIGURE 6. TYPICAL TIME HISTORIES OF TIE STRAIN FROM TRACK AND LABORATORY MEASUREMENTS

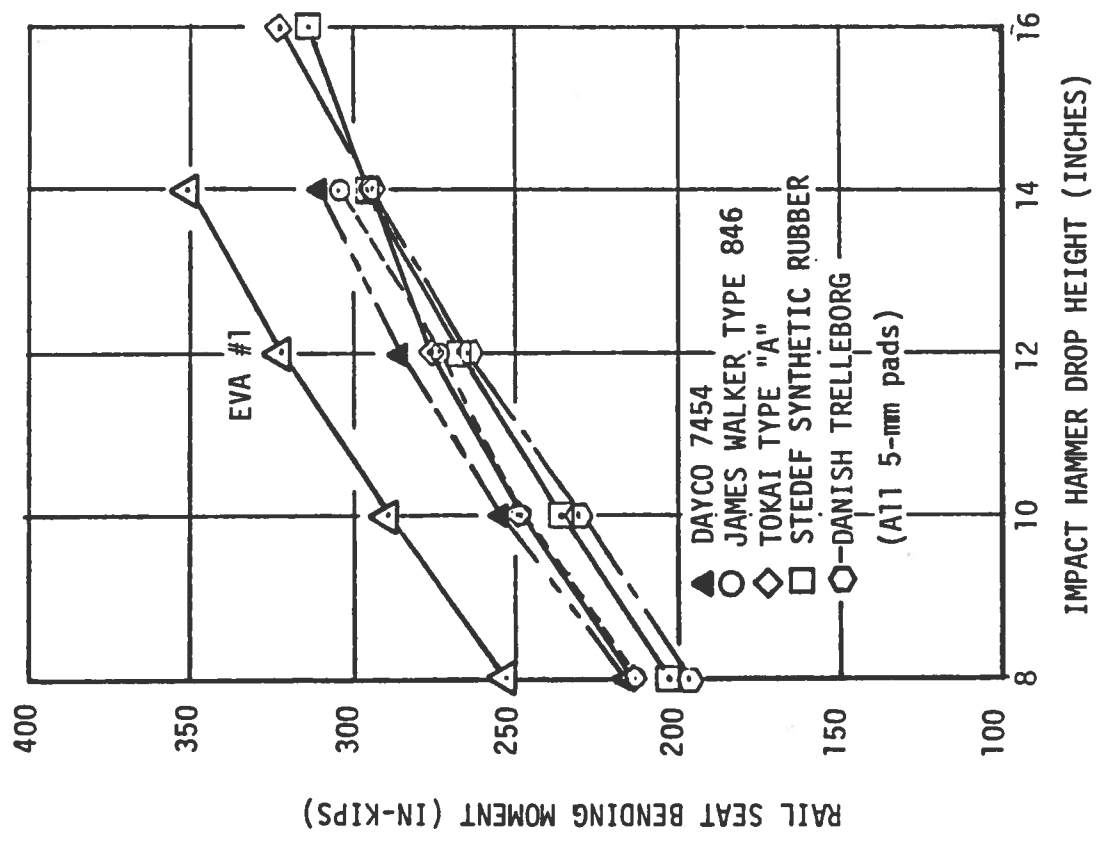
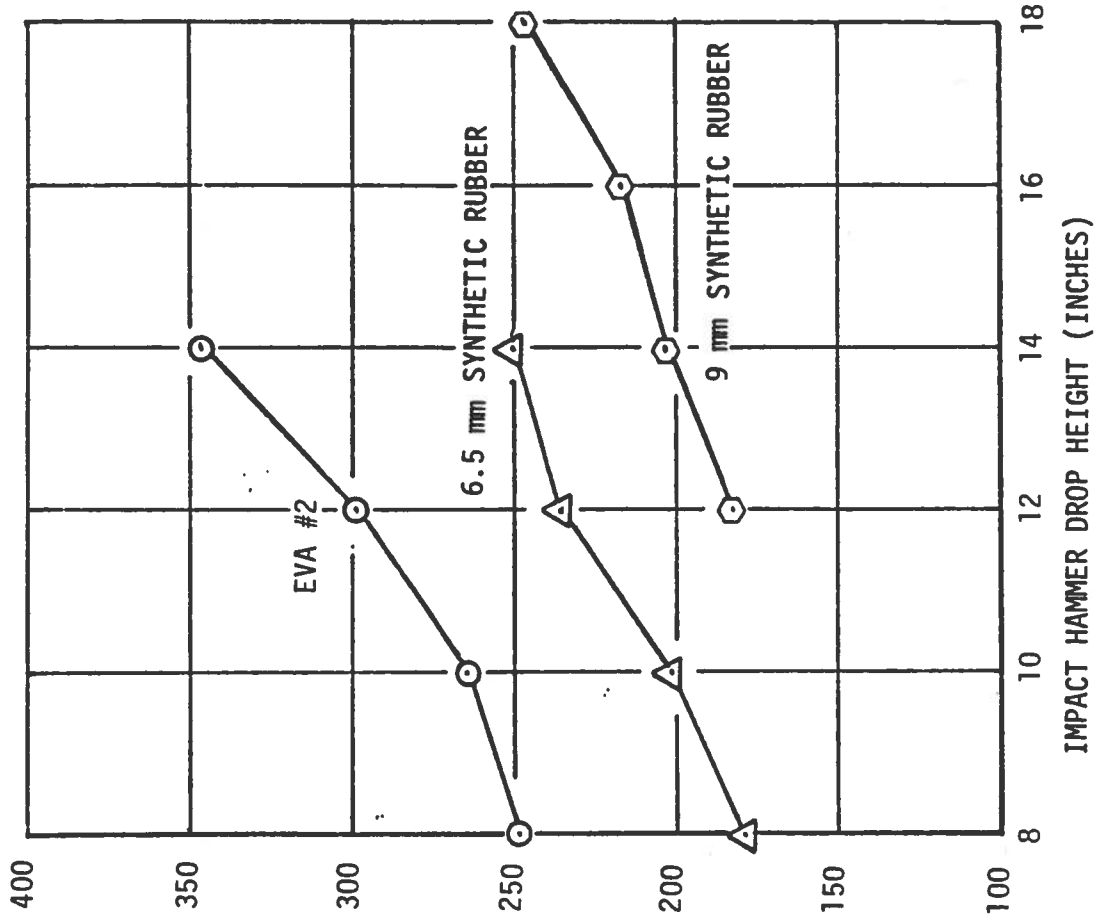

FIGURE 7. EFFECT OF TIE PAD SUBSTITUTIONS ON IMPACT BENDING MOMENT AT TIE RAIL SEAT

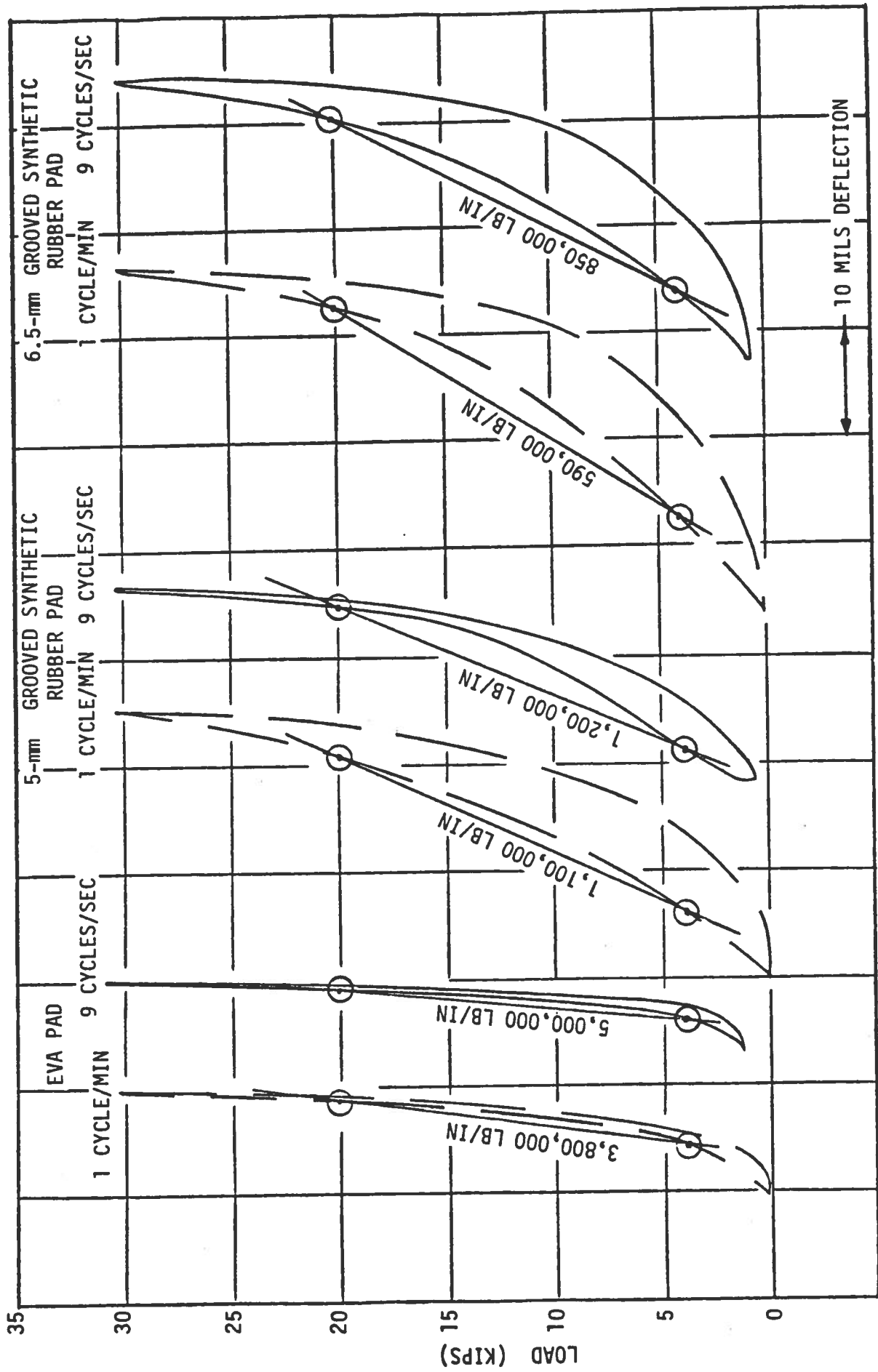
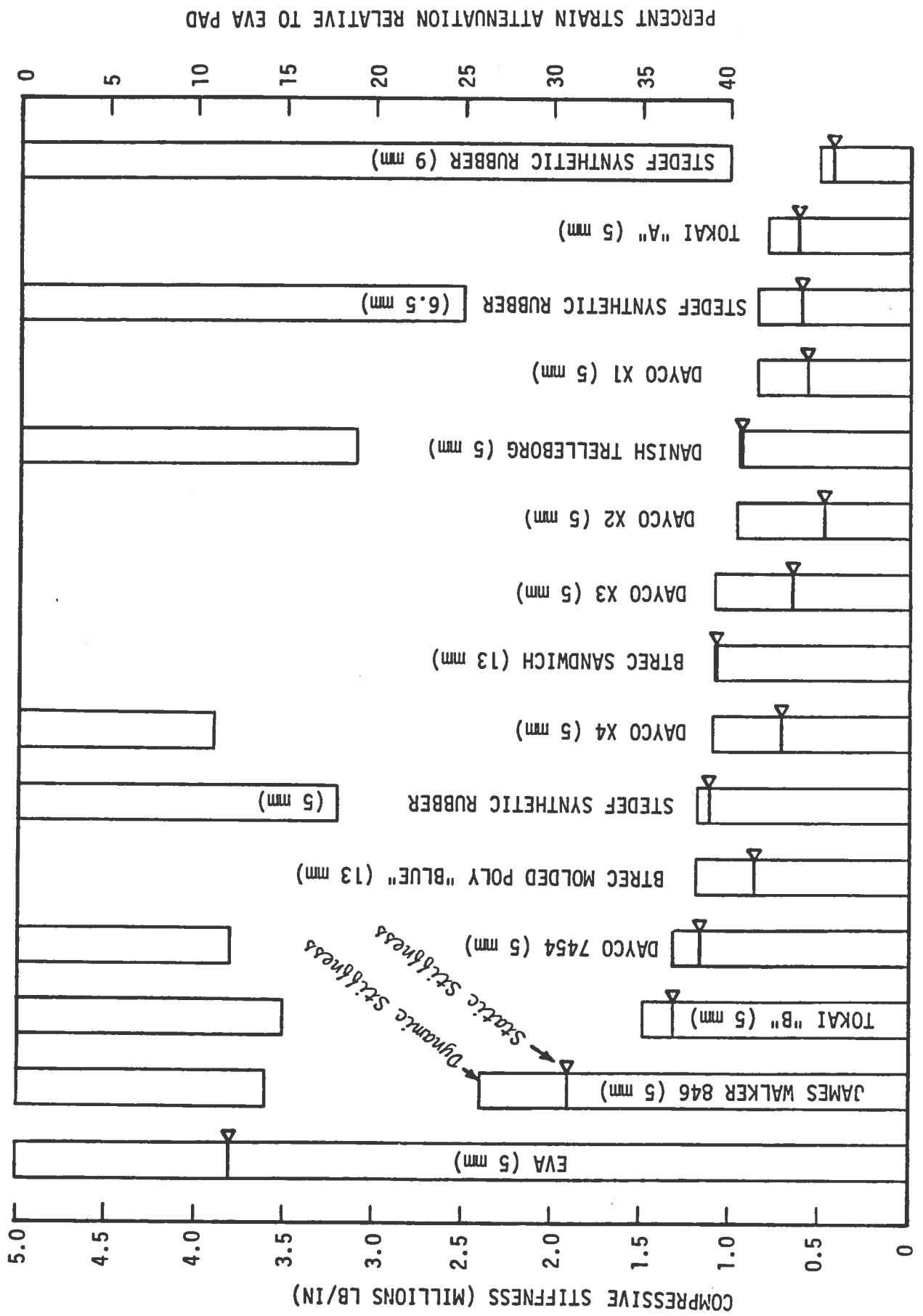

FIGURE 8. TYPICAL LOAD-DEFLECTION PLOTS FROM TIE PAD STIFFNESS MEASUREMENTS

TABLE 1. TIE PAD STIFFNESS AND IMPACT ATTENUATION RATES FROM BASIC TESTS



- b. Some pads experience rapid stiffening in the load range above 20,000 pounds. A stiffness index calculated from a higher load range might produce better correlation. The slopes of the load-deflection curves between 20,000 and 30,000 pounds were checked and showed no general improvement in correlation.

The lack of correspondence between impact attenuation and stiffness indicates that the attenuation rate of a given pad can only be obtained by laboratory impact tests or field measurements of impact strain.

However, the stiffness measurement is valuable as a measure of the change in condition which may occur in a pad as the result of testing or service loads. JNR results show an increase of two-thirds in the stiffness of Tokaido Shinkansen Type A pads over an expected 10-year life (from 90 tons/cm or 500,000 lb/in to 150 tons/cm or 840,000 lb/in [4]).

Additional Impact Attenuation Tests

Additional impact attenuation tests were sponsored by a pad manufacturer (Dayco Corp.). With the sponsor's permission, the tests are included here because they reveal important facts about the relationship between pad stiffness and impact attenuation. The test procedure was essentially identical to that for the first series of tests.

A summary of dynamic pad stiffness (10-Hz load rate) and impact attenuation is shown in Table 2. The previously used EVA Pad #2 was again tested to provide a reference against which the attenuations of the flexible pads were compared. However, the dynamic stiffness measurements revealed that this pad has stiffened substantially as a result of the original laboratory impacts. The original stiffness of approximately 5 million lb/in had increased to 8.4 million lb/in. Although there was no obvious physical damage to the pad, the impacts had apparently produced a permanent set.

To obtain a reference which more closely matched that for the first tests series, a new EVA pad was also subjected to the impact and dynamic stiffness tests. This pad demonstrated impact attenuation of 6 percent relative to the used EVA pad, and its dynamic stiffness was 4.3 million pounds per inch vs. 8.4 for the used pad.

A previously used 6.5-mm synthetic rubber pad was also included in the tests. This pad had stiffened from 850,000 lb/in to 1.1 million lb/in but showed an improvement in performance against the original (but now much stiffer) EVA pad, from 25-percent impact attenuation (Table 1) to 29-percent (Table 2). Relative to the new EVA pad, the synthetic rubber pad attenuated impact bending strain by 23 percent. A somewhat reduced performance against the new EVA pad could be expected, since the new EVA pad was about 10-percent more flexible than was the original pad in new condition. These results indicated that the impact attenuation capability of the synthetic rubber pad was approximately the same as that found in the first series of tests, although its dynamic stiffness had increased by 29 percent.

TABLE 2. TIE PAD STIFFNESS AND IMPACT ATTENUATION RATES FROM ADDITIONAL TESTS

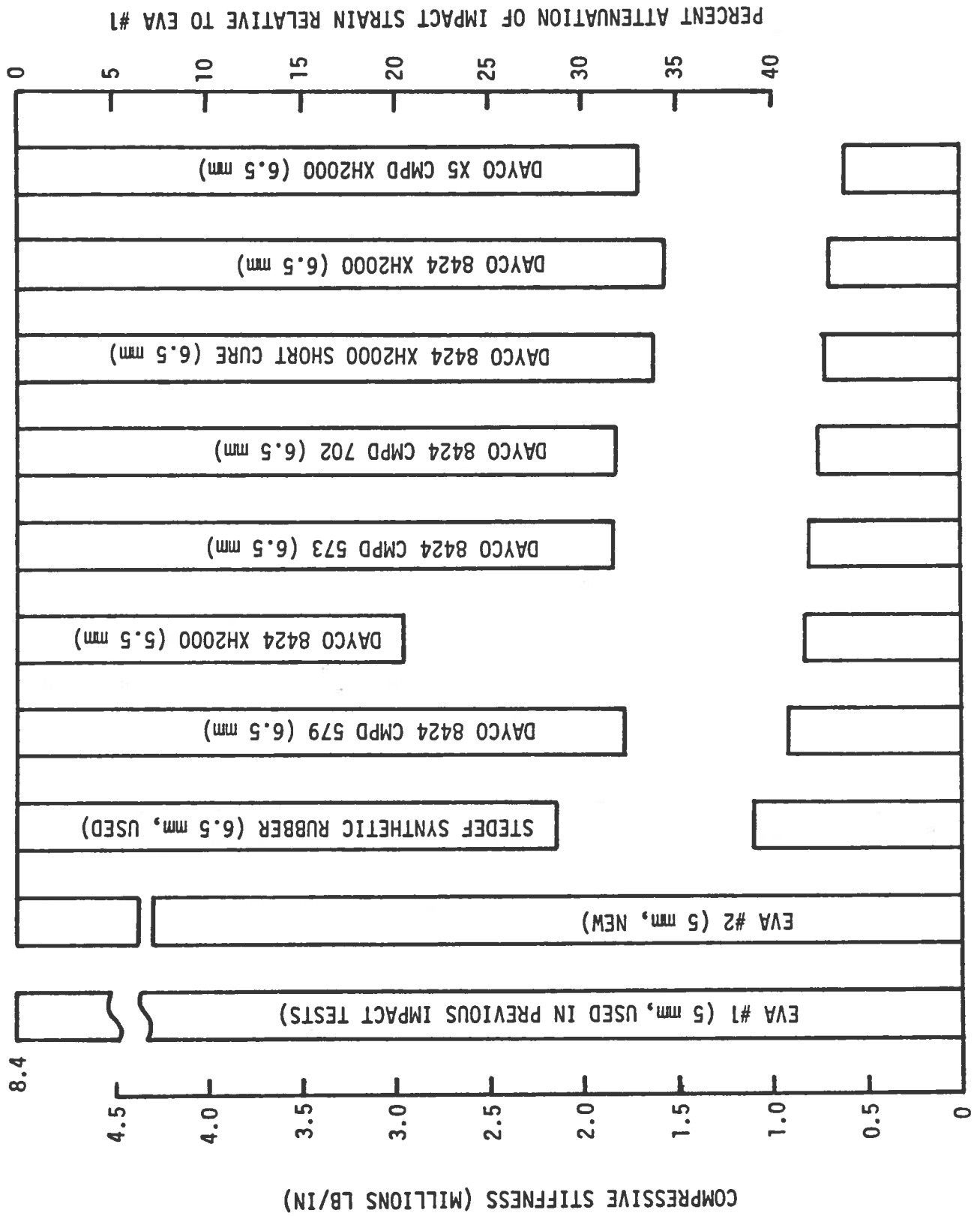

The results for seven variations of Dayco tie pads are also shown in Table 2. Although the dynamic stiffness of these pads varied widely, the most important parameter regarding impact attenuation was pad thickness. The 5.5-mm pad performed poorly relative to the other flexible pads, all of which had 6.5-mm thickness. Relative to the new EVA pad, a maximum strain attenuation rate of 28 percent was found among the 6.5-mm pads. All of the Dayco pads were new.

The additional tests demonstrate that dynamic stiffness as currently measured provides a very unreliable measure of strain attenuation capability. However, the stiffness measurements are useful as an indicator of the change in condition which may have taken place in a given pad as the result of testing or service.

Tests Under Worst-Case Impacts

The next objective was to determine whether a practical level of pad stiffness could be expected to prevent cracks in a tie subjected to the highest level of impact bending moment (600 inch-kips) measured in track. However, the drop height required to deliver the maximum strain with the EVA pad was not known and could not be determined without cracking the tie. Therefore, a test series 3 was conducted in the following sequence:

- a. Tests with the EVA #2 pad at drop heights of 8 and 14 inches, to reestablish a baseline after an interim of two weeks.
- b. Tests with the 9-mm and 6.5-mm synthetic rubber pads, respectively, up to about 400 inch-kips of dynamic bending moment (possibly above the crack threshold)
- c. Final tests with the EVA #2 pad at drop heights from 14 to 20 inches, where the bending moment level exceeded 600 inch-kips.

The data for this test series (Test 3) are shown in Figure 9, along with directly comparable data from Figure 7 (Test 2).

It should also be noted that the impact fixture was relocated between the conduct of Tests 2 and 3. The method of frame suspension was changed from a centerline (ideal) arrangement to a 4-bolt arrangement which could produce frame tilt. Careful realignment of the frame was required to regain consistency in bending moment levels at a given drop height. The hammer head was rotated by 90 degrees to produce single-point contact with the rail head, instead of the former linear contact. These changes could have caused a minor shift in comparative dynamic bending moment levels.

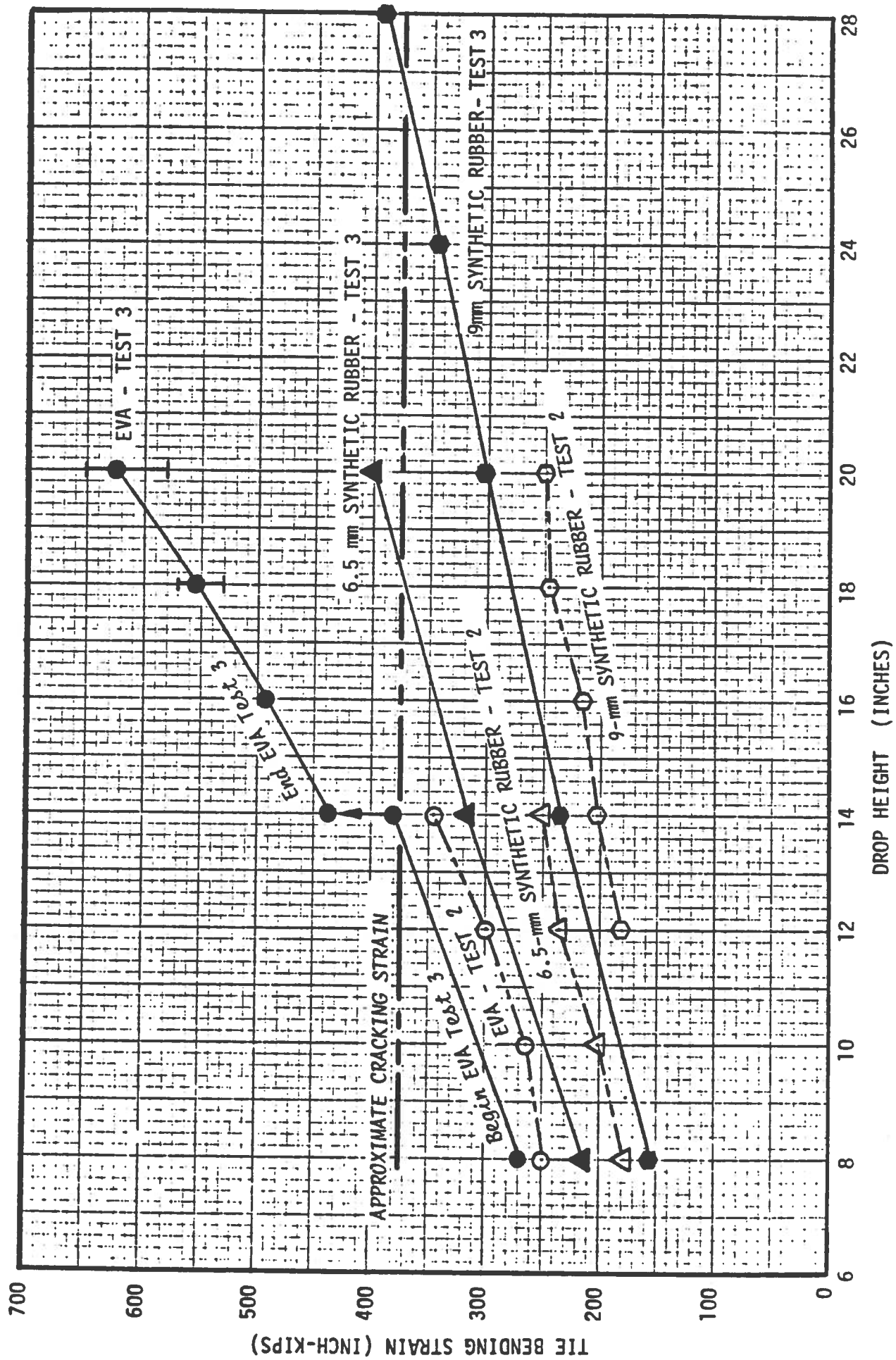

FIGURE 9. TIE BENDING MOMENT vs. DROP HEIGHT FOR TESTS UP TO MAXIMUM SIMULATED TRACK INPUT

An additional, major increase in comparative dynamic bending moment levels can be seen in the series 3 tests with the EVA pad. Fourteen-inch drops were conducted immediately before and after tests with the synthetic rubber pads. The two sets of drops produced an increase in the mean peak bending moment of 65 inch-kips. Such an increase can only be attributed to the development of a crack under the gage coupon. Since the faces of this tie were not Stresscoated, there was no visual identification of a crack during these tests, although the faces were regularly inspected.

Although cracking apparently existed during all series 3 tests and resulted in upward drift of the bending moment levels from equal impacts, several pertinent observations can be made about the data in Figure 9:

- a. The following combinations of pad and drop height produced approximately equivalent levels of mean peak bending moment:
 - (1) EVA pad at 14 inches (overall mean = 408 inch-kips)
 - (2) 6.5 mm pad at 20 inches (400 inch-kips)
 - (3) 9 mm pad at 28 inches (392 inch-kips).
- b. A linear projection of the curve marked "EVA - TEST 2" would exceed 600 inch-kips at the 28-inch drop height. Therefore, from the most conservative assessment of the data, it can be projected that the 28-inch height with the EVA pad simulates the worse-case condition measured in track (600 inch-kips). It is possible that the bending moment magnification, which is evident in the post-crack EVA data, is also present in track measurements. If so, the worst case track conditions could be represented by the 20-inch drop height with the EVA pad.
- c. It can be concluded from the data that a pad equivalent to the 9-mm pad in new condition (500,00 lb/in = 90 tons/cm) is the best choice to prevent cracks under all but the most extreme conditions. Also, a pad having the stiffness provided by the 6.5-mm pad in new condition (850,000 lb/in = 152 tons/cm) should prevent cracks under all but the most extreme conditions.
- d. The rate at which a pad stiffens over its lifetime depends on the pad material and the environment. These must be considered. The JNR found that the Tokaido Shinkansen Type A pad, with a nominal stiffness of 90 tons/cm (500,000 lb/in) in new condition, deteriorated to 150 tons/cm (840,000 pounds/inch) in the expected 10-year life of the pad [4]. This constitutes a stiffness increase of two-thirds. Therefore, it is imperative to use materials which retain their elasticity and to obtain the lowest practical stiffness of the pads in new condition. The stiffness of 90 tons/cm (500,000 lb/in) is the lowest value used by the JNR for pads of 4.5 mm thickness. Finally, the final selection of a

pad having the lowest practical stiffness must include an evaluation of the effect of increased rail-to-tie deflection on the performance of the fastener clips--a tradeoff decision.

Destructive Tie Tests

Noninstrumented, destructive impact tests were conducted on two NEC ties to determine the range of drop height required to produce advanced cracks of the type found in track. The rail seat areas of each tie face were Stress-coated. One end of each tie was impacted at heights varying from 14 to 36 inches using 2-inch increments from 14 to 20 inches and 4-inch increments thereafter.

An impact procedure was developed during the tests. In most cases, a detectable crack extension would emerge after 3 to 10 repetitions at a given drop height. Further repetitions at the same drop height would produce relatively little additional extension. Therefore, a procedure was adopted in which 10 drops were made at each height, with inspections after the third and tenth drops.

Crack progression under the impacted rail seats is shown for three ties in Figure 10. Cracks were first detected at the drop height of 16 inches on the two NEC ties (and earlier on the RT 7SS tie) and at 18 inches on the latex modified BW-3 tie. Total crack height for the BW-3 tie fell slightly below that of the mean of the two NEC ties. Further tests would be required to determine whether the differences in crack initiation height or total height constituted a statistically significant difference in crack resistance.

After completion of the first test (Tie 0432), it was discovered that cracks had developed at the nonimpacted rail seat as well as the impacted rail seat. Subsequent tests produced the same result. In each case, total crack height on the nonimpacted end was 70 to 80 percent of the total crack height on the impacted end. Maximum crack heights for the two ends of each tie are compared in the box of Figure 10. This result demonstrates that a stress wave propagates across the tie with little attenuation of the initial amplitude.

It should be pointed out that without the Stresscoat applied to the tie faces, few if any of the laboratory cracks would have been detected. In contrast, cracks on ties in track were visible either with an alcohol spray or with no surface treatment. It can be concluded that service-produced cracks are well-developed before they become visible, and that repeated working under normal service loads causes the cracks to widen.

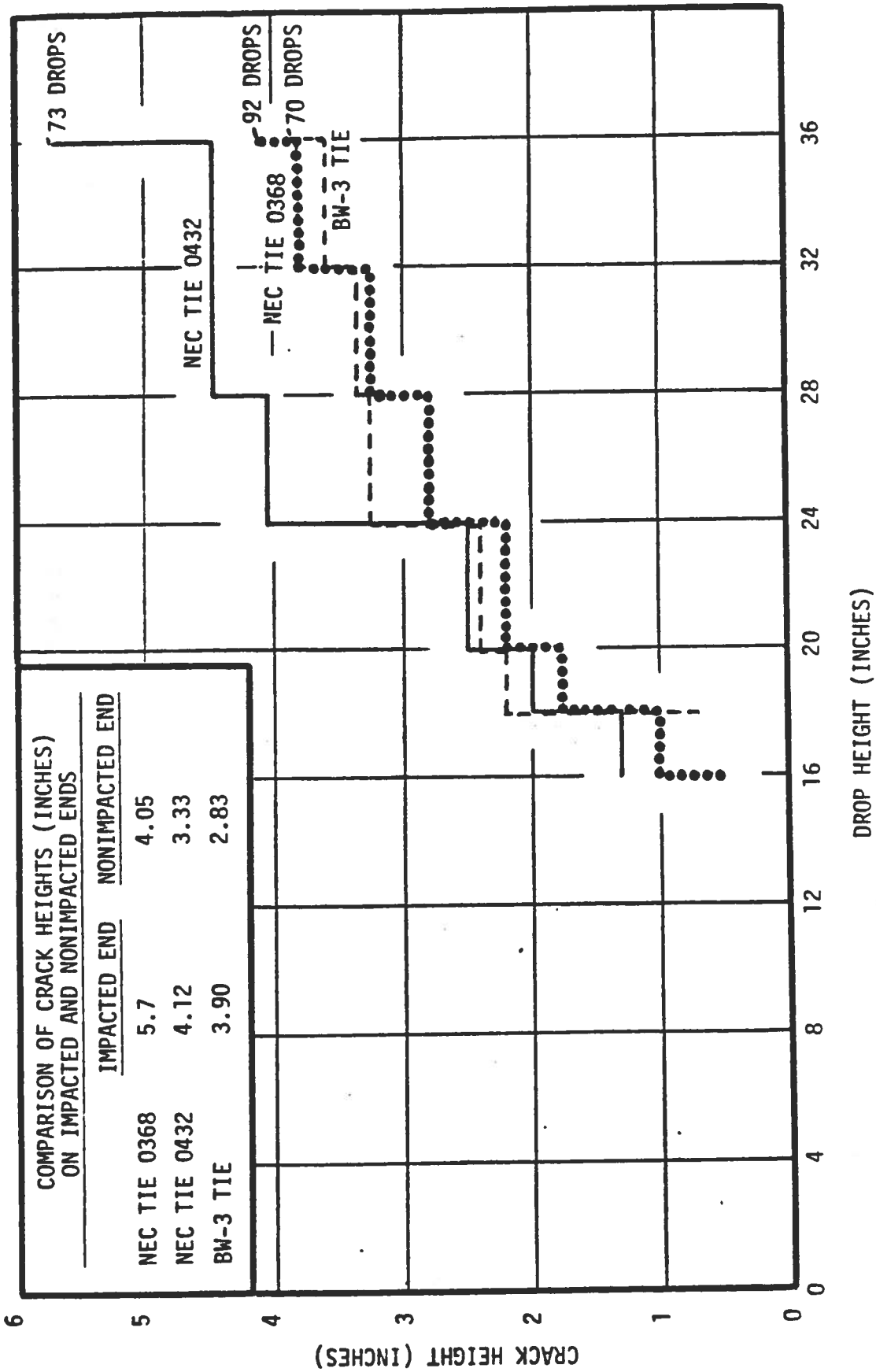

FIGURE 10. TIE CRACK DEVELOPMENT VS. IMPACT HAMMER DROP HEIGHT

CONCLUSIONS

- a. The results of the laboratory tie impact tests indicate that a reduction of tie pad stiffness (measured dynamically for loads between 4,000 and 20,000 lb) from the present 5 million lb/in to approximately 500,000 lb/in may prevent the development of cracks in concrete ties on the Northeast Corridor. However, this performance was obtained with a 9-mm pad. The tests showed that the stiffness as currently measured did not provide a reliable measure of impact attenuation, and that the thickness of the pad must be considered.
- b. The field measurements planned to verify this laboratory study have now been completed [3]. Pad substitutions in track produced significant attenuations of impact loads at given rates of occurrence. However, none of the trial substitute pads completely eliminated the occurrence of impact loads above the cracking threshold. From the field study, it was concluded that the elimination of cracking can only be produced by a combination of more flexible pad and a program to eliminate the worst wheel tread conditions.
- c. Many observers have believed that the substitution of a more flexible pad would cause an increase in rail-to-tie deflection. Such an increase could cause the exceedance of the fatigue limit of the elastic fastener clips. However, recent measurements of rail/tie deflection on a curve at Aberdeen, Md. indicate that the peak-to-peak deflections on soft pads are actually lower than those on the rigid EVA pads [3]. This is due to the fact that less uplift occurs with the flexible pads and to a better balance between gage and field side deflections as the pad absorbs rollover.
- d. Data from the Japanese National Railway show that pad stiffness can increase by about two thirds over an expected pad life of 10 years [4]. While such an increase with a pad having an initial stiffness of 500,000 lb/in would still provide better strain attenuation than is currently available, it would not assure crack prevention for the entire 10-year life.
- e. The evaluation of earlier Northeast Corridor data [1] show that tie strains equivalent to the bending strength of the ties are produced almost exclusively by high-speed passenger trains. These strain levels occur on each tie for about 0.1 percent of the passenger train axles, a frequency equivalent to about one axle every 1.8 days. A procedure to eliminate the worst wheel conditions from high-speed passenger traffic would substantially reduce the development of tie cracks. This improvement, together with the installation of a pad having reduced stiffness, should eliminate most cracked ties which result from impacts caused by either wheel or rail irregularities.

- f. After initiation of a crack, continued propagation requires increasing levels of impact strain. Static bending tests [5,6] have shown that ties cracked up to the top level of the prestress strands do not suffer a significant loss of ultimate strength. This indicates that it may not be necessary to prevent crack initiation but only the propagation of the cracks to failure.

REFERENCES

- [1] Tuten, J.M., "Analysis of Dynamic Loads and Concrete Tie Strain Data from the Northeast Corridor Track", technical memo by Battelle's Columbus Laboratories to the Federal Railroad Administration, Improved Track Structures Research Division, Contract DOT-FR-9162, May 1981.
- [2] Harrison, H.D., Progress Report for March 1981 on Contract No. DOT-FR-8164, "Tie and Fastener Performance and Correlation Analysis", by Battelle's Columbus Laboratories to the Federal Railroad Administration, Improved Track Structures Research Division.
- [3] Dean, F. E., Harrison, H. D., Prause, R. H., and Tuten, J. M., "Investigation of the Effects of Tie Pad Stiffness on the Impact Loading of Concrete Ties in the Northeast Corridor", report by Battelle's Columbus Laboratories to the Federal Railroad Administration, Improved Track Structures Research Division, Contract DOT-FR-9162, January 1982.
- [4] Watanabe, K., "Engineering of Rail Fastening", Japanese Railway Engineering, Vol. 19, No. 4, 1980.
- [5] Dean, F. E., "Tests to Determine the Effects of Service Loading on the Bending Strength of Concrete Ties", Transportation Test Center FAST Report No. 81/11, December, 1981.
- [6] "Static Tests at Littleton, Mass.", National Railroad Passenger Corporation memo from D. L. Jerman to D. C. Wilcox, December 16, 1980.